



INFINITI®

2018 Q50 HYBRID

First Responder's Guide



Foreword

This manual describes first response operations and **important safety** related warnings and cautions for this vehicle.

This vehicle is equipped with a high-voltage battery pack. **Failure to follow recommended practices during emergency responses will cause death or serious personal injury.**

Please read this manual in advance in order to understand the features of this vehicle and to help you deal with incidents involving this vehicle. Follow the procedures in order to help assure a successful first response operation.

This manual is periodically updated. If you are not viewing this manual on the Infiniti web site, we urge you to go to www.infiniti.com or www.infiniti-techinfo.com to make sure you have the most recent version of this manual.

INFINITI EMERGENCY CONTACT INFORMATION

- Infiniti Consumer Affairs: 1-800-662-6200 (US) or 1-800-361-4792 (Canada)
- Hours of operation are 8am - 5pm (Monday-Friday) Eastern, Central and Pacific time zones

IMPORTANT INFORMATION ABOUT THIS MANUAL

You may see various symbols in this manual. They have the following meanings:



⚠ DANGER

This symbol is used to inform you of an operation which will result in death or serious personal injury if instructions are not followed.

Example: Touching high-voltage components without using the appropriate protective equipment will result in electrocution. PPE must always be worn when touching or working on high-voltage components.

⚠ WARNING

This symbol is used to inform you of an operation which may cause death or serious personal injury if instructions are not followed.

⚠ CAUTION

This symbol is used to inform you of an operation which may cause personal injury or component damage if instructions are not followed.

Please note that there may be differences between this manual and the vehicle specification due to specification changes.

Table of Contents

FOREWORD	FRG-2
INFINITI EMERGENCY CONTACT INFORMATION	FRG-2
IMPORTANT INFORMATION ABOUT THIS MANUAL	FRG-2
1. ABOUT THE INFINITI Q50 HYBRID	FRG-5
1-1 Q50 HYBRID IDENTIFICATION	FRG-6
1-1.1 EXTERIOR AND ENGINE COMPARTMENT	FRG-6
1-1.2 INTERIOR	FRG-7
1-2 VEHICLE IDENTIFICATION NUMBER (VIN) LAYOUT	FRG-8
1-3 WARNING AND INDICATOR LAMP INFORMATION	FRG-9
2. BASIC HIGH-VOLTAGE SYSTEM AND 12-VOLT SYSTEM INFORMATION	FRG-10
2-1 BATTERY INFORMATION	FRG-10
2-1.1 12-VOLT BATTERY	FRG-10
2-1.2 HIGH-VOLTAGE BATTERY	FRG-10
2-2 HIGH-VOLTAGE-RELATED AND 12-VOLT-RELATED COMPONENT LOCATIONS AND DESCRIPTIONS	FRG-11
2-3 HIGH-VOLTAGE BATTERY PACK SPECIFICATIONS	FRG-12
2-4 HIGH-VOLTAGE SAFETY MEASURES	FRG-12
2-4.1 WARNING LABELS	FRG-13
2-5 HIGH-VOLTAGE SAFETY SYSTEM	FRG-14
2-6 HIGH-VOLTAGE CIRCUIT SHUT-OFF SYSTEM	FRG-16
2-7 PREVENTING ELECTRICAL SHOCK	FRG-16
2-8 EMERGENCY MEDICAL EQUIPMENT	FRG-16
3. EMERGENCY RESPONSE STEPS	FRG-17
3-1 PREPARATION ITEMS	FRG-17
3-1.1 PERSONAL PROTECTIVE EQUIPMENT (PPE) PROTECTIVE WEAR CONTROL ...	FRG-18
3-1.2 DAILY INSPECTION	FRG-18
3-1.3 INSULATED TOOLS	FRG-18
3-2 VEHICLE IMMOBILIZATION AND STABILIZATION	FRG-19

3-3	HOW TO HANDLE A DAMAGED VEHICLE AT AN ACCIDENT SCENE	FRG-20
3-3.1	HIGH-VOLTAGE SYSTEM SHUT-DOWN PROCEDURE	FRG-21
3-3.2	WATER SUBMERSION	FRG-31
3-3.3	VEHICLE FIRE	FRG-32
3-3.4	CUTTING THE VEHICLE BODY	FRG-32
3-3.5	HIGH-VOLTAGE BATTERY DAMAGE AND FLUID LEAKS	FRG-36
3-3.6	ACCESSING THE OCCUPANTS	FRG-37
3-4	STORING THE VEHICLE	FRG-38
4.	EMERGENCY QUICK REFERENCE GUIDE	FRG-39

1. About the INFINITI Q50 HYBRID

This hybrid electric vehicle (HEV) uses two types of batteries. One is a 12-volt battery that is the same as the battery in vehicles powered by internal combustion engines. The 12-volt battery is located behind the rear seat back with battery cable access through the trunk area. The other is the high-voltage battery for the traction motor which propels the vehicle. The high-voltage battery is located behind the rear seat back with service plug access through the trunk area.

When the high-voltage battery level is low, engine output is used to generate power from the traction motor and charge the high-voltage battery. Additionally, the vehicle system can recharge the high-voltage battery by converting driving force into electricity while the vehicle is decelerating or being driven downhill. This is called regenerative charging.

1-1 Q50 HYBRID IDENTIFICATION

1-1.1 Exterior and Engine Compartment

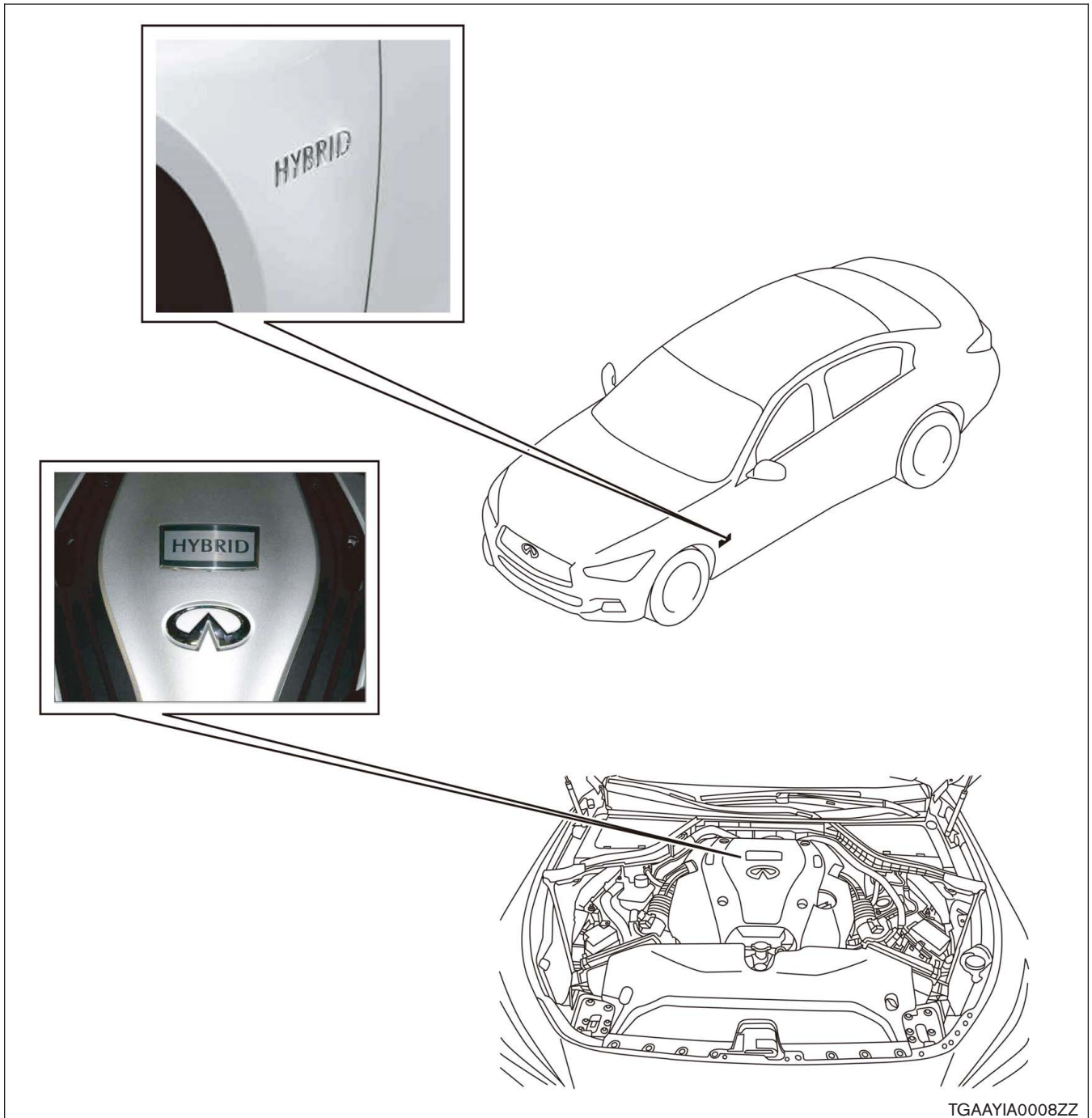

1-1.2 Interior

Interior components referenced in this manual are as follows:

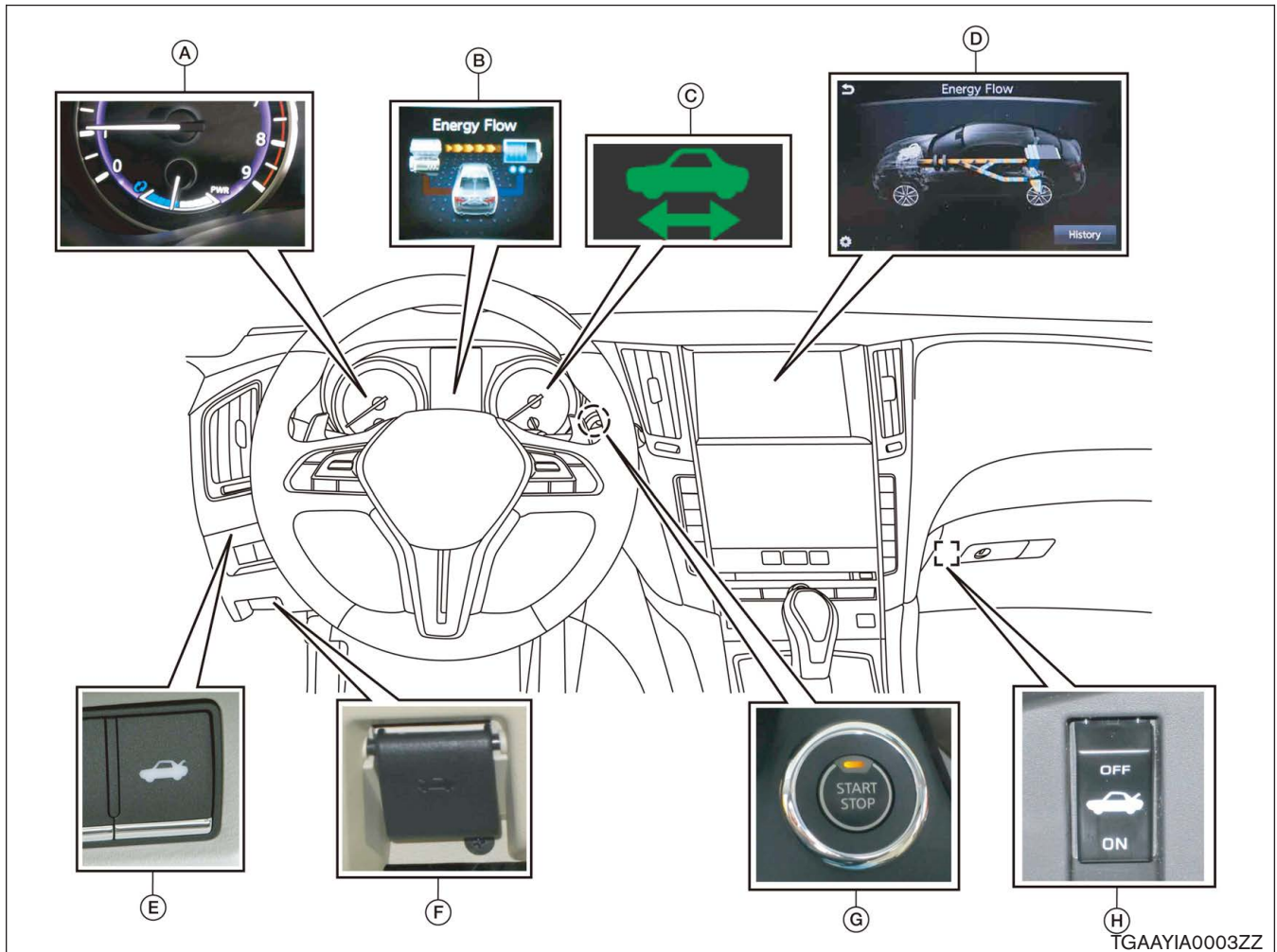

TGAAYIA0003ZZ

A. Assist charge gauge

B. Energy flow display *1

C. READY indicator (green)

D. Energy flow display *1

E. Trunk lid release switch

F. Hood release handle

G. START/STOP switch and ON indicator lamp (orange)

H. Trunk release power cancel switch

*1: This screen may not be displayed due to customer settings.

1-2 Vehicle Identification Number (VIN) Layout

In exterior appearance the Q50 HYBRID is nearly identical to the conventional Infiniti Q50 series vehicles.

The vehicle identification number can be located as follows:

Example VIN : JN1 **A**V7AP4JM690008

The Q50 HYBRID is identified by the 4th alphanumeric character: **A**

A = Q50 HYBRID

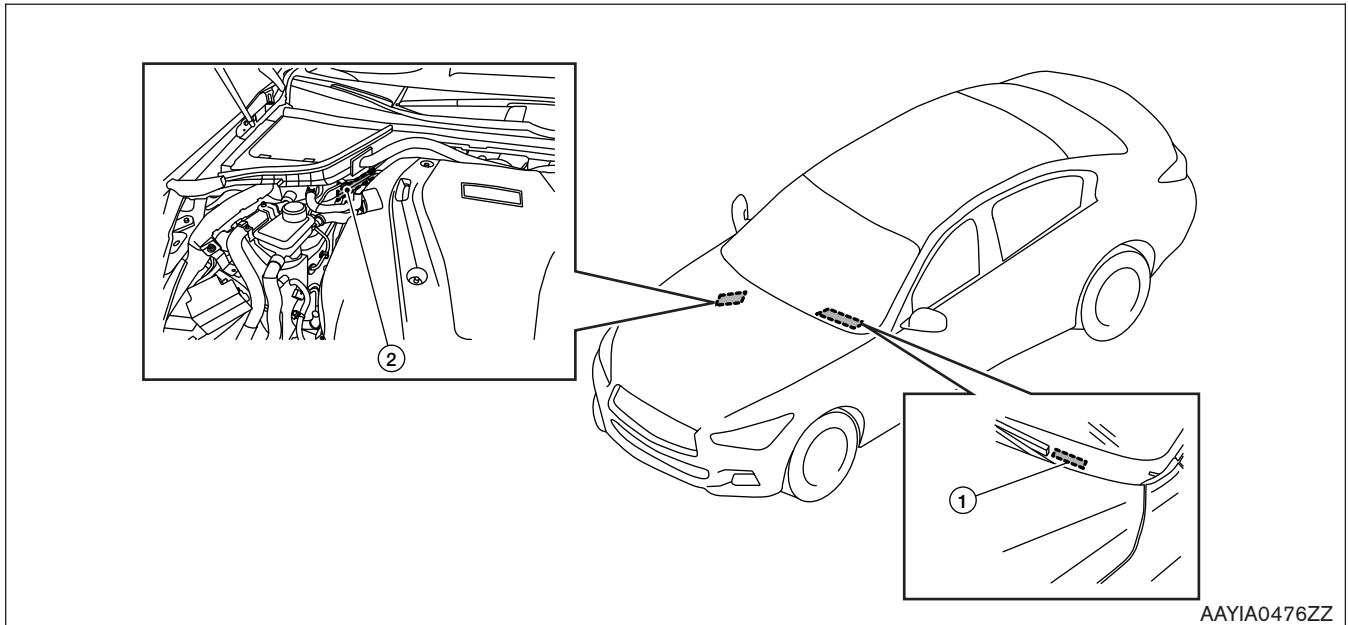

1. VIN plate (visible through windshield)

2. Chassis number

1-3 Warning and Indicator Lamp Information

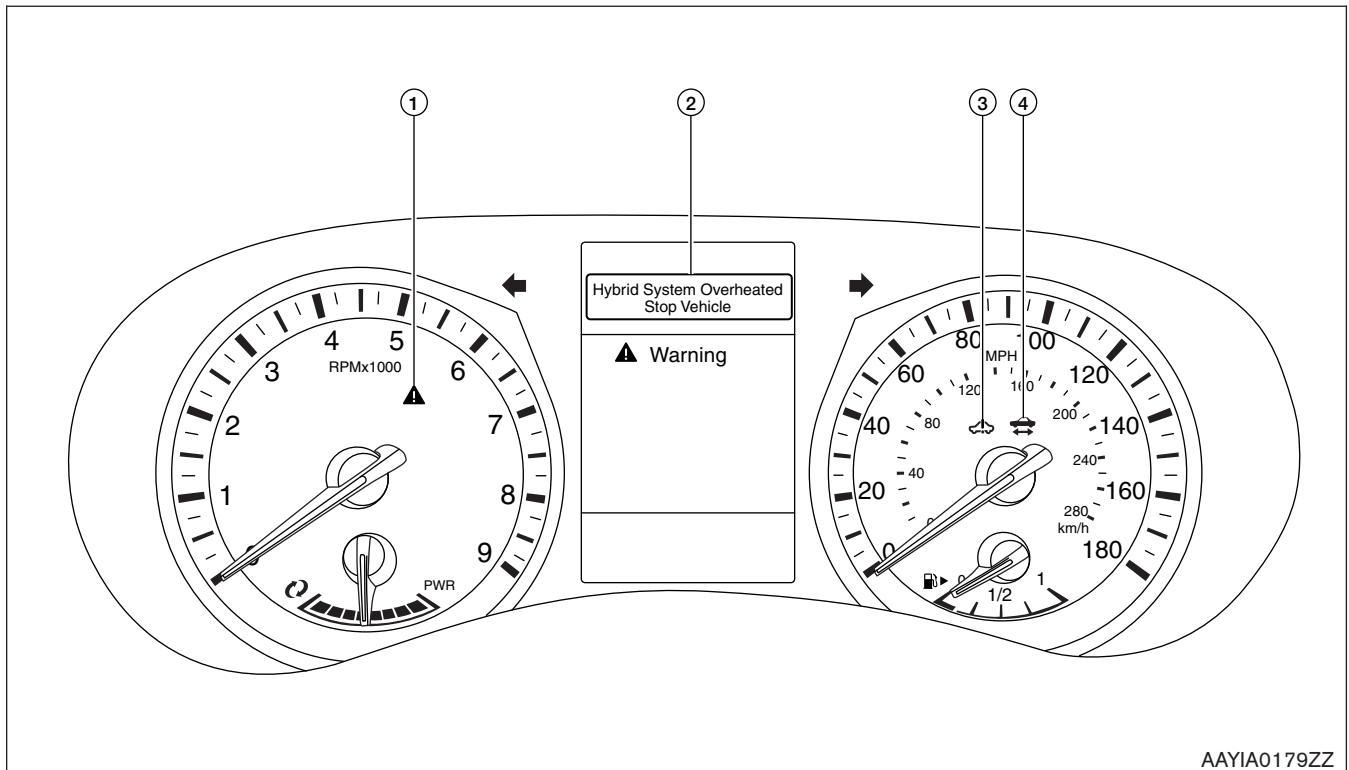

AAYIA0179ZZ

1. Master Warning Lamp (Orange or Red)

2. Hybrid System Overheated Stop Vehicle Warning (Vehicle Information Display)

3. Hybrid System Warning Lamp (Orange)

4. READY Indicator (Green)

Lamp Name	Icon	Description
READY Indicator (Green)		This lamp is on when the high-voltage system is powered up and the vehicle is ready to drive.
Master Warning Lamp (Orange or Red)	 	This lamp is on when another warning lamp or message is displayed in the instrument cluster.
Hybrid System Warning Lamp (Orange)		This lamp is on or blinking when: <ul style="list-style-type: none"> ▪ Malfunction has occurred in the hybrid control system and/or ▪ High-voltage leak to vehicle chassis and/or ▪ Emergency shut-off system has been activated. The shut-off system activates in the following conditions: <ul style="list-style-type: none"> – Front and side collisions in which the air bags are deployed. – Certain rear collisions. – Certain high-voltage system malfunctions.

2. Basic High-voltage System and 12-Volt System Information

2-1 Battery Information

The Q50 HYBRID utilizes two batteries in order to supply both high and low voltage.

2-1.1 12-Volt Battery

- The Q50 HYBRID contains a conventional lead-acid 12-volt battery.
- The 12-volt battery is located in the trunk, on the left side, concealed by a trim cover (A).
- The 12-volt battery is charged by the high-voltage battery through the DC/DC converter.

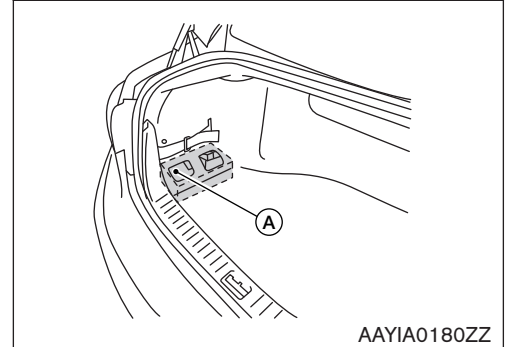

2-1.2 High-voltage Battery

- The Q50 HYBRID contains a high-voltage battery.
- The high-voltage battery is mounted in the trunk area behind the rear seat, enclosed in a metal case and concealed by trim cover.
- The high-voltage battery stores energy at approximately 346 - 400 volts DC.
- A vent hose is provided to exhaust gasses outside the vehicle if necessary.

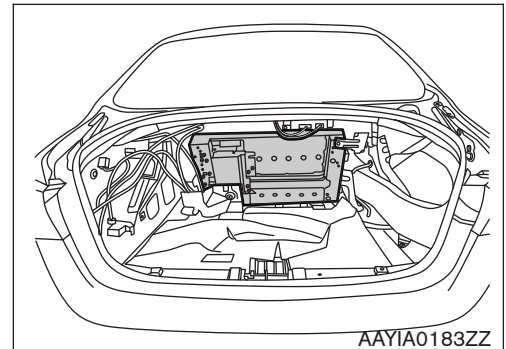

- An air vent (A) is located on the rear left hand lower C-pillar trim for battery cooling.

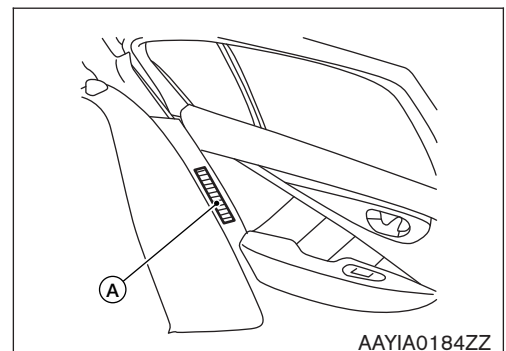

The high-voltage battery supplies power to the following:

- High-voltage harnesses
- DC/DC converter
- Traction motor inverter
- Traction motor
- Electric air conditioner compressor

2-2 High-voltage-Related and 12-Volt-Related Component Locations and Descriptions

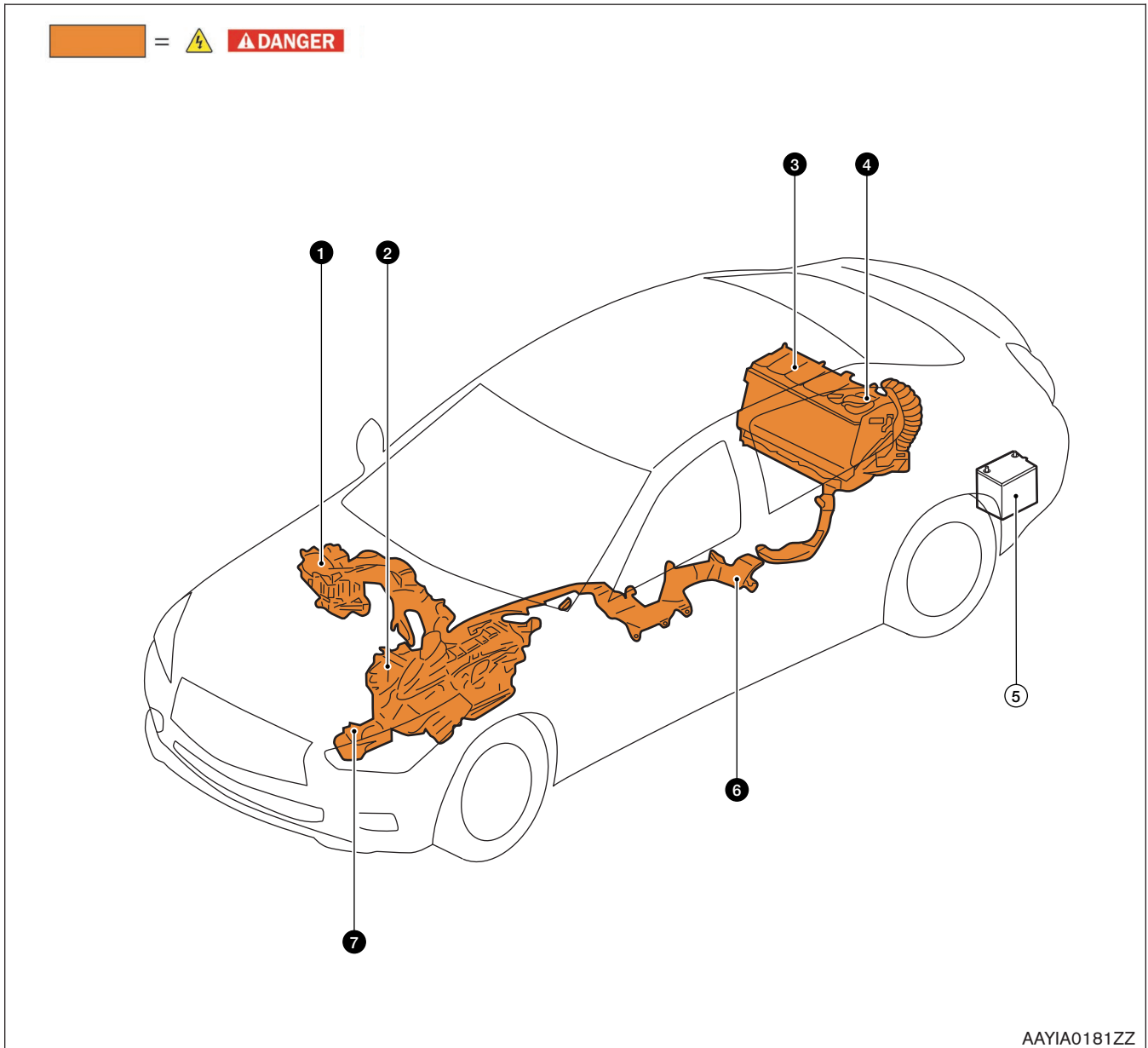

NOTE:

Components with white number in black background are high-voltage components.

No.	Component	Location	Description
①	Traction Motor Inverter	Engine compartment (right rear side)	Converts the DC power stored in the high-voltage battery to three-phase AC power and controls motor torque (revolution) by regulating the motor current. The inverter has a built in high-voltage capacitor.

No.	Component	Location	Description
②	Traction Motor	Built-into the transmission	Converts three-phase alternating current (AC) power to drive power (torque) which propels the vehicle.
③	High-voltage Battery	Trunk area (behind rear seat back)	The high-voltage battery stores and outputs DC power (Maximum voltage 400V) needed to propel the vehicle.
	DC/DC Converter	Trunk area (mounted to top of high-voltage battery)	The DC/DC converter reduces the voltage of the high-voltage battery to provide power to the 12-volt battery in order to operate the vehicle's electric components (headlights, audio system, etc.).
④	Service Plug	Trunk area (below parcel shelf; behind access door in trim panel)	This is used to disable the high-voltage system.
⑤	12-volt Battery	Trunk area (left side behind trim panel)	A lead-acid battery that supplies power to the low voltage devices.
⑥	High-voltage Harnesses	Trunk area (on high-voltage battery), under floor pan, engine compartment	Orange-colored power cables carry high DC voltage between each of the high-voltage components.
⑦	Electric Air Conditioner Compressor	Engine compartment (front driver side)	Air conditioner compressor

2-3 High-voltage Battery Pack Specifications

High-voltage Battery Specifications	
High-voltage battery voltage	346V (400V max.)
Number of high-voltage battery modules in the pack	12 modules (96 cells)
High-voltage battery module voltage	28.8V each
High-voltage battery dimensions	29.63 x 17.81 x 14.85 in. (752.5 x 452.4 x 377.1 mm)
High-voltage battery weight	108.05 lbs (49 kg)

2-4 High-voltage Safety Measures

Circuit insulation	The high-voltage positive (+) and negative (-) circuits are insulated from the metal chassis.
Reducing the risk of electrocution	The high-voltage components and harnesses have insulated cases or orange-colored coverings which provide insulation and easy identification. The high-voltage battery case is electrically connected to the vehicle ground. This connection helps protect the vehicle occupants and emergency responders from high-voltage electrical shock.
Identification	The high-voltage components are labeled "WARNING" similar to the label shown below. All high-voltage harnesses are coated in orange.

2-4.1 Warning Labels

The following labels are applied to the air duct located in the engine compartment.

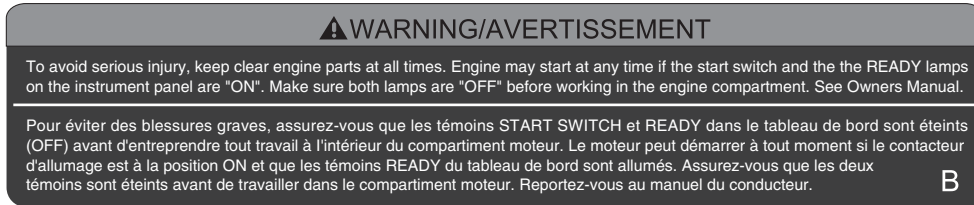

AAYIA0419ZZ

The following warning label is applied to the high-voltage battery located inside the luggage compartment near the service plug access opening.



AAYIA0455ZZ

The following warning label is applied to the high-voltage battery located inside the luggage compartment.



AAYIA0456ZZ

2-5 High-voltage Safety System

The high-voltage safety system is intended to help keep vehicle occupants and emergency responders safe from high-voltage electricity.

- A high-voltage fuse provides short circuit protection inside the high-voltage battery.
- The high-voltage safety system is insulated from the metal chassis.
- Positive and negative high-voltage power cables are connected to the high-voltage battery and are controlled by normally open system main relays (SMR1 and SMR2). When the vehicle is shut off, the relays stop electrical flow from leaving the high-voltage battery. However, it can take approximately ten (10) minutes for the high-voltage capacitor to fully discharge.

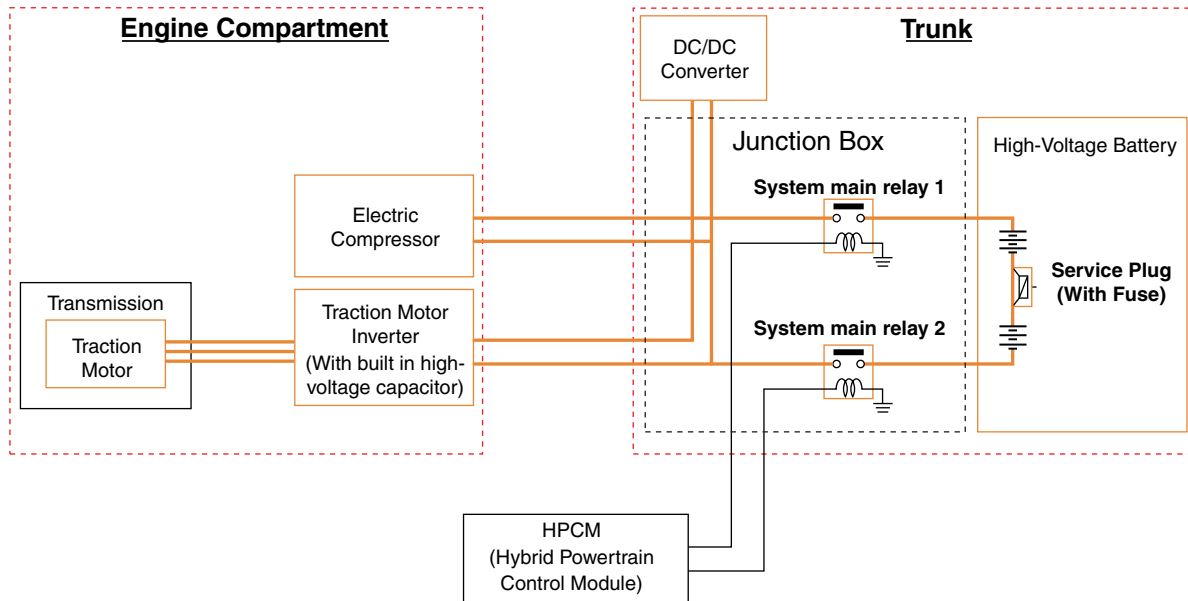

AAYIA0156GB

⚠ WARNING

- **The high-voltage system and high-voltage capacitor may remain powered for up to approximately 10 minutes after the vehicle is shut off. Personal Protective Equipment (PPE) must always be worn when touching or working on high-voltage components to avoid risk of electrical shock and severe personal injury or death.**
 - **The high-voltage battery retains high-voltage at all times. PPE must always be worn when touching or working on high-voltage components to avoid risk of electrical shock and severe personal injury or death.**
-
- A ground fault monitor continuously monitors for high-voltage leakage to the metal chassis while the vehicle is running. If a malfunction is detected, the HPCM (hybrid powertrain control module) will illuminate the hybrid system warning lamp  in the instrument cluster.
 - The high-voltage battery relays (SMR1 and SMR2) will automatically open to stop the electrical flow in front, side or certain rear collisions that are sufficient enough to activate the supplemental restraint system (SRS).

2-6 High-voltage Circuit Shut-Off System

This vehicle is equipped with a system to shut off the current from the high-voltage battery by the following methods:

Service plug	Positioned in the center area of the high-voltage battery, this plug shuts off the output of high-voltage when manually removed.
System main relays (located in the high-voltage battery)	Controlled by the ignition switch, these relays are powered by the 12-volt system and shut off high-voltage from the high-voltage battery.
Emergency shut-off system	In the case of a collision (front and side collisions in which the air bags are deployed, certain rear collisions) or certain system malfunctions this system is designed to shut off the high-voltage from the high-voltage battery.

2-7 Preventing Electrical Shock

1. If it is necessary to touch any of the high-voltage harnesses or components, always wear appropriate Personal Protective Equipment (PPE) (refer to [3-1 Preparation Items \(FRG-17\)](#)). Shut off the high-voltage system by referring to [3-3.1 High-voltage System Shut-Down Procedure \(FRG-21\)](#).
2. To avoid the risk of electrocution, NEVER touch the inside of the high-voltage battery with bare hands after shutting off the high-voltage system. The high-voltage battery maintains charge even though the high-voltage system is shut down. PPE must always be worn when touching or working on high-voltage components.
3. Cover damaged high-voltage components with insulated tape.

2-8 Emergency Medical Equipment

The high-voltage system should not interfere with emergency medical equipment which must be used in or near the vehicle at an accident scene.

3. Emergency Response Steps







DANGER



- Failure to properly shut down the high-voltage electrical system before the Emergency Response Procedures are performed will result in serious injury or death from electrical shock. To prevent serious injury or death, **NEVER** touch high-voltage harnesses or components without always wearing appropriate Personal Protective Equipment (PPE). PPE must always be worn when touching or working on high-voltage components.
- If it is necessary to touch any of the high-voltage harnesses or components you must always wear appropriate PPE to avoid electrical shock. PPE must always be worn when touching or working on high-voltage components. Shut down the high-voltage system by following the steps outlined in [3-3.1 High-voltage System Shut-Down Procedure \(FRG-21\)](#) Wait approximately ten (10) minutes for complete discharge of the high-voltage capacitor after the high-voltage system has been shut down.

WARNING

- NEVER** assume the Q50 HYBRID is shut OFF simply because it is quiet.
- If the **READY** indicator is ON the high-voltage system is active.
- If possible, be sure to check the **READY** indicator on the instrument cluster and verify that the **READY** indicator is OFF and the high-voltage system is stopped.

3-1 Preparation Items

Preparation Items	Specification	Purpose
PPE (personal protective equipment): Insulated gloves 	Up to 1,000V	For protection from high-voltage electrical shock.
Insulated shoes 	-	
Safety shield 	-	To protect eyes when around high-voltage components and wiring.
Safety Glasses 		

Preparation Items	Specification	Purpose
Leather gloves 	Must be able to fasten tight around the wrist. (Worn over insulated gloves)	To protect insulated gloves.
Wrenches 	Size:10mm	To remove the 12-volt battery terminal bolt.
Solvent resistant protection gloves Solvent resistant protection shoes	–	To utilize in the event of a high-voltage battery electrolytic solution leak.
Absorbent pad	The same pad used for internal combustion engine fluids can be used.	To absorb any high-voltage battery electrolytic solution leakage.
Standard fire fighting equipment	Standard fire fighting equipment. Depending on type of fire (vehicle or battery) use standard fire fighting equipment (water or extinguisher).	To extinguish a fire.
Insulated tape	Insulating	To cover any damaged harnesses to protect from and prevent electrical shock. Tape should cover all bare or damaged wire.

3-1.1 Personal Protective Equipment (PPE) Protective Wear Control

Perform an inspection of the Personal Protective Equipment (PPE) items before beginning work. Do not use any damaged PPE items.

3-1.2 Daily Inspection

This inspection is performed before and after use. The responder who will be using the items should perform the inspection and check for deterioration and damage.

- Insulated rubber gloves should be inspected for scratches, holes and tears. (Visual check and air leakage test)
- Insulated safety boots should be inspected for holes, damage, nails, metal pieces, wear or other problems on the soles. (Visual check)
- Insulated rubber sheet should be inspected for tears. (Visual check)

3-1.3 Insulated Tools

When performing work at locations where high-voltage is applied (such as terminals), use insulated tools meeting 1,000V/300A specifications.

3-2 Vehicle Immobilization and Stabilization

If possible, immobilize the vehicle by turning the 12-volt system OFF and stabilize it with a wheel chock(s). Stabilize the vehicle with cribbing, by removing air from the tires, or utilize the Lift Airbag Equipment for rescue.

⚠ WARNING

⚠ To avoid electrical shock, do not put the Lift Airbag Equipment for rescue and wheel chock(s) under the high-voltage components and harnesses.

 =  **⚠ DANGER**

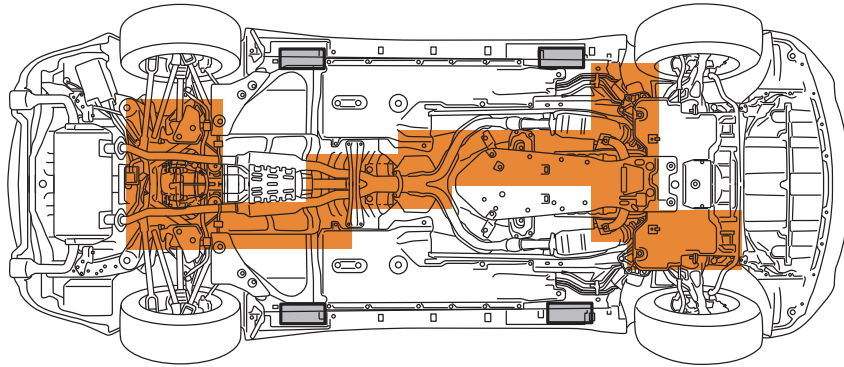
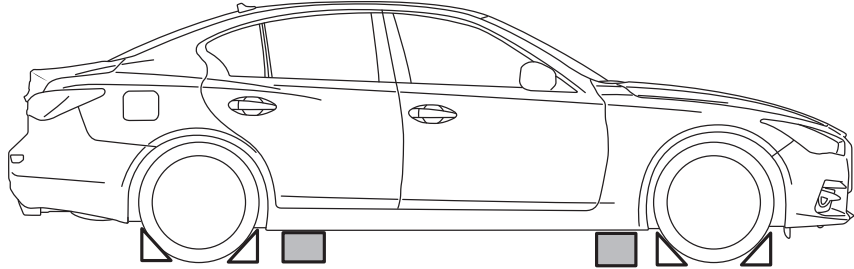

AAYIA0185ZZ

3-3 How to Handle a Damaged Vehicle at an Accident Scene

NOTE:

If any air bags have deployed in the following 3 situations, the high-voltage (HV) system has been designed to automatically shut off at the time of deployment.

The Infiniti Q50 HYBRID high-voltage system incorporates capacitors which are energized whenever the high-voltage system is on. If the high-voltage system is shut down (either through one of the built-in automatic mechanisms or manually through one of the procedures explained in this FRG), the capacitors will begin to gradually discharge. **Complete discharge requires approximately 10 minutes after high-voltage system shut down.** It is within this period of time that responders must be most cautious.

When arriving to an incident involving an Infiniti Q50 HYBRID, the vehicle should be approached with caution and inspected for the level of damage. In addition to overall vehicle condition (location and severity of body damage, air bag deployment, etc.), the high-voltage system should be assessed specifically. The locations of the high-voltage component parts are illustrated in this FRG. Refer to [2-2 High-voltage-Related and 12-Volt-Related Component Locations and Descriptions \(FRG-11\)](#). Appropriate personal protective equipment (PPE) must always be worn when approaching a vehicle of unknown condition, as described in this FRG.

Situation 1) High-voltage system intact, occupants can be accessed without extrication tools

The HV system can be shut down by following the procedure in this guide, while wearing appropriate PPE. After HV system shut down, occupant assistance can begin immediately, and no wait period is necessary.

Situation 2) High-voltage system intact, occupants cannot be accessed without extrication tools

The HV system can be shut down by following the procedure in this guide, while wearing appropriate PPE. After HV system shut down, absolute care must be taken never to cut through or damage any HV system wiring, battery or components **within approximately ten (10) minutes of HV system shut down**, but occupant assistance operations using extrication equipment can begin immediately. The locations of the HV components are illustrated in this guide.

Situation 3) High-voltage (HV) system damaged

If there is any evidence that the HV system has been compromised (such as arcing/sparking, orange wiring harnesses cut or damaged, HV component casings damaged, etc.), the responder may still be at risk of high-voltage exposure. The vehicle must be approached with extreme caution prior to initiating any system shut down procedures or rendering assistance to occupants. Appropriate PPE must always be worn as described in this guide, and the **approximate ten (10) minute wait time must be observed after HV system shut down** in order to ensure the system is de-energized.

In rare situations where vehicle damage is very severe, HV system shut down procedures as described in this guide may not work. In these instances extreme caution and appropriate risk management must be followed to prevent shock or electrocution to the responder or occupant.

3-3.1 High-voltage System Shut-Down Procedure

Any of the following procedures can shut down the high-voltage system. The first response operation should only begin after shutting down the high-voltage system. If the vehicle is heavily damaged, for example the high-voltage battery is deformed, broken or cracked, appropriate PPE must always be used and the high-voltage battery and high-voltage components must not be touched. PPE must always be worn when touching or working on high-voltage components.



DANGER

- **Failure to properly shut down the high-voltage system before the Emergency Response Procedures are performed will result in serious injury or death from electrical shock. To prevent serious injury or death, NEVER touch high-voltage harnesses or components without always wearing appropriate Personal Protective Equipment (PPE). Appropriate PPE must always be worn when touching or working on high-voltage components.**
- **When contact with high-voltage components or high-voltage harnesses is unavoidable, or when there is risk of such contact, you must always wear appropriate PPE. PPE must always be worn when touching or working on high-voltage components.**

WARNING

- **The vehicle contains parts that contain powerful magnets. If a person who is wearing a pacemaker or other medical device is close to these parts, the medical device may be affected by the magnets. Such persons must not perform work on the vehicle.**
- **Be sure to verify that the READY indicator is off (if possible), and the high-voltage system is stopped.**
- **After the high-voltage system is shut down, please wait approximately ten (10) minutes for complete discharge of the high-voltage capacitor. While waiting, do not operate any vehicle functions.**

NOTE:

The high-voltage full discharge takes approximately ten (10) minutes.

- **After shutting down the high-voltage system and removing the 12-volt battery negative (-) terminal, wait at least three (3) minutes to discharge the air bag capacitor. Even though the 12-volt battery negative (-) is disconnected, the Supplemental Restraint System (SRS) air bag maintains voltage at least three (3) minutes. During this time, there is a possibility of sudden SRS air bag inflation due to harness short circuit or damage and it may cause serious injuries.**
- **The 12V system will remain active even after the 12-volt battery negative (-) terminal is removed while the high-voltage system is active. This is because the charging system will not shut down and power will be supplied to the 12V system and high-voltage system continuously.**

Before disconnecting the 12-volt battery terminal, if necessary, lower the windows, adjust the steering column, adjust the seats, unlock the doors, open the trunk, etc. as required. Once the 12-volt battery is disconnected, power controls will not operate.

Powering Down the High-voltage System

The high-voltage system can be shut down with any 1 of the following procedures:

- Turn OFF the power switch and disconnect the 12-volt battery. Refer to [Primary Procedure \(FRG-22\)](#).
- Disconnect the underhood fuse panel terminal connector for the high-voltage control system and disconnect the 12-volt battery. Refer to [Alternate Procedure 1 \(Disconnect Underhood Fuse Panel\) \(FRG-25\)](#).
- Remove the service plug and disconnect the 12-volt battery. Refer to [Alternate Procedure 2 \(Remove Service Plug\) \(FRG-28\)](#).

Primary Procedure

NOTE:

Before disconnecting the 12-volt battery terminal, if necessary, lower the windows, adjust the steering column, adjust the seats, unlock the doors, etc. Once 12-volt battery is disconnected, power controls will not operate.

1. If possible, check the READY  indicator status in the instrument cluster. If it is on, the high-voltage system is active.
2. Place the shift selector in the Park (P) position.

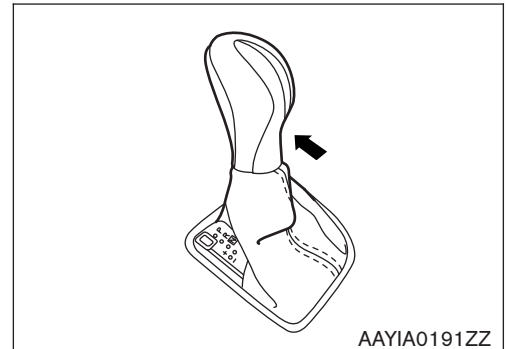

3. Push the ignition switch once to turn OFF the high-voltage system. Verify that the READY indicator is off and then continue to the next steps to open the trunk for 12-volt battery negative cable access.

If the READY indicator does not turn off, refer to [Alternate Procedure 1 \(Disconnect Underhood Fuse Panel\) \(FRG-25\)](#)

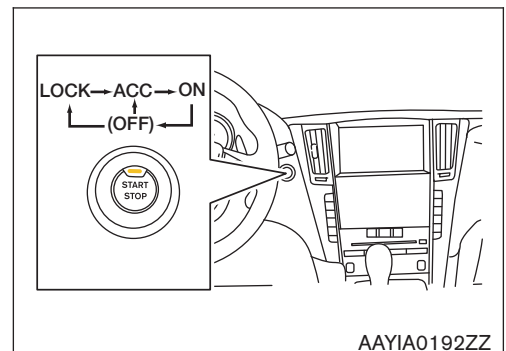

4. If possible, keep the Infiniti Intelligent Key at least 5 meters (16 feet) away from the vehicle (except to open the trunk as noted below).

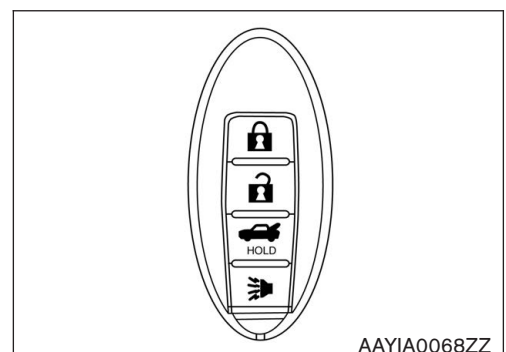

5. Open the trunk using any of the following:

NOTE:

The trunk release power cancel switch must be in the ON position in order for the trunk to be opened using any of the methods below.

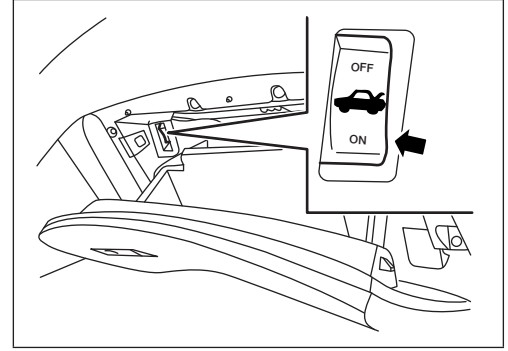

- a. push-button switch on the lower LH side of the instrument panel (ensure that the trunk release power cancel switch is in the ON position).

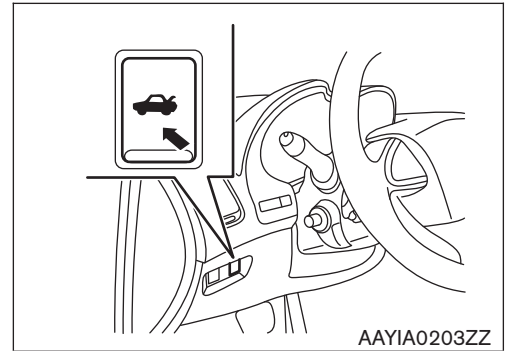

- b. trunk button on the Infiniti Intelligent Key [press for longer than one (1) second].

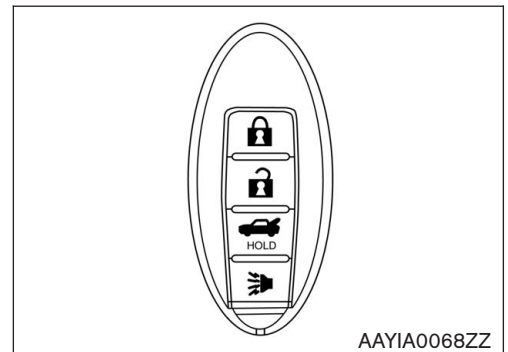

- c. trunk open request switch (located above license plate)*.

* You must have the Infiniti Intelligent Key within approximately 1 meter (3 feet) range of trunk request switch to use the trunk open request switch function.

NOTE:

If the electrical release does not work, the trunk will have to be forced open.

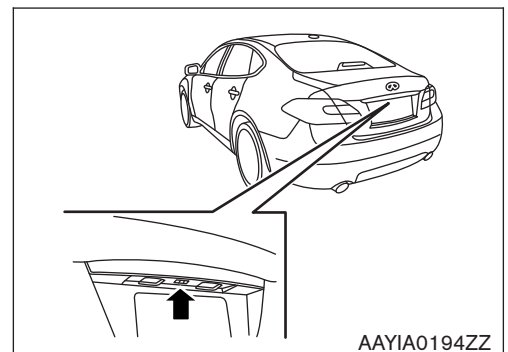

6. Open the 12-volt battery service access cover.

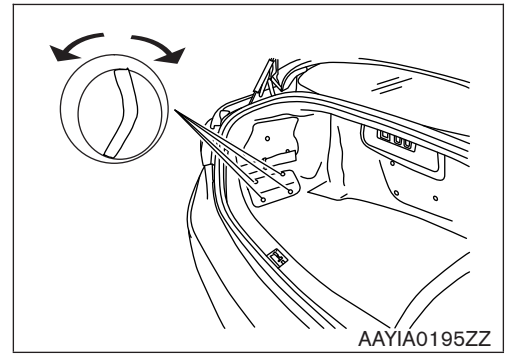

7. Disconnect negative (-) battery cable and cover it with insulated tape.

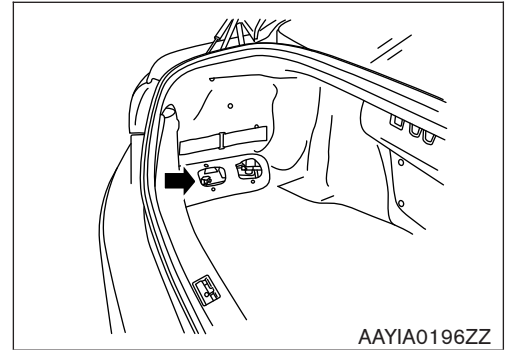

8. **Wait approximately ten (10) minutes for complete discharge** of the high-voltage capacitor after the battery cable has been disconnected.
9. Perform the first response action.

Alternate Procedure 1 (Disconnect Underhood Fuse Panel)

NOTE:

Before disconnecting the underhood fuse panel and the negative (-) battery cable, if necessary, lower the windows, adjust the steering column, adjust the seats, unlock the doors, etc. Once the underhood fuse panel and negative (-) battery cable are disconnected, power controls will not operate.

1. Pull release handle (1) and pull up release lever (2) to open the hood.

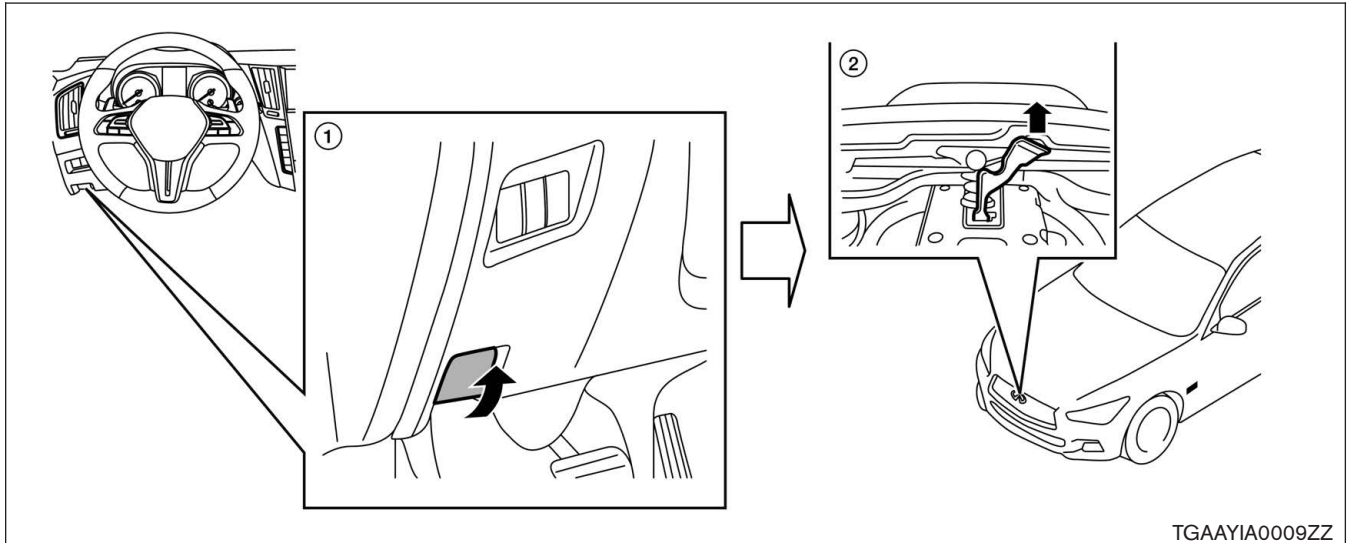

2. Remove clips (A) and RH hood ledge cover (1).

NOTE:

← : Arrow in illustration depicts vehicle front direction.

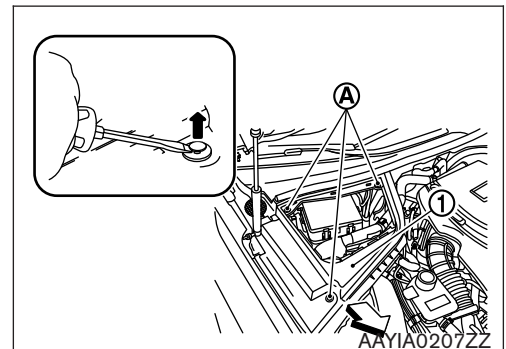

3. Remove clips (A) and RH cowl cover (1).

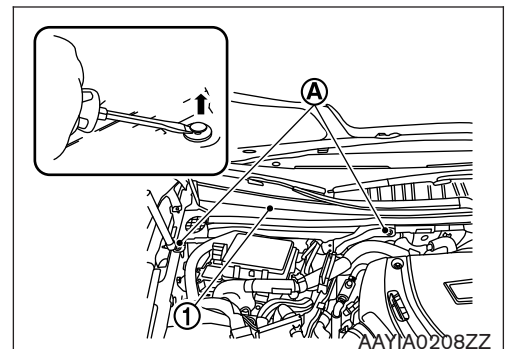

4. Disengage pawls (A) of underhood fuse panel cover and remove underhood fuse panel cover (1).

NOTE:

← : Arrow in illustration depicts vehicle front direction.

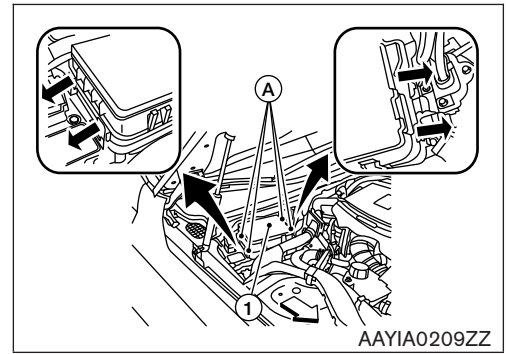

5. Pull underhood fuse panel (1) out by hand and disconnect terminal (black) connector (A).

NOTE:

← : Arrow in illustration depicts vehicle front direction.

6. If you cannot identify the connector, disconnect all connectors on the underhood fuse panel.

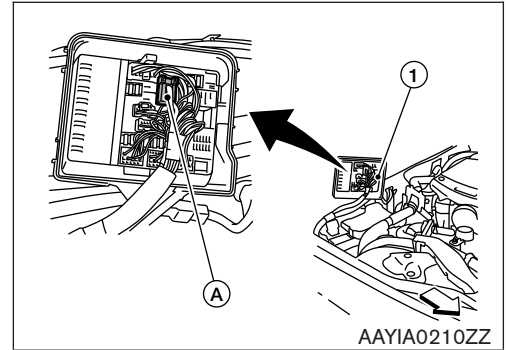

⚠ WARNING

To avoid unintended reinstallation and risk of electrical shock and severe personal injury or death, the rescuer should cover the fuse box and connectors with insulated tape or remove the fuse panel and carry on his/her person.

7. Open the trunk using any of the following:

NOTE:

The trunk release power cancel switch must be in the ON position in order for the trunk to be opened using any of the methods below.

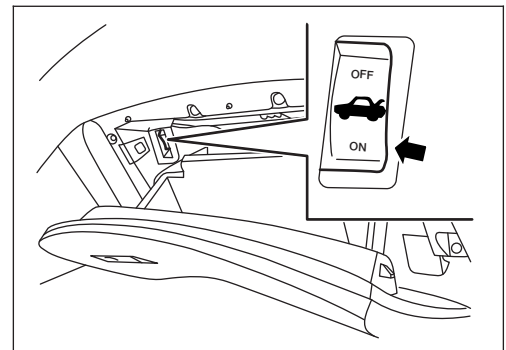

- a. push-button switch on the lower LH side of the instrument panel (ensure that the trunk release power cancel switch is in the ON position).

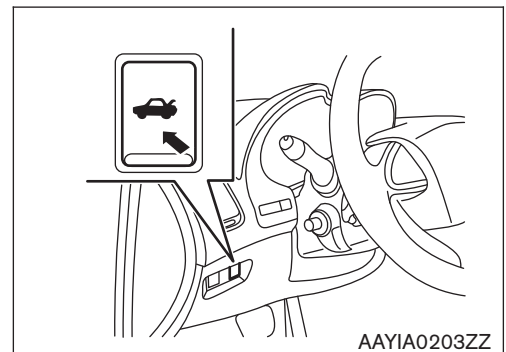

- b. trunk button on the Infiniti Intelligent Key [press for longer than one (1) second].

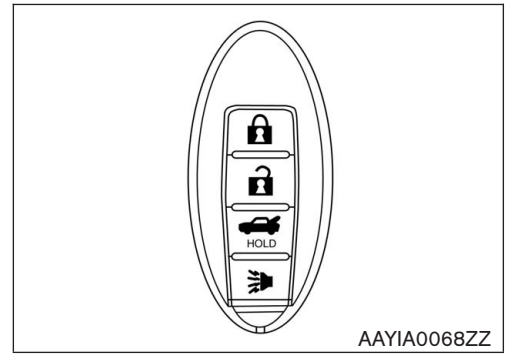

- c. trunk open request switch (located above license plate)*.

* You must have the Infiniti Intelligent Key within approximately 1 meter (3 feet) range of trunk request switch to use the trunk open request switch function.

NOTE:
If the electrical release does not work, the trunk will have to be forced open.

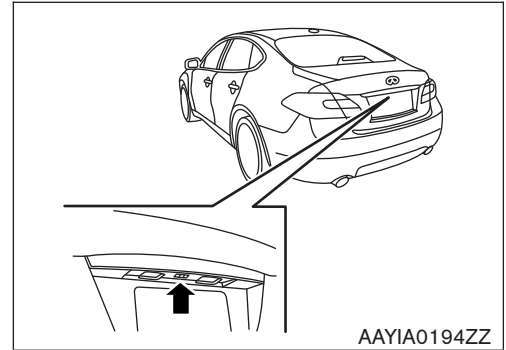

8. Open the 12-volt battery service access cover.

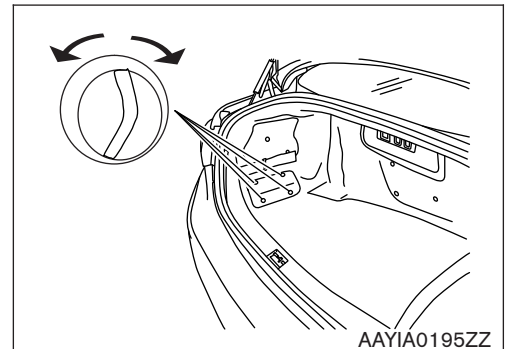

9. Disconnect negative (-) battery cable and cover it with insulated tape.

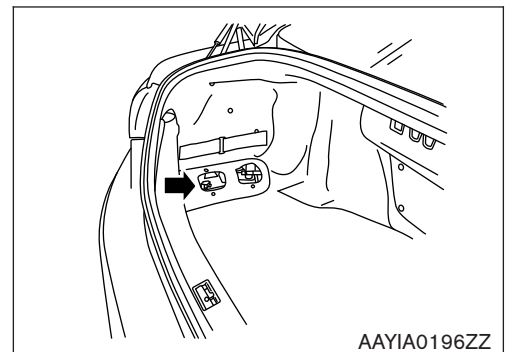



10. **Wait approximately ten (10) minutes for complete discharge** of the high-voltage capacitor after the fuse panel and battery cable have been disconnected.
11. Perform the first response action.

Alternate Procedure 2 (Remove Service Plug)



DANGER

-  **Do not remove the service plug without always wearing appropriate Personal Protective Equipment (PPE) to help protect the responder from serious injury or death by electrical shock.**
-  **Immediately cover the service plug socket with insulated tape. The high-voltage battery retains high-voltage power even when the service plug is removed. To avoid electric shock, NEVER touch the terminals inside the socket.**

WARNING



To avoid unintended reinstallation and risk of electrical shock and severe personal injury or death, the rescuer should carry the service plug on his/her person while work is in progress.

NOTE:

Before disconnecting the 12-volt battery terminal, if necessary, lower the windows, adjust the steering column, adjust the seats, unlock the doors, etc. Once 12-volt battery is disconnected, power controls will not operate.

1. If possible, check the READY  indicator status in the instrument cluster. If it is on, the high-voltage system is active.
2. Place the shift selector in the Park (P) position.

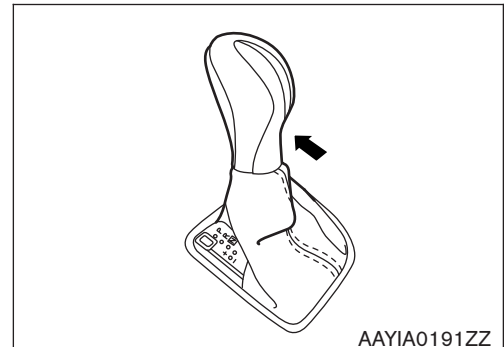

3. Push the ignition switch once to turn OFF the high-voltage system. Then verify whether the READY indicator is off.

If the READY indicator does not turn off, continue to step 4.

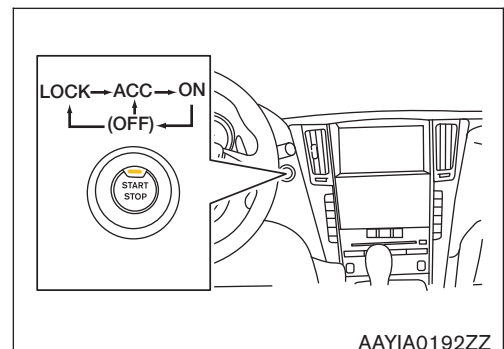

4. If possible, keep the Infiniti Intelligent Key at least 5 meters (16 feet) away from the vehicle (except to open the trunk as noted below).

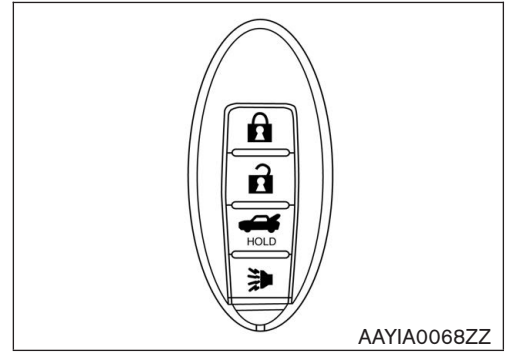

5. Open the trunk using any of the following:

NOTE:

The trunk release power cancel switch must be in the ON position in order for the trunk to be opened using any of the methods below.

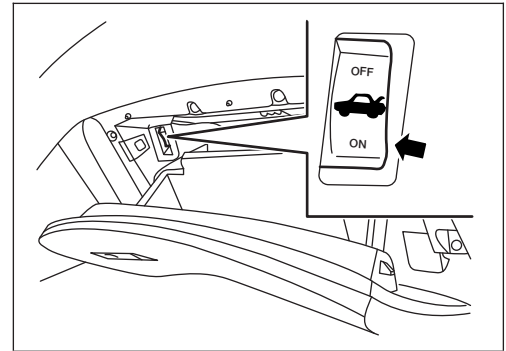

- a. push-button switch on the lower LH side of the instrument panel.

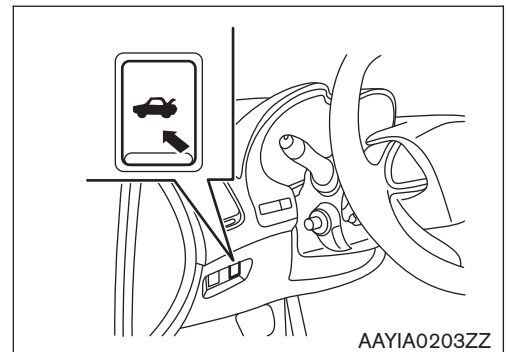

- b. trunk button on the Infiniti Intelligent Key [press for longer than one (1) second].

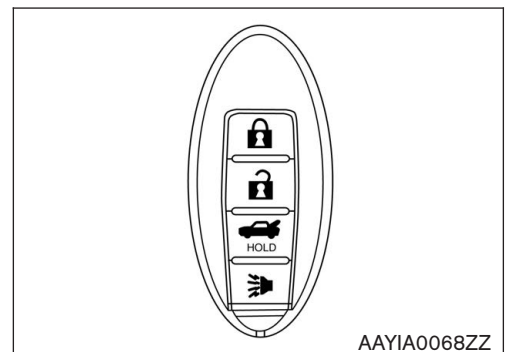

- c. trunk open request switch (located above license plate)*.

* You must have the Infiniti Intelligent Key within approximately 1 meter (3 feet) range of trunk request switch to use the trunk open request switch function.

NOTE:

If the electrical release does not work, the trunk will have to be forced open.

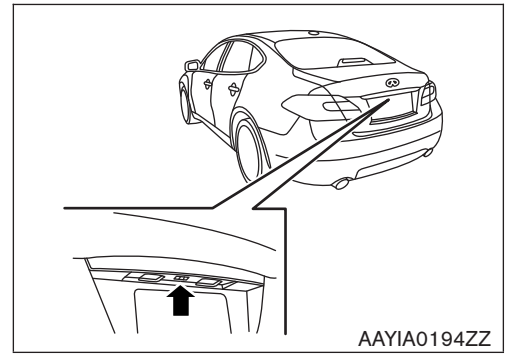

6. Open the 12-volt battery service access cover.

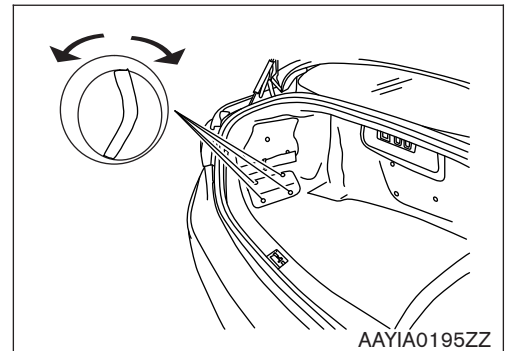

7. Disconnect negative (-) battery cable and cover it with insulated tape.

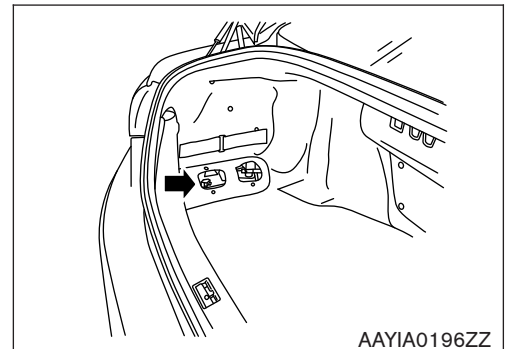

8. Open service plug access cover.

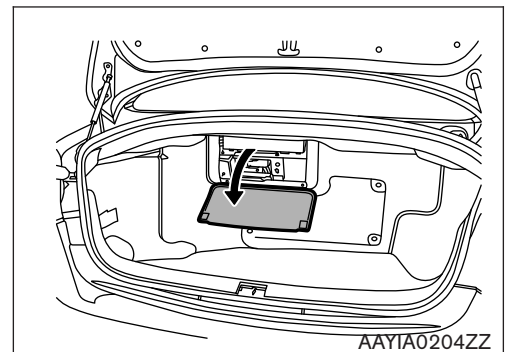

9. Remove the service plug (A) by pulling the locking lever (B), then pressing the locking tab (C) and rotating the handle (D) fully outward. Using the handle, pull the service plug (E) completely out of its socket.

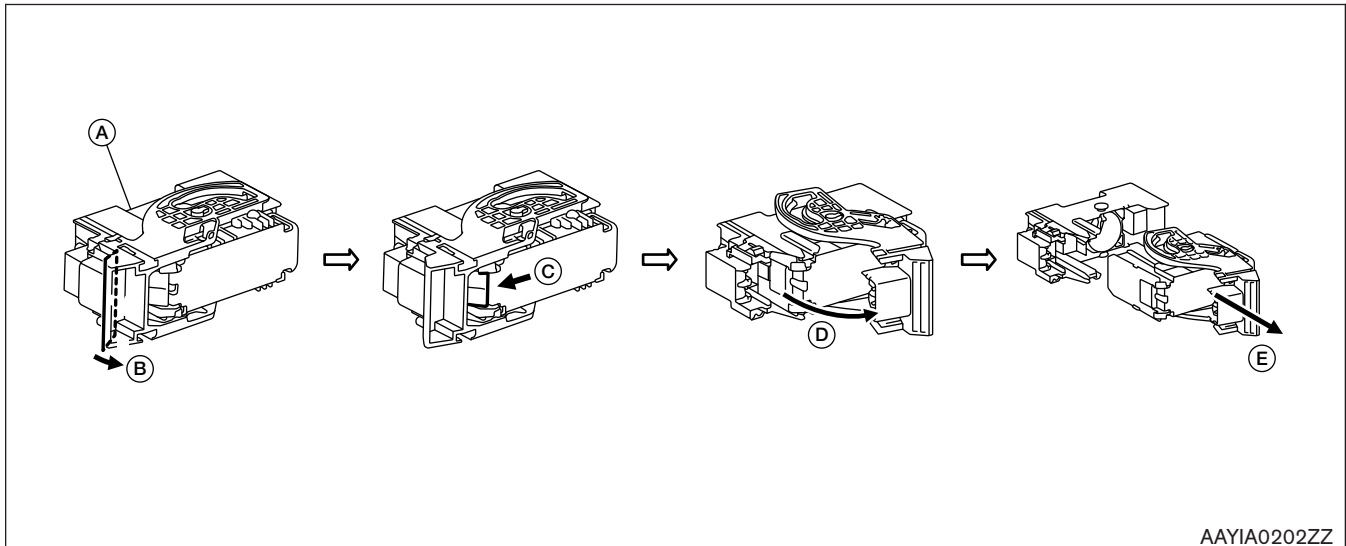

10. **Wait approximately ten (10) minutes for complete discharge** of the high-voltage capacitor after the service plug has been removed.
11. Perform the first response action.

3-3.2 Water Submersion





DANGER



Damage level of submerged vehicle may not be apparent. Handling a submerged vehicle without appropriate Personal Protective Equipment (PPE) will result in serious injury or death from electrical shock.

WARNING

-  **The ignition switch of the submerged vehicle must be turned OFF first, if possible. Then the vehicle must be completely out of the water and drained to avoid electrical shock.**
-  **Always wear appropriate Personal Protective Equipment (PPE) and remove/drain water before removing the service plug when working on a vehicle after a fire or submersion to avoid electrical shock.**
-  **If the vehicle is in the water, to avoid electrical shock NEVER touch the high-voltage components, harnesses or service plug. PPE must always be worn when touching or working on high-voltage components.**

3-3.3 Vehicle Fire

⚠ WARNING

- Always utilize full Personal Protective Equipment (PPE) and self-contained breathing apparatus during fire fighting operations. Smoke from a Q50 HYBRID vehicle fire is similar to smoke from a conventional vehicle fire.
- In the case of extinguishing a fire with water, large amounts of water from a fire hydrant (if possible) must be used. DO NOT extinguish fire with a small amount of water.

⚠ CAUTION

In the event of a small fire, a Type ABC fire extinguisher may be used for an electrical fire caused by wiring harnesses, electrical components, etc. or oil fire.

Fire attack should follow standard fire fighting practices.



If you must walk away from the vehicle, notify an appropriate responder or a rescue person of the fact that the vehicle is a hybrid vehicle and contains a high-voltage system and warn all others.

During overhaul operations (late stage fire suppression process to examine for remaining sources of heat), make sure the battery is fully cooled to avoid fire re-ignition. The battery could reignite if it is placed near fire. To avoid possible electrical shock and serious personal injury, do not breach the high-voltage battery case.

3-3.4 Cutting the Vehicle Body



⚠ DANGER

-  Do not cut into high-voltage related areas to avoid severe personal injury or death.
-  Do not cut into the high-voltage battery to avoid severe personal injury or death.
-  When removing parts, NEVER touch the high-voltage parts or the insides of the exposed orange-colored high-voltage cables to avoid severe personal injury or death. Appropriate Personal Protective Equipment (PPE) must always be worn when touching or working on high-voltage components.

⚠ WARNING

Do not cut air bag parts to avoid unintended deployment of the air bags and the risk of severe personal injury or death.

If **at least approximately ten (10) minutes** have passed since the rescuer shut down the high-voltage system (refer to [3-3.1 High-voltage System Shut-Down Procedure \(FRG-21\)](#)), then the rescuer can cut the vehicle except for the high-voltage battery.

If the rescuer cannot wait approximately ten (10) minutes or shut down the high-voltage system, absolute care must be taken to avoid cutting HV parts and appropriate Personal Protective Equipment (PPE) must always be worn. DO NOT cut the high-voltage battery due to possible electrocution risk and electrolyte solution leakage.

SRS Air Bag System Components Location

Avoid cutting air bag system parts. However, the vehicle can be cut (except inflators) under the following conditions:

- The front, side and curtain air bags have deployed.
- At least three (3) minutes have passed after the 12-volt battery negative (-) cable has been disconnected and the high-voltage system has been shut down.

 = Inflators
(Peel back plastic trim parts prior to cutting operation to confirm exact inflator location.)

 = Sensors

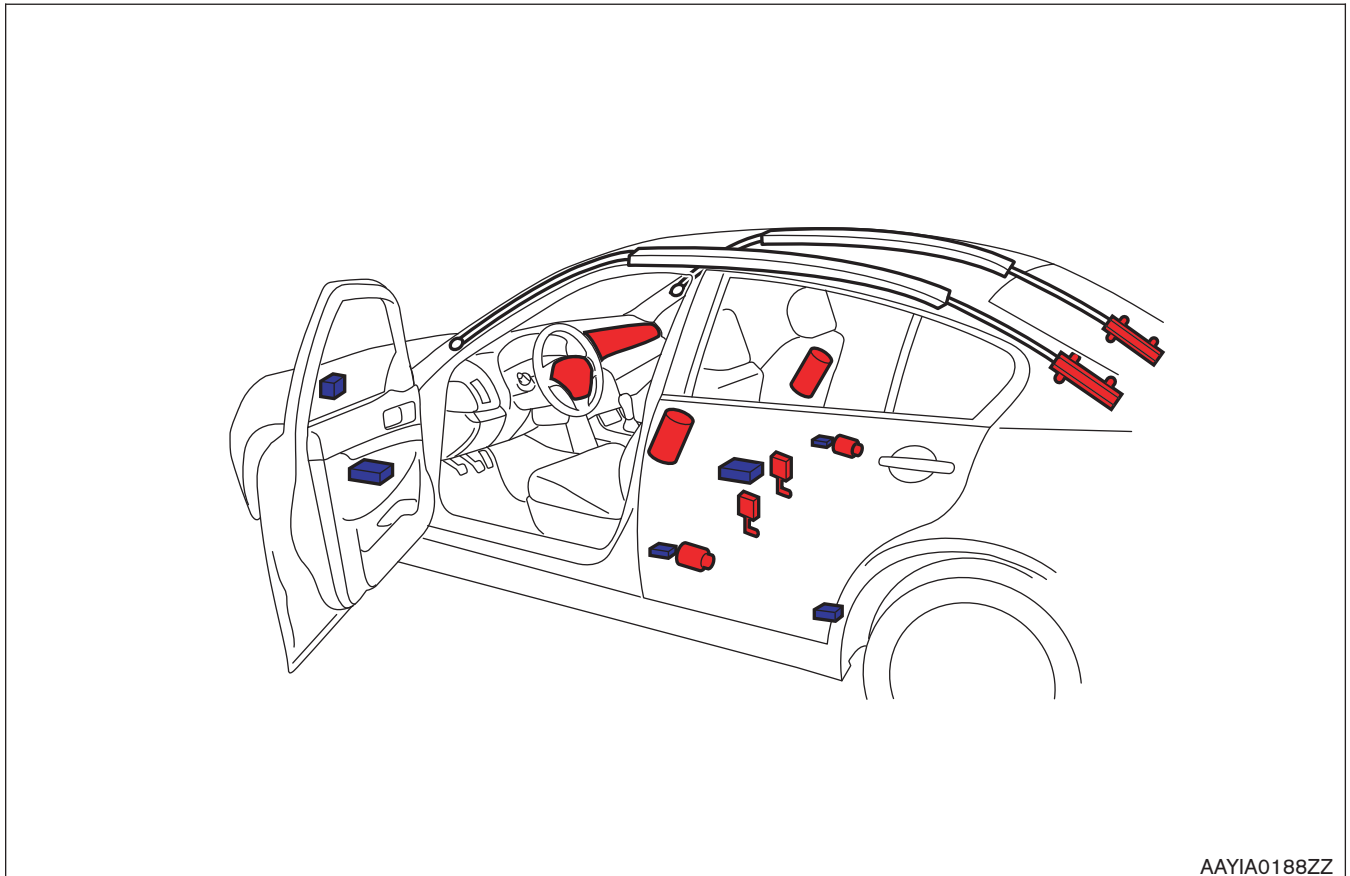

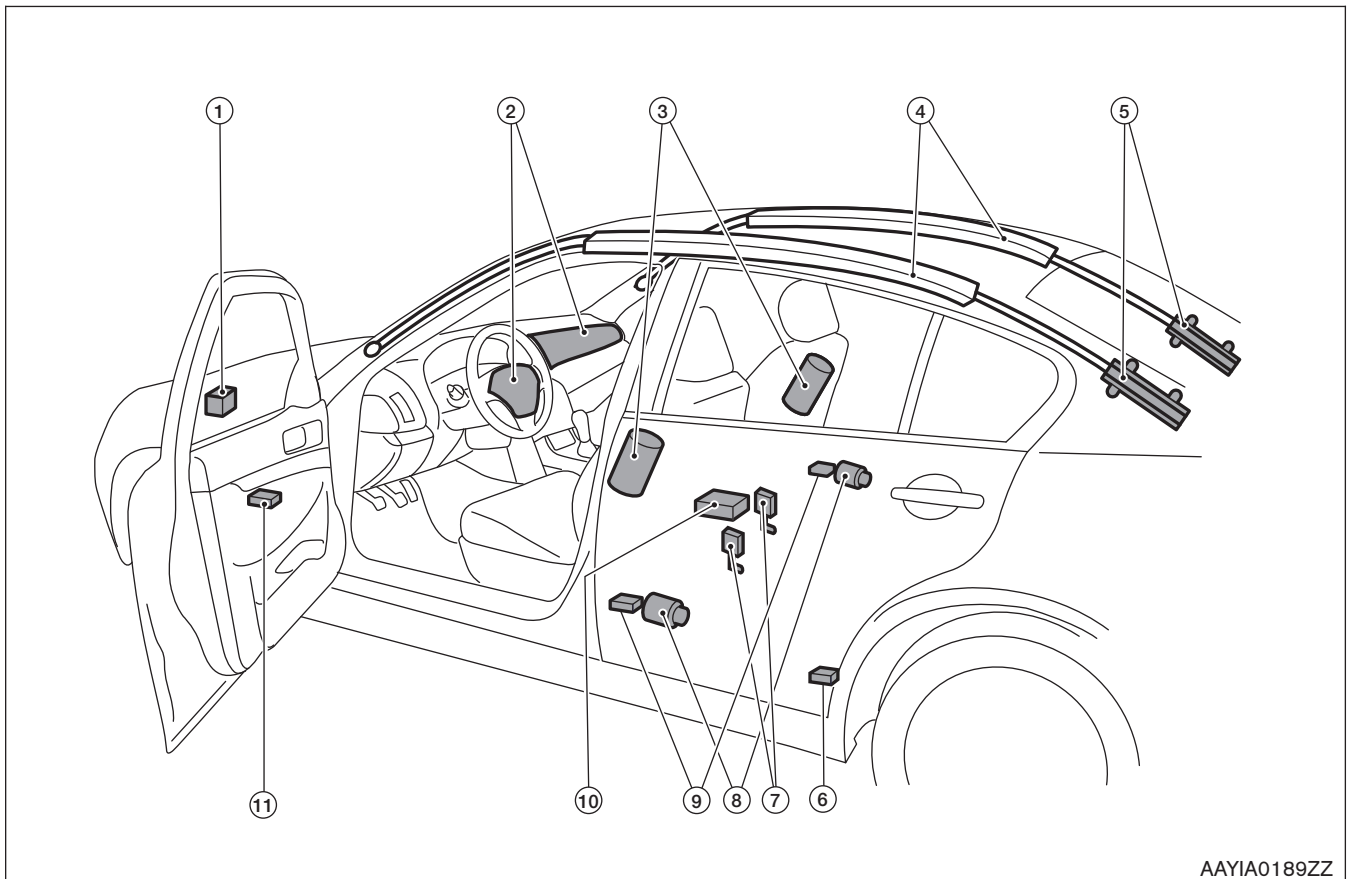

AAYIA0189ZZ

1. Crash zone sensor (located underhood near hood latch)

2. Supplemental front air bag modules (Infiniti Advanced Air Bags)

3. Front seat-mounted side-impact supplemental air bags

4. Roof-mounted curtain side-impact supplemental air bags

5. Roof-mounted curtain side-impact supplemental air bag inflators

6. C-pillar satellite sensors (LH shown, RH similar)

7. Seat belt buckle pretensioners

8. Seat belts with pretensioners

9. B-pillar satellite sensors

10. Air bag control unit (ACU)

11. Front door satellite sensors (LH shown, RH similar)

Infiniti Emergency Contact
 1-800-662-6200 (US) or 1-800-361-4792 (Canada)
 Hours of Operation: 8am-5pm (Monday-Friday) Eastern,
 Central and Pacific Time Zones

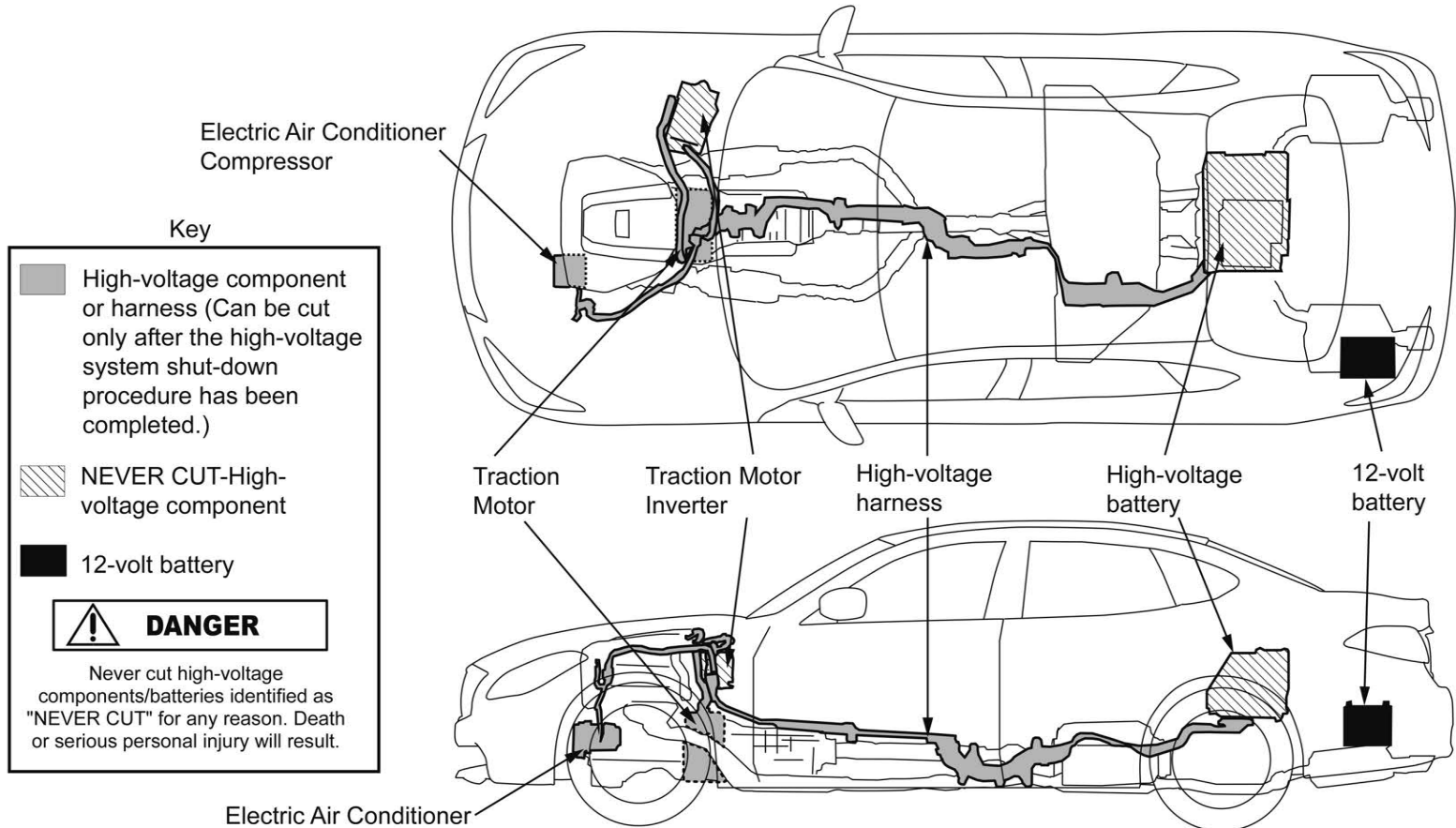

Electric Air Conditioner Compressor
 Nissan North America, Inc. Version (3)

June 2017

TGAAYIA0002GB

High Strength Steel Locations

 = High strength steel

 =  

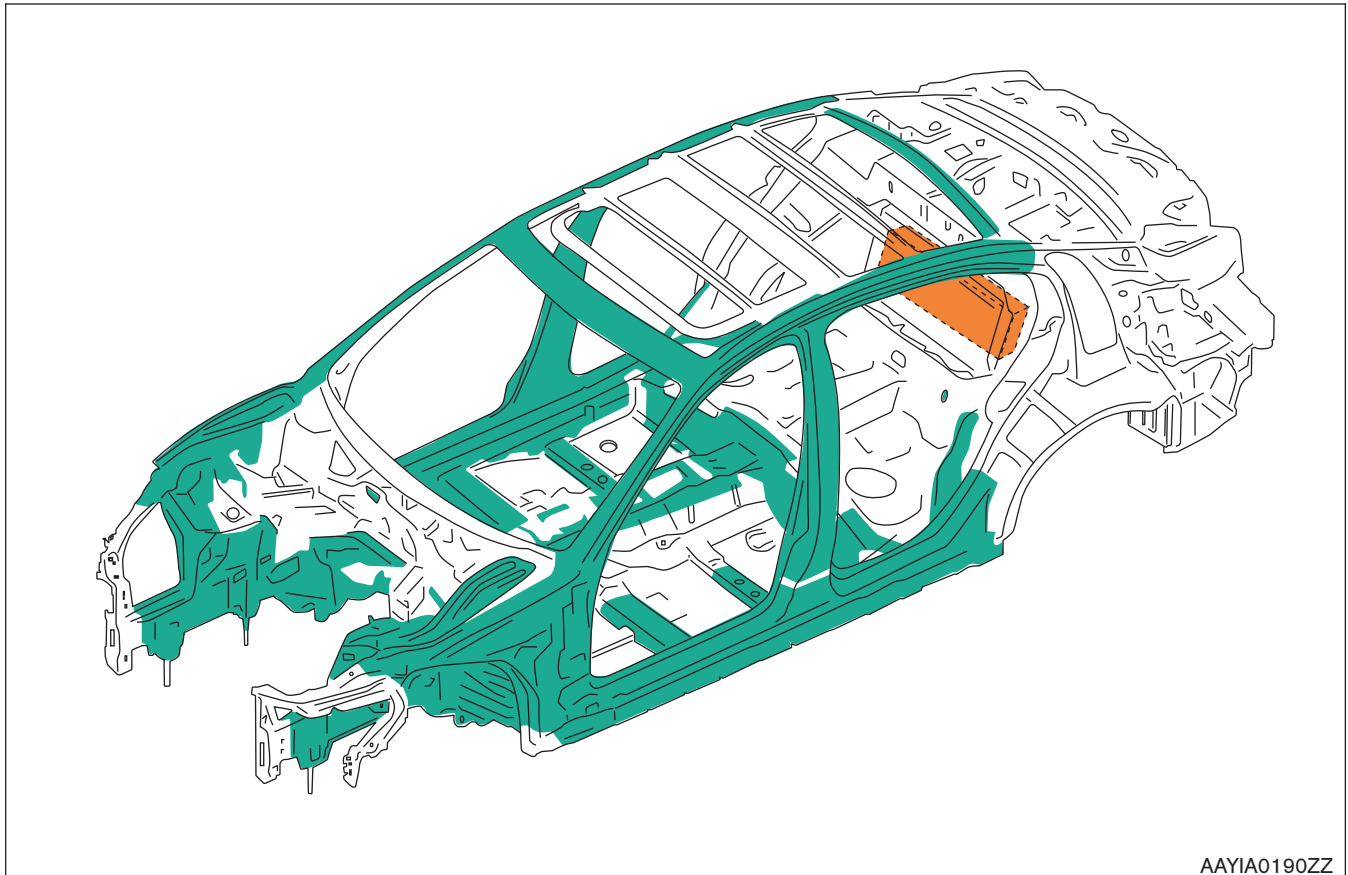

AAYIA0190ZZ

3-3.5 High-voltage Battery Damage And Fluid Leaks

WARNING

The high-voltage battery contains electrolyte solution. To avoid exposure to electrolyte solution and serious personal injury, always wear appropriate solvent resistant Personal Protective Equipment (PPE) and read the following precautions:

- Electrolyte solution is a skin irritant.
- Electrolyte solution is an eye irritant – If contact with eyes, rinse with plenty of water and see a doctor immediately.
- If electrolyte leak occurs, wear appropriate solvent resistant PPE and use a dry cloth to clean up the spilled electrolyte. Be sure to adequately ventilate the area.
- Electrolyte solution is highly flammable.
- Electrolyte liquid or fumes that have come into contact with water vapors in the air will create an oxidized substance. This substance may irritate skin and eyes. In these cases, rinse with plenty of water and see a doctor immediately.
- Electrolyte fumes (when inhaled) can cause respiratory irritation and acute intoxication. Move to fresh air and wash mouth with water. See a doctor immediately.

If electrolyte solution leakage, or damage such as any problem with the high-voltage battery casing are observed, first responders should attempt to neutralize the battery by applying a large volume of water to the battery pack while wearing appropriate Personal Protective Equipment (PPE). The neutralization process helps stabilize the thermal condition of the battery pack but does not discharge the battery.

High-voltage Battery Electrolyte Solution Characteristics:

- Clear in color
- Sweet odor
- Similar viscosity to water
- Since the high-voltage battery is made up of many small sealed battery modules, electrolyte solution leakage should be minimal.

NOTE:

Other fluids in the vehicle (such as engine oil, washer fluid, brake fluid, coolant, etc.) are the same as those in a conventional vehicle.

3-3.6 Accessing the Occupants

1. Remove windows
 - a. Perform window removal the same as a normal vehicle.
2. Remove doors
 - a. The doors are removable with hand tools or basic rescue tools such as electrical/hydraulic rescue tools. It may be easier to remove the doors by cutting door hinges.

NOTE:

Before disconnecting the 12-volt battery terminal, if necessary, lower the windows, adjust the steering column, adjust the seats, unlock the doors, etc. Once 12-volt battery is disconnected, power controls will not operate.

3. Adjust steering wheel and front seat position (if necessary) as shown below:

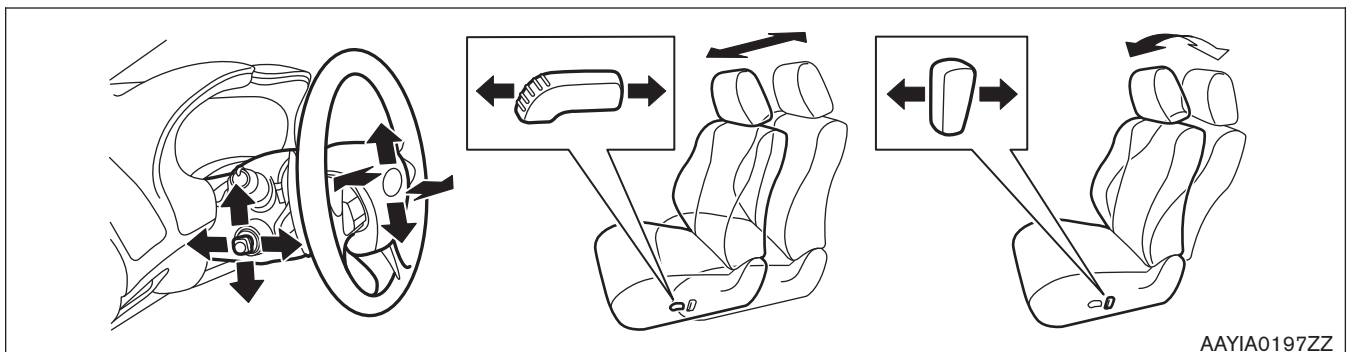

4. Remove front seat head restraint (if necessary).

The front seat head restraint can be removed by pressing the lock knob and pulling it up.

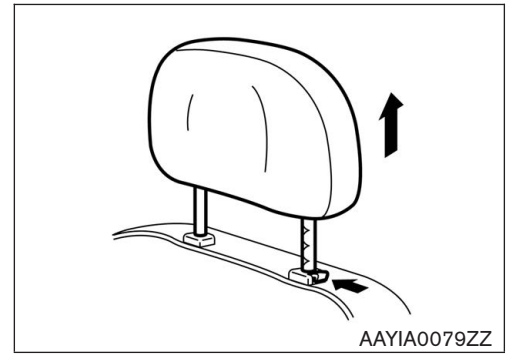

5. Unfasten the seat belt.

Seat belt can be unfastened by pressing the release button. If seat belt cannot be unfastened, cut it with a belt cutter.

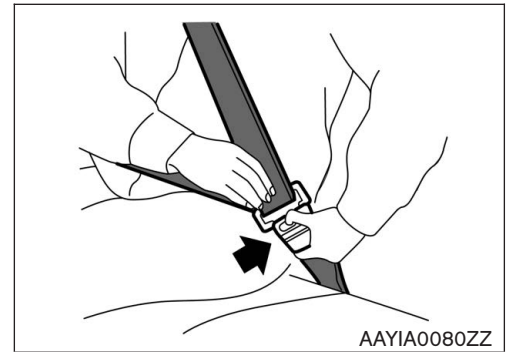

3-4 Storing The Vehicle

For vehicle storage information, refer to Dismantling Guide located at www.infiniti.com or www.infiniti-techinfo.com.

4. Emergency Quick Reference Guide

The following is for emergency quick reference only. It does not replace the detailed safety information and procedures in this manual.

2018 INFINITI Q50 HYBRID

Emergency Responder's Quick Reference Guide

The following is for emergency quick reference only. It does not replace the detailed safety information and procedures in the First Responder's Guide (FRG).

VEHICLE IDENTIFICATION



HYBRID



HYBRID

WARNING AND INDICATOR LAMPS

LAMP NAME	ICON	DESCRIPTION
READY Indicator (GREEN)		This lamp is on when the high-voltage system is powered up and the vehicle is ready to drive.
Master Warning Lamp (ORANGE or RED)		This lamp is on when another warning lamp or message is displayed in the instrument cluster.
Hybrid System Warning Lamp (ORANGE)		<p>This lamp is on when:</p> <ul style="list-style-type: none"> ▪ Malfunction has occurred in the hybrid control system and/or ▪ High-voltage leak to vehicle chassis and/or ▪ Emergency shut-off system has been activated. The shut-off system activates in the following conditions: <ul style="list-style-type: none"> – Front and side collisions in which the air bags are deployed. – Certain rear collisions. – Certain high-voltage system malfunctions.

HIGH-VOLTAGE (HV) PARTS LOCATIONS

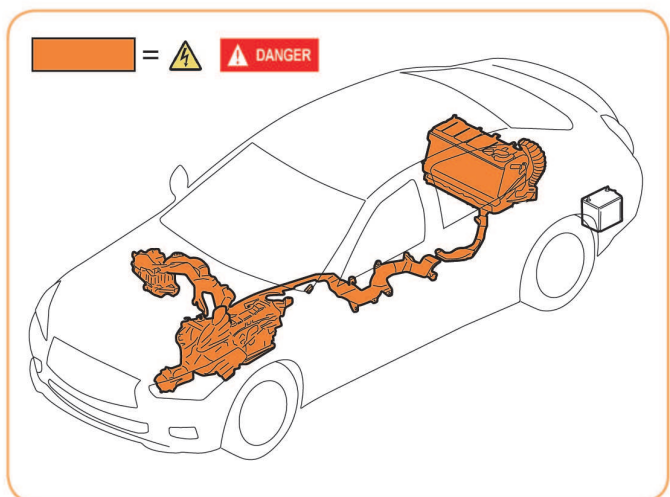

DO NOT CUT HV PARTS!

2018 INFINITI Q50 HYBRID

Emergency Responder's Quick Reference Guide

The following is for emergency quick reference only. It does not replace the detailed safety information and procedures in the First Responder's Guide (FRG).

VEHICLE SHUT-DOWN

Appropriate Personal Protective Equipment (PPE) must always be worn during these procedures and while working on or near high-voltage components, battery or harnesses!

PRIMARY PROCEDURE

1. Turn Power Switch OFF.



2. Verify READY indicator is OFF.

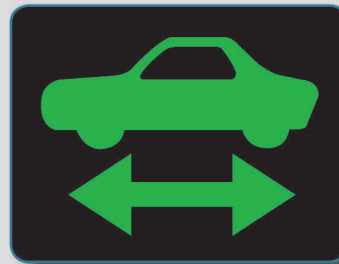

3. If possible, keep the Intelligent Key at least 5 meters (16 feet) away.



4. Open Trunk and Remove Negative Battery Cable.



ALTERNATE PROCEDURE 1.

1. Disconnect connector

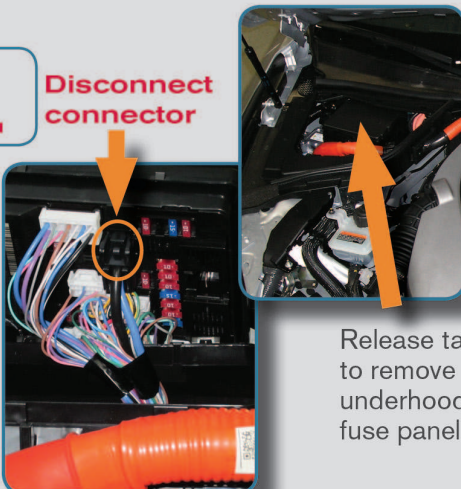

Release tabs to remove underhood fuse panel.

2. Open Trunk and Remove Negative Battery Cable.



2018 INFINITI Q50 HYBRID

Emergency Responder's Quick Reference Guide

The following is for emergency quick reference only. It does not replace the detailed safety information and procedures in the First Responder's Guide (FRG).

ALTERNATE PROCEDURE 2.

1.

Open Trunk and Remove Negative Battery Cable.



2.

Remove Service Plug.

Located behind access cover in trunk.

- 1 Pull service plug lever.
- 2 Release lever locking tab.
- 3 Rotate green lever outward.
- 4 Pull to remove

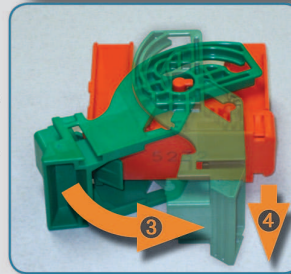
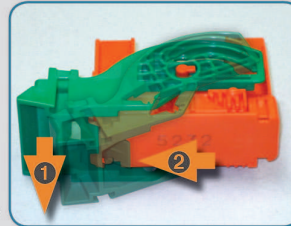

- 5 Wait approximately 10 minutes for the HV system to fully discharge. If unable to wait full 10 minutes, absolute care must be taken and full Personal Protective Equipment (PPE) must be worn.

HIGH-VOLTAGE SYSTEM SHUT DOWN AND VEHICLE DAMAGE LEVEL CONSIDERATIONS

Note: If any air bags have deployed in the following 3 situations, the high-voltage (HV) system has been designed to automatically shut off at the time of deployment.

1) High-voltage (HV) system intact, occupants can be accessed without extrication tools

The HV system can be shut down by following the procedure in this QRG, while wearing appropriate Personal Protective Equipment (PPE). After HV system shut down, occupant assistance operations can begin immediately, and no wait period is necessary.

(2) High-voltage (HV) system intact, occupants cannot be accessed without extrication tools

The HV system can be shut down by following the procedure in this QRG, while wearing appropriate Personal Protective Equipment (PPE). After HV system shut down, absolute care must be taken never to cut through or damage any HV system wiring, battery or components within approximately 10 minutes of HV system shut down, but occupant assistance operations using extrication equipment can begin immediately. The locations of the HV component parts are illustrated in this QRG.

(3) High-voltage (HV) system damaged

If there is any evidence that the HV system has been compromised (such as arcing/sparking, orange wiring harnesses cut or damaged, HV component casings damaged, etc.), the responder may still be at risk of high-voltage exposure. The vehicle must be approached with extreme caution prior to initiating any system shut down procedures or rendering assistance to occupants. Appropriate Personal Protective Equipment (PPE) must always be worn as described in the FRG, and the approximate 10 minute wait time must be observed after HV system shut down in order to ensure the system is de-energized.

In rare situations where vehicle damage is very severe, HV system shut down procedures as described in the FRG or this QRG may not work. In these instances extreme caution and appropriate risk management must be followed to prevent shock or electrocution to the responder or occupant.

2018 INFINITI Q50 HYBRID

Emergency Responder's Quick Reference Guide

The following is for emergency quick reference only. It does not replace the detailed safety information and procedures in the First Responder's Guide (FRG).

VEHICLE IDENTIFICATION

SRS AIR BAG SYSTEM PARTS LOCATIONS

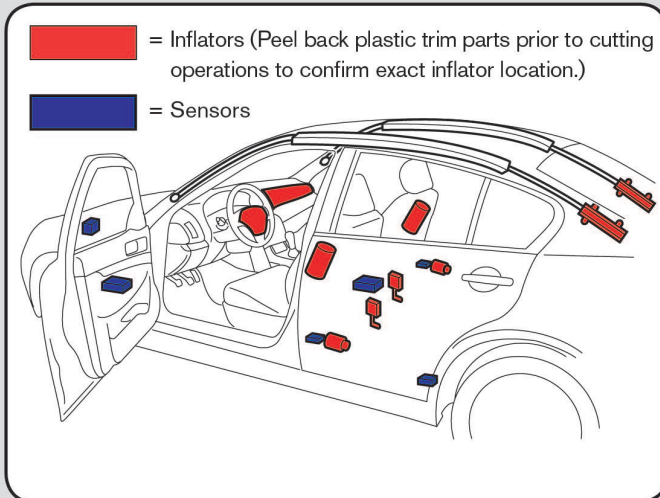

DO NOT CUT AIR BAG PARTS!

VEHICLE FIRE

- Use standard firefighting equipment.
- Use large amounts of water.
- Be sure high-voltage battery is completely extinguished and cooled to avoid reignition.

VEHICLE SUBMERSION

- Wear appropriate Personal Protective Equipment (PPE) before entering water.
- Vehicle must be removed from water and drained before touching any HV parts.

HIGH-VOLTAGE BATTERY ELECTROLYTE CHARACTERISTICS

- Clear in color.
- Sweet odor.
- Similar viscosity to water.
- Highly flammable.
- Skin and eye irritant – rinse with plenty of water and see a doctor immediately.
- Wear appropriate Personal Protective Equipment (PPE) around electrolyte leakage.

HIGH STRENGTH STEEL LOCATIONS

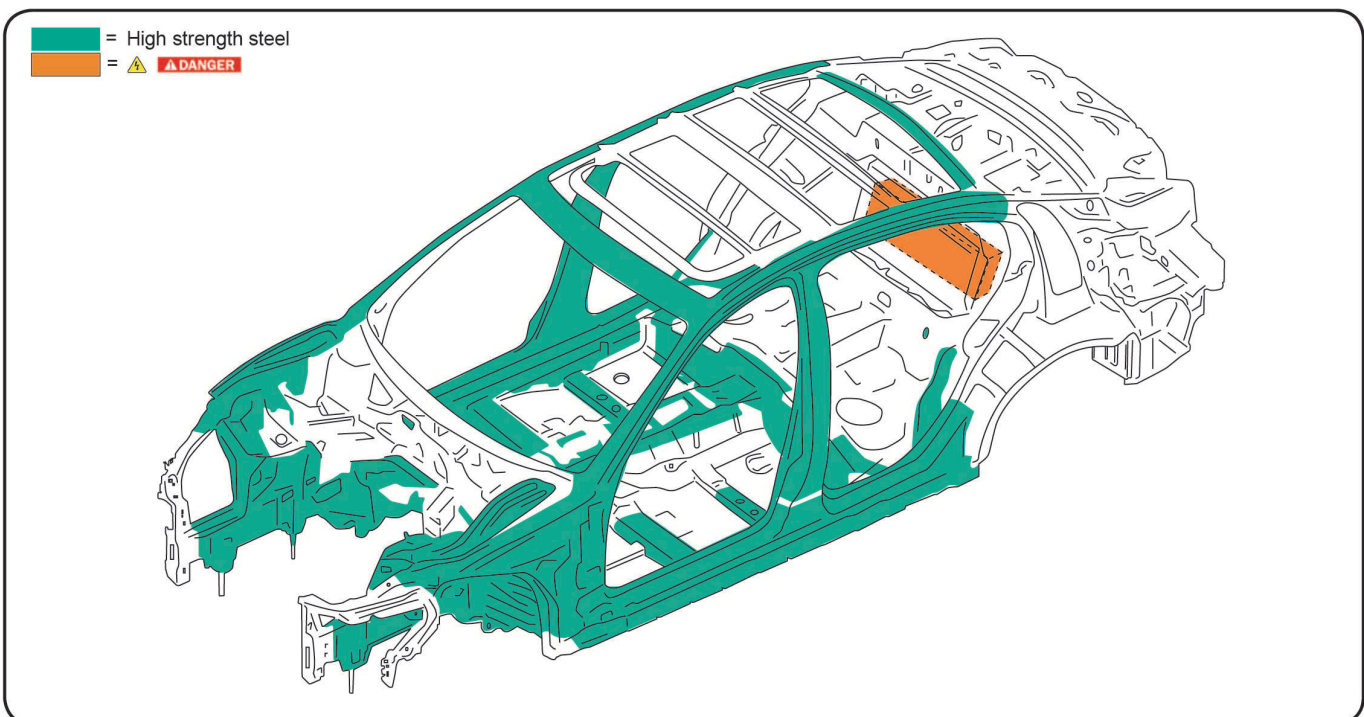



I N F I N I T I .[®]

© 2017 Nissan North America, Inc.

All rights reserved.

This document may not be altered without the written permission of Nissan North America, Inc.

Pub. No. FR18EAV37HU0