



**RESCUE GUIDELINE FOR PLUG-IN HYBRID VEHICLE  
MINI COOPER S E COUNTRYMAN ALL4.**



# EDITORIAL.

The MINI Cooper S E Countryman ALL4 combines an electric motor with an internal combustion engine. The energy required by the electric motor is supplied by a high-voltage battery. This rescue guideline will help prepare you, as an emergency crew, for recovering the MINI plug-in hybrid vehicle.

This guideline is based on a standardised format developed at the behest of emergency crews.

” Working with many experts, we have also developed two documents which are to be used for training and as a guide for how to proceed at the scene of an accident: the rescue manual and rescue sheet! “

BMW has made both documents available for download free of charge at the following website:  
<https://aos.bmwgroup.com/service/rescue-info>

” The VDA answers frequently asked questions. “

You can download the current version of the FAQ at the following address:  
<https://www.vda.de/en/services/Publications/rescue-and-towing-of-vehicles-with-high-voltage-systems.html>

# CONTENTS.

The standardised format of the rescue guideline ensures that you have quick access to the information you require across all brands and series.

1	Identification/recognition.	6
2	Immobilisation/stabilisation/lifting.	14
3	Disable direct hazards/safety regulations.	20
4	Access to the occupants.	28
5	Stored energy/liquids/gases/solids.	34
6	Fire.	42
7	Submersion in water.	46
8	Towing/transportation/storage.	50
9	References.	58

# 1. IDENTIFICATION/ RECOGNITION



# EXTERIOR IDENTIFYING FEATURES.

A variety of features distinguish the MINI Cooper S E Countryman ALL4 from the conventional MINI Countryman. You can generally identify the plug-in hybrid vehicle by the yellow 'S' and a yellow connector symbol (the 'E' badge). A detailed look at the identifying features:



'E' badge (connector symbol) on the engine cover.



Charging socket cover on the left front panel with 'E' badge.



Fresh air grille with yellow 'S'.



'E' badge on the left-hand side of the tailgate.



Door sill cover strips with 'MINI Cooper S' inscription and yellow 'S'.

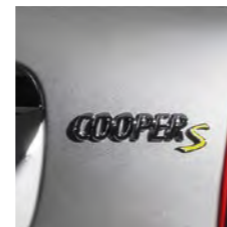

Model designation 'Cooper S' with yellow 'S' on the right-hand side of the tailgate.

# INTERIOR IDENTIFYING FEATURES.

Important elements in the interior also appear in yellow. A detailed look at the features:



Central information display with hybrid-specific features.



Instrument cluster with hybrid-specific features.



Refuelling button.

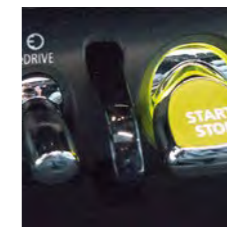

eDRIVE toggle on the left next to the start/stop toggle.



High-voltage disconnect.

# IDENTIFICATION OF THE HIGH-VOLTAGE COMPONENTS.

The high-voltage system is intrinsically safe and will typically switch off automatically in the event of an accident, eliminating electrical hazard. The system components are connected via orange high-voltage cables, making them recognisable at first glance.



High-voltage cables can be identified by the orange-coloured insulation or coating.

An overview of high-voltage components.

- ① Electric A/C compressor.
- ② High-voltage starter motor generator.
- ③ Electrical heating.
- ④ Charging socket.
- ⑤ High-voltage battery unit.
- ⑥ Electrical machine.
- ⑦ Electrical machine electronics.
- ⑧ Convenience charging electronics.

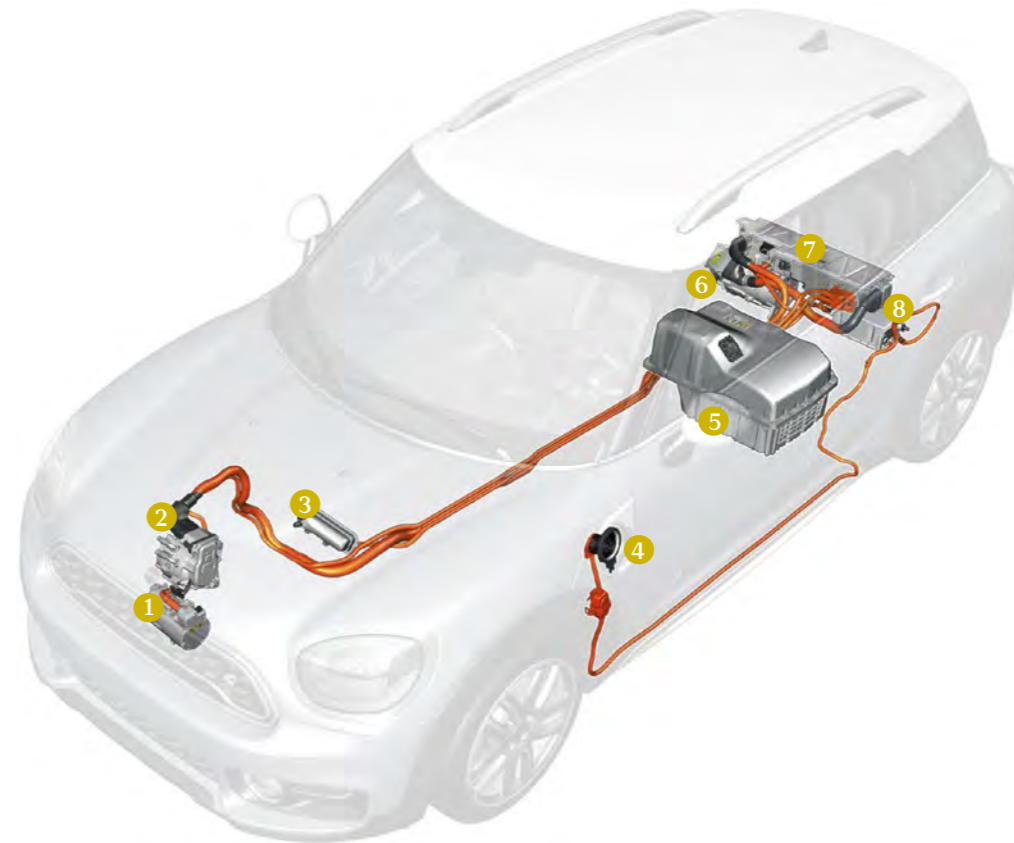

# THE HIGH-VOLTAGE BATTERY.

The high-voltage battery provides the electric motor and other components such as the starter generator and the air-conditioning compressor with the energy they require, and is positioned in a space that protects it from external influences, thus increasing the safety of the occupants and the emergency crews.

The high-voltage battery unit consists of five modules arranged in two layers. Each module consists of, among other things, 16 lithium-ion cells with a voltage of 3.66 V and a capacity of 26 Ah, thus achieving a total voltage of 293 V. The amount of energy that can be stored is 7.6 kWh.



## HINT.

The housing of each high-voltage component features a warning that intuitively indicates possible dangers through electrical potential.



# 2. IMMOBILISATION/ STABILISATION/ LIFTING.





# SWITCHING OFF THE VEHICLE.

As with conventional vehicles, you also have to switch off the MINI plug-in hybrid vehicle and prevent it from rolling away. Due to the new concept of operation, you may find some switches in unfamiliar places.

## The general rule is:

If airbags deploy during the accident, the high-voltage system will typically deactivate automatically, meaning it's discharged.



**DOES A PARKED VEHICLE WHICH HAS BEEN INVOLVED IN AN ACCIDENT (STATIONARY CRASH) POSE AN ELECTRICAL HAZARD?**

- Airbags will not usually deploy when parked high-voltage vehicles are involved in a 'stationary crash', meaning the high-voltage system will not be switched off automatically.

If this is the case, please proceed as follows described by VDA:

- Pull on the high-voltage disconnect (Service Disconnect) (see chapter 3 for more detail).
- The de-energised state will then be displayed in the instrument cluster.
- Press the START/STOP button to turn off the ignition.
- Also, disconnect the negative terminal of the 12-volt battery in the engine compartment.



## HINT.

Immediate display of the de-energised state after an accident may not be possible due to a whole host of potential damage scenarios. In case of doubt, the vehicle's high-voltage system needs to be deactivated manually at the high-voltage disconnect if possible.

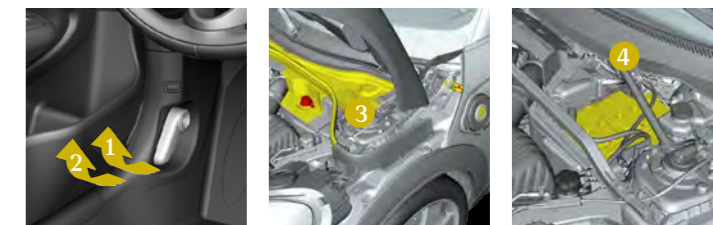

Open the bonnet  
1. Pull the lever, arrow **1**.  
The bonnet will be unlocked.  
2. Release the lever and then pull it again, arrow **2**.  
The bonnet can be opened.

Then remove the battery cover **3**.

Disconnect the negative terminal **4** on the yellow 12-volt battery.

## SECURING VEHICLE FROM ROLLING AWAY.

To prevent the MINI from rolling away, pull the switch for the electric parking brake all the way up. You can also secure the vehicle, for example, with wheel chocks.

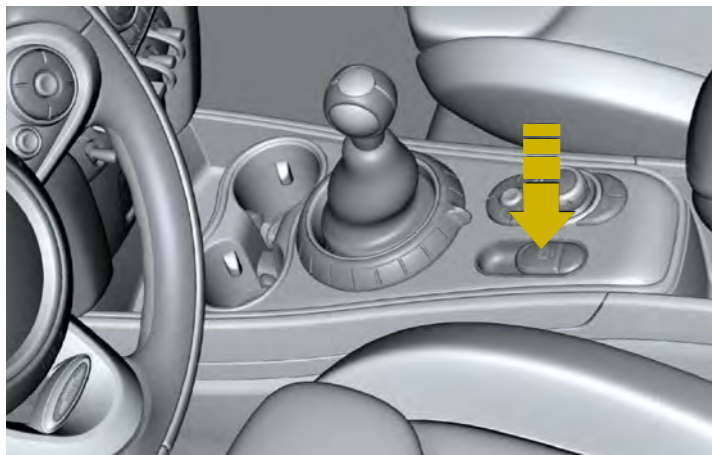

## LIFTING THE VEHICLE.

If you need to lift the vehicle, please be aware of the corresponding mounting points for the jack.

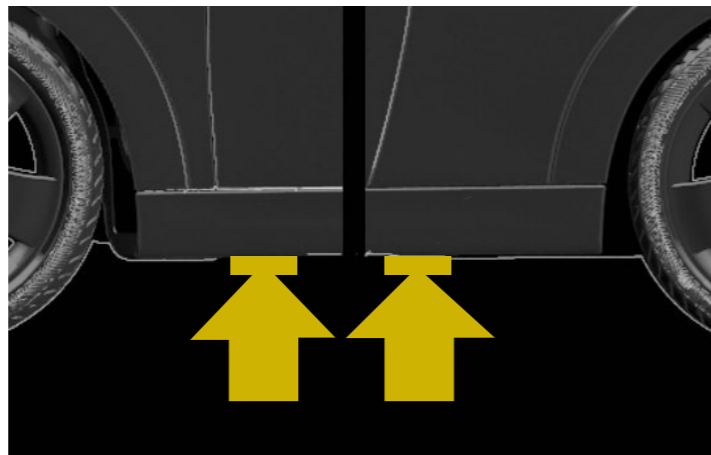

There are also zones in the underbody where load-bearing devices should not be used:

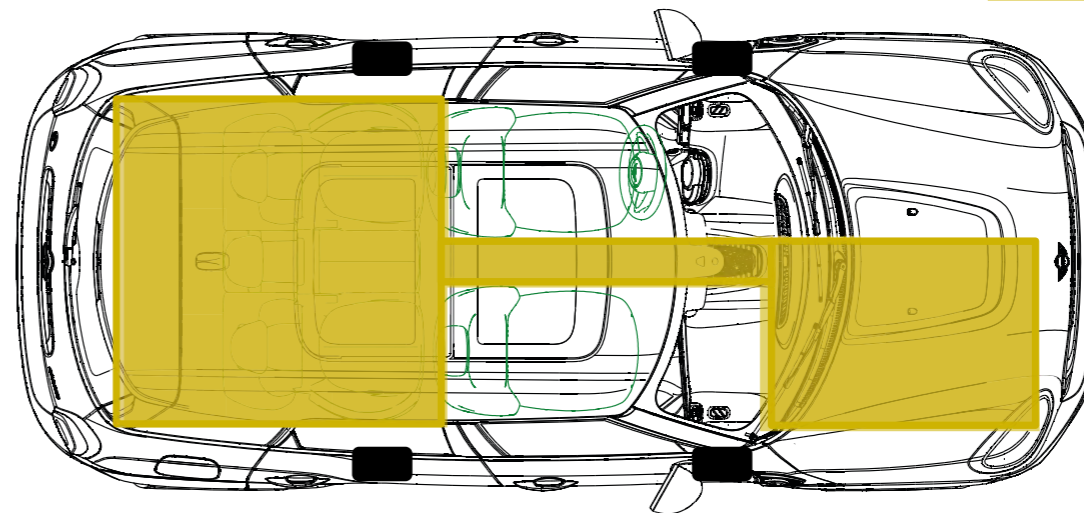

”

According to the German Social Accident Insurance Institution for the Administrative Sector (VBG), the general rule for providing breakdown assistance for electric vehicles is:

“There is no risk involved in providing breakdown assistance for vehicles with high-voltage systems, as long as no attempts are made to eliminate faults by interfering with the voltage-system.”<sup>43</sup>

# 3. DISABLE DIRECT HAZARDS/SAFETY REGULATIONS.



# ARRIVAL AT SCENE OF ACCIDENT.

The high-voltage system of the MINI Cooper S E Countryman ALL4 is completely insulated, so there is no conductive connection to the body. It's also intrinsically safe and should switch off automatically in the event of an accident. At the same time, the high-voltage cables outside the high-voltage battery discharge in just a few seconds. Therefore, by the time you arrive at the scene of the accident, there will typically no longer be any electrical potential left in the orange cables and high-voltage components outside the high-voltage battery. The high-voltage components and orange cables must not be touched.

## YOU SHOULD THEN FOLLOW THE RESCUE SHEET INSTRUCTIONS OUTLINED BELOW:

If the engine is running or the display is active, press the START/STOP button on the instrument cluster to turn off the ignition

You should then deactivate the high-voltage system. You have two options to choose from:

- Pull on the high-voltage disconnect at the rear (connector in the boot).
- Sever the high-voltage disconnect at the front (cut-through option).

# LOCATION OF THE HIGH-VOLTAGE DISCONNECT.

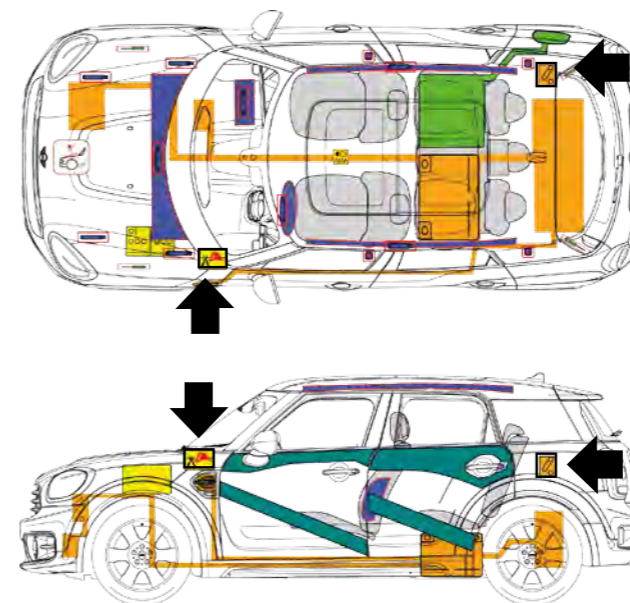

-  Airbag
-  SRS control unit
-  High-strength zone
-  Fuel tank
-  High-voltage disconnect
-  Stored gas inflator
-  Pedestrian protection active system
-  High-voltage disconnect (cut-through option)
-  High-voltage power cable/component
-  Seat belt pretensioner
-  Gas strut/preloaded spring
-  Low-voltage battery
-  High-voltage battery

# DEACTIVATING THE HIGH-VOLTAGE SYSTEM AT THE REAR OF THE VEHICLE.

The high-voltage disconnect (Service Disconnect) is integrated as a separate component on the right-hand side at the back of the luggage compartment.

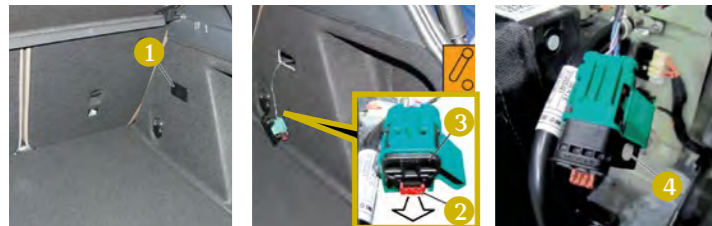

Procedure:  
Open the tailgate and take out the service flap **1** on the right-hand side.

Press the red connector switch fuse **2** downwards and pull it out. Disconnect the black connector for the high-voltage disconnect (Service Disconnect) **3** in the direction of the arrow.

The high-voltage system is deactivated when the bore hole **4** is completely free.

## HINT.

The connector and socket of the high-voltage disconnect cannot be pulled apart entirely.

# DEACTIVATING THE HIGH-VOLTAGE SYSTEM IN THE VEHICLE'S ENGINE COMPARTMENT.

If the high-voltage disconnect is not accessible in the rear, you can deactivate the high-voltage system using the second high-voltage disconnect at the front. Because this is a cut-through option, you should have the appropriate tool to hand.





# SAFETY REGULATIONS.

- Do not touch damaged high-voltage cables or components. The cables are always orange and located outside the car interior. If in doubt, call the relevant rescue coordination centre for qualified electricians.
- Do not attempt to repair high-voltage components during rescue and recovery missions. This should only be done by those qualified to work on vehicles with high-voltage systems. Due to the location of high-voltage components, damage is not likely during a rescue mission. If damage does occur, no efforts should be made to repair it. The damaged area may need to be covered with insulating material. Work on high-voltage components may only be carried out in a certified specialist workshop.
- Even after the high-voltage system has been switched off, there may still be residual voltage. This will dissipate, however, in a few seconds.
- You can find additional information in the rescue manual.
- You can find the rescue manual at: <https://aos.bmwgroup.com/service/rescue-info>

# IMPORTANT DISPLAYS.

You should be familiar with the following displays in the instrument cluster, so that you can quickly determine the state of the high-voltage components:

Check Control message	Meaning	Cause
	Insulation fault, fault in the high-voltage interlock loop	Integrated high-voltage battery system faulty. Once the engine is turned off, it may no longer be possible to drive. Please locate the closest MINI Service centre.
	High-voltage system shut down	High-voltage system in de-energised state for maintenance, service and repairs. High-voltage disconnect (Service Disconnect) removed. Circuit of high-voltage interlock loop interrupted.

You can find a picture of the instrument cluster on page 17 of this brochure.

# 4. ACCESS TO THE OCCUPANTS.



# NO UNIQUE CHALLENGES ASSOCIATED WITH RESCUING PASSENGERS.

The following applies when rescuing passengers: because the same materials are used in the MINI Countryman plug-in hybrid as in all other models of the same series, you will not experience any additional difficulties during the rescue procedure. We also considered the easiest possible way of rescuing occupants during the development stage. The use of rescue cutters and spreaders is therefore not a problem.



**HOW DO YOU PROCEED WHEN A HIGH-VOLTAGE BATTERY PACK OR PARTS OF IT HAVE SEPARATED OR DETACHED FROM THE VEHICLE DURING AN ACCIDENT AND SOMEONE IS TRAPPED IN THE VEHICLE?**

- Approved personal protective equipment must be worn.
- The high-voltage battery pack must not be touched directly.
- If high-voltage components or high-voltage cables have been damaged (e.g. open components, torn-off cables), these damaged areas must not be touched.
- If work in these areas is unavoidable, the damaged parts or high-voltage battery pack should be covered with an electrically insulated material.
- The state of the high-voltage battery pack needs to be observed (e.g. presence of smoke, sounds, sparks, increase in heat).
- Water needs to be made available to cool the high-voltage battery pack.

**WHAT IS A SUITABLE INSULATING MATERIAL FOR COVERING LIVE PARTS?**

- A suitable, electrically insulating, supple material (e.g. in accordance with IEC 61112) is recommended.
- The fire service's tarpaulin is generally a sheet of polyethylene. Due to frequent use of the tarpaulin and potential damage, using it to insulate live parts is not recommended.



# SEAT ADJUSTMENT.

Manually adjustable seats.

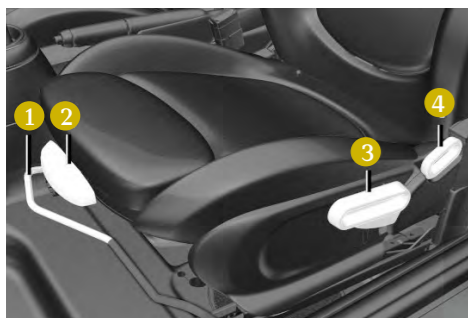

1. Longitudinal.
2. Seat cushion.
3. Height.
4. Backrest inclination .

Electrically adjustable seats.

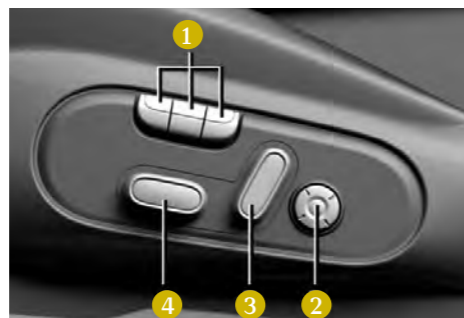

1. Memory function.
2. Lumbar support.
3. Backrest inclination.
4. Longitudinal, height, seat inclination.

Mechanical adjustment of the steering column.

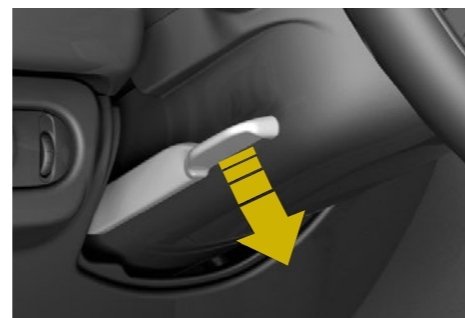

1. Pull the lever down.
2. Adjust the longitude and height of the steering wheel.
3. Push the lever back up.



# 5. STORED ENERGY/ LIQUIDS/GASES/ SOLIDS.



# AN OVERVIEW OF THE DRIVE SYSTEM.

The plug-in hybrid system of the MINI Cooper S E Countryman ALL4 combines two powerful drives: a powerful electric motor with lithium-ion high-voltage battery and a new generation of internal combustion engines. What that means for you, the emergency crews: in addition to new safety indications for electric vehicles, the well-known guidelines for dealing with conventional vehicles with internal combustion engines also need to be followed. We would like to introduce the drive components that make up the MINI plug-in hybrid system here.

An overview of high-voltage components:

- ① 3-cylinder petrol engine.
- ② 6-speed automatic transmission.
- ③ High-voltage starter motor generator.
- ④ High-voltage battery unit.
- ⑤ Fuel pressure tank (36 l).
- ⑥ Electrical machine
- ⑦ Electrical machine electronics.
- ⑧ Convenience charging electronics.



# LOCATION OF THE HIGH-VOLTAGE BATTERY.

In the MINI Cooper S E Countryman ALL4, the high-voltage battery is installed in the underbody in place of the left half of the tank, which increases safety.



- ① Fuel tank (36 l).
- ② High-voltage battery (7.6 kWh).

# STORED ENERGY.

Because the electrical potential of the high-voltage battery unit is much higher than 60 V, it's not unreasonable to wonder if there's a risk of electric shock when touching the MINI plug-in hybrid vehicle. The general rule is: the MINI Cooper S E Countryman ALL4 is intrinsically safe, meaning the system should switch itself off in the event of an accident with deployed airbags. At the same time, the cables outside the high-voltage battery and the components of the high-voltage system automatically discharge in just a few seconds. Therefore, by the time you arrive at the scene of the accident, there will no longer be any electrical potential in the orange cables outside the high-voltage battery, thus eliminating electrical hazard.

## Additional measures have also been taken:

- The high-voltage system is completely insulated and has no conductive connection to the body.
- As a result, you can generally touch the body of the vehicle without exposing yourself to the risk of electric shock.
- The high-voltage battery is located in the underbody in a position outside the crash zone for most accidents, meaning virtually no external forces can affect it on impact. The battery module is also positioned inside a housing, further increasing safety.



## HOW DO YOU PROCEED AT THE SCENE OF AN ACCIDENT WHEN THE HIGH-VOLTAGE BATTERY PACK IN THE VEHICLE IS DAMAGED BUT NOT ON FIRE?

- The damaged high-voltage battery pack must not be touched directly.
- The state of the high-voltage battery pack needs to be observed (e.g. presence of smoke, sounds, sparks, increase in heat).
- Water needs to be made available to cool the high-voltage battery pack.
- If the temperature of the high-voltage battery pack is much higher than the outside temperature and is continually rising, the housing of the high-voltage battery pack needs to be cooled with water.



# LEAKING FLUIDS.

There is very little free electrolyte in the high-voltage battery. A leak may release electrolyte, refrigerant, refrigerator oil or solvent vapours. In the event of skin or eye exposure, flush these with lots of water and seek medical attention immediately thereafter.

## WHAT DO YOU NEED TO BE AWARE OF WHEN DEALING WITH A HIGH-VOLTAGE BATTERY PACK LEAKING ELECTROLYTE FOLLOWING AN ACCIDENT?

- Electrolytes tend to be irritating, flammable and potentially corrosive.
- Conventional binding agents need to be used.  
  
HINT: Any fluids leaking from high-voltage battery packs tend to be refrigerant and not electrolyte. There are only small amounts (millilitres) of electrolyte throughout the individual cells.
- Skin exposure to electrolyte and the inhalation of released gases resulting from chemical reactions with leaking electrolyte should be avoided at all costs. (HINT: Personal protective equipment should be selected based on the situation).
- If your skin becomes exposed to the contents of the high-voltage battery packs or their gases, the affected areas need to be flushed with lots of water. Soiled clothing needs to be taken off and cleaned. Medical attention should then be sought.

# GASES.

A range of measures have been incorporated into the MINI Cooper S E Countryman ALL4 that ensure safety in regular operation and in the event of a fire. The high-voltage system is designed to withstand accidents to a degree that exceeds what is legally required. The high-voltage battery has a variety of features such as the degassing unit that ensure controlled extraction of gases/fire gases from the high-voltage battery.



1 Fixing screws.

2 Degassing unit.

The degassing unit ensures controlled extraction of fire gases from the high-voltage battery.

In the event of a fire, it's primarily inflammable gases and other hazardous substances that escape. Be careful! Don't inhale the fumes. Make sure there is a sufficient supply of fresh air.



## WHAT ARE THE RISKS WHEN A HIGH-VOLTAGE BATTERY PACK RELEASES GASES?

- The gases are irritating, flammable, potentially corrosive and must therefore not be inhaled.
- The recovery process should be aborted and the next steps discussed with the fire service head of operations.
- The danger zone surrounding the vehicle should also be expanded.
- If possible, a high-voltage battery pack releasing gases should be cooled with water.

HINT: As a rule, gases can also be perceived by an acrid, pungent odour.

## IS A HIGH-VOLTAGE BATTERY PACK LIKELY TO RELEASE GASES IN THE EVENT OF A FIRE?

- Yes. Both the high-voltage battery and its individual cells are fitted with mechanical safety devices, which, for instance, open in response to an increase in temperature and pressure resulting from a fire, thus releasing gases and pressure as a preventive measure.

HINT: Self-contained breathing apparatuses are required when working in an exposed environment. A spray of water should be applied to contain vapours and gases.

# 6. FIRE.



# HIGH-VOLTAGE BATTERIES IN THE EVENT OF A FIRE.

Several questions arise in the event of a fire: How much fire and smoke is there? Is there a risk of explosion? And can fire services even extinguish these kinds of fires?

” The results of extinguishing tests carried out by DEKRA show that: **ELECTRIC CARS WITH LITHIUM-ION BATTERIES ARE ALSO SAFE IN THE EVENT OF A FIRE.**<sup>4</sup>

” BRANDSchutz/Deutsche Feuerwehr-Zeitung, the German publication for fire services, was pleased with the results: **“There were no explosions. There was much less smoke generated by the burning batteries than there is with burning gasoline or diesel or a vehicle fire. The same applies to heat radiation. The temperatures tended to stay below those of burning fuel.”**<sup>5</sup>



## IS A HIGH-VOLTAGE BATTERY PACK LIKELY TO EXPLODE IN THE EVENT OF A FIRE?

· An explosion of the entire high-voltage battery pack can be ruled out due to the corresponding safety technology.

HINT: A bursting of open, defective cells accompanied by an exothermic reaction cannot be ruled out.

## COULD THE HIGH-VOLTAGE BATTERY PACK CATCH FIRE AT A LATER TIME FOLLOWING AN ACCIDENT?

· Yes. As is the case with conventional vehicles involved in an accident, the risk of a delayed fire cannot be ruled out, which applies to damaged high-voltage battery packs in particular.

# EXTINGUISHING.

In principle, a lithium-ion battery fire can be extinguished with lots of water. Furthermore, all standard and approved extinguishing agents can be used in accordance with the relevant safety guidelines and recommended safe distances. By taking the usual safety precautions and observing safe distances, the safety of lithium-ion high-voltage batteries can also be ensured in the event of a fire.

# PLASTICS: FIRE GAS HAZARDS.

The same plastics are used in the MINI Cooper S E Countryman ALL4 as in other MINI models. There are therefore no significant differences in the burning behaviour and extinguishing characteristics. As is the case with conventional vehicle fires, harmful mixes of gas are released and should not be inhaled. The general rule is therefore:

**As with fires involving conventional vehicles, personal protective equipment and breathing apparatuses should be worn.**

# 7. SUBMERSION IN WATER.





# RECOVERING FROM THE WATER.

The procedure is generally identical to that of conventional vehicles. Once the vehicle has been recovered from the water, the high-voltage system needs to be switched off, which is done by pulling on the connector of the high-voltage disconnect and disconnecting the 12 V battery (negative terminal).

The following should be observed after the recovery procedure:

- Observe vehicle thoroughly.
- Store vehicle outdoors with sufficient clearance to combustible materials.
- Provide access for fire brigade.



## ARE CERTAIN RISKS LIKELY IF AN ELECTRIC/HYBRID VEHICLE IS UNDERWATER?

- A high-voltage system submersed in water does not increase the risk of electric shock.
- The recovery procedure is identical to that of conventional vehicles.



# 8. TOWING/ TRANSPORTATION/ STORAGE.



# TOWING.

If you want to tow the MINI Cooper S E Countryman ALL4, the following needs to be taken into account:

The vehicle may only be transported on a loading platform. To avoid damaging the automatic transmission and the electrical machine with reduction gearbox, towing is not permitted on both axles (A) or the rear axle (B)!

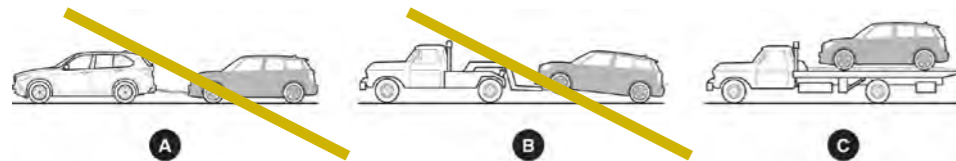

## WHAT DO YOU NEED TO BE AWARE OF WHEN LOADING AN ELECTRIC/HYBRID VEHICLE FOLLOWING A SERIOUS ACCIDENT?

- HINT: Instructions can be found in the owner's handbook for the vehicle or the rescue sheet.
- The high-voltage system should be deactivated before loading (e.g. switch off ignition, use existing disconnect if applicable, disconnect 12 V battery).
- In the event of transfer to the authorities/recovery company, these need to be informed of the vehicle's type of drive and the measures taken by the fire service (e.g. high voltage deactivation). Specifically, they must be informed of the potential danger from damaged high-voltage components or high-voltage components which have come into contact with water (e.g. electric shock or risk of fire, including delayed fire, from the high-voltage battery pack).
- National regulations/standards for loading and transport must be observed.

- If the vehicle is transferred to third parties (e.g. workshop or disposal company), we recommend informing them of the measures taken (e.g. disconnect activated, 12 V battery disconnected, high-voltage components which have come into contact with water, etc.).
- When lifting the vehicle with a crane/jack, working with a winch or loading it, it's important to ensure that no high-voltage components are/become damaged.

## WHAT DO YOU NEED TO BE AWARE OF WHEN TRANSPORTING/TOWING ELECTRIC/HYBRID VEHICLES THAT HAVE BEEN INVOLVED IN AN ACCIDENT?

- If possible, vehicles with a damaged high-voltage battery pack should be transported to the nearest suitable specialist workshop or to a safe place of storage.



# VEHICLE TRANSPORT.

The MINI Cooper S E Countryman ALL4 can be considered intrinsically safe in the event of a breakdown or minor accident. If you need to transport the vehicle over a short distance, please be aware of the following:

- If the 12-volt onboard electrical system is still working, you can make the vehicle roll by starting it with the START/STOP button, applying the brakes and switching the selector lever to N.
- Jump-starting or charging the vehicle via the 12-volt onboard electrical system in the event of a breakdown is not permitted.
- The vehicle may not be towed by the axles, as the electric motor could supply current to the high-voltage system. The car may only be transported on a flatbed vehicle.
- The car shouldn't be towed any further than is absolutely essential. The best way to move the vehicle is with all four wheels stationary, which is why we recommend using, for instance, a recovery crane.
- To bring the vehicle out of the danger zone, you may pull it at a walking pace over a short distance.
- Secure the vehicle during transport, for example using tension straps pulled through the wheel rims.
- Please observe national regulations.

# TRANSPORT OF THE HIGH-VOLTAGE BATTERY.

In the event of a serious accident, the high-voltage battery may need to be separated or detached from the vehicle. If the high-voltage battery is damaged, it's safe to assume that the contact protection is also damaged. In this very unlikely event, electrical, thermal and chemical risks do exist. Adequate personal protective equipment is required.

The technical state needs to be evaluated to rule out potential danger. The test, which is based on the 'Guidelines for determining suitability for transport', may only be carried out by qualified electricians or 'experts in working on high-voltage battery units'.

# STORING THE VEHICLE.

If the MINI Cooper S E Countryman ALL4 is not taken straight to a MINI workshop after an accident, it must be stored in an outdoor parking area reserved for vehicles involved in an accident. This will not result in any surprises. This is because, as an intrinsically safe vehicle, the same safety regulations apply as with conventional vehicles.

Please be sure to leave ample space between the vehicle and other vehicles, buildings and other flammable objects. It goes without saying that the parking area should be accessible for the fire service and secured against unauthorised access. You should also mark the MINI Cooper S E Countryman ALL4 as an electric vehicle.



# STORING HIGH-VOLTAGE BATTERIES.

High-voltage batteries and their components may only be stored in rooms with automatic sprinkler systems. Fire alarms also have to be installed to ensure that any fires are detected even outside of operating hours. High-voltage batteries may only be stored on shelves and not on the floor. Individual cell modules need to be stored in a lockable safety cabinet. If a high-voltage battery is faulty but not damaged, it can also be stored in the transport container of the starter batteries.

## STORAGE OF DAMAGED BATTERY PACKS.

The battery pack is considered to be damaged in the following instances:

- High-voltage battery with visible signs of fire
- High-voltage battery with perceptible heat generation at individual locations
- Smoke or fumes emerging from the high-voltage battery
- High-voltage battery externally deformed or torn open

Damaged high-voltage battery packs need to be stored outdoors in a specially labelled container for at least 48 hours before disposal.

The storage location needs to be at least 5 metres from buildings, vehicles and other combustible materials such as waste containers. High-voltage batteries with external damage need to be stored in an acid-resistant, leak-proof trough to prevent leakage of electrolyte into the soil. An uncontrolled flow of extinguishing water also needs to be prevented.

# 9. REFERENCES.

- S. 3 | <sup>1</sup> Rescue manual and rescue sheet:  
<https://aos.bmwgroup.com/service/rescue-info>
- S. 3 | <sup>2</sup> German Association of the Automotive Industry (VDA):  
Accident assistance and recovering vehicles with high-voltage systems:  
<https://www.vda.de/en/services/Publications/rescue-and-towing-of-vehicles-with-high-voltage-systems.html> <https://www.vda.de/en/services/Publications/rescue-and-towing-of-vehicles-with-high-voltage-systems.html>
- S. 19 | <sup>3</sup> Flyer on breakdown assistance for electric and hybrid vehicles by the German Social Accident Insurance Institution for the Administrative Sector (VBG), version: 2.0/2015-10.
- S. 44 | <sup>4</sup> DEKRA e.V., press release no. 142 dated 29 October 2012.
- S. 44 | <sup>5</sup> Markus Egelhaaf et al.: Firefighting of Lithium-ion Traction Batteries, BRANDSchutz/Deutsche Feuerwehr-Zeitung 2/2013, p. 109. [www.kohlhammer-feuerwehr.de](http://www.kohlhammer-feuerwehr.de)

