



## Hybrid 2007 Model

### *Emergency Response Guide*



© 2006 Toyota Motor Corporation  
All rights reserved. This document may not be  
altered without the written permission of Toyota Motor Corporation.

2007 CAMRY Hybrid ERG REV - (6/19/06)

## Foreword

In May 2006, Toyota released the Toyota CAMRY gasoline-electric hybrid vehicle in North America. Except where noted in this guide, basic vehicle systems and features for the CAMRY hybrid are the same as those on the conventional non-hybrid Toyota CAMRY. To educate and assist emergency responders in the safe handling of the CAMRY hybrid technology, Toyota published this CAMRY hybrid Emergency Response Guide.

High voltage electricity powers the electric motor, generator, air conditioning (A/C) compressor, and inverter/converter. All other automotive electrical devices such as the headlights, horn, radio, and gauges are powered from a separate 12 Volt battery. Numerous safeguards have been designed into the CAMRY hybrid to help ensure the high voltage, approximately 245 Volts, Nickel Metal Hydride (NiMH) Hybrid Vehicle (HV) battery pack is kept safe and secure in an accident.

The CAMRY hybrid utilizes the following electrical systems:

- Nominal 12 Volts DC
- Maximum 34 Volts AC
- Nominal 245 Volts DC
- Maximum 650 Volts AC

CAMRY Hybrid Features:

- The body electrical system rated at 12 Volts negative chassis ground.
- A high voltage Electric Power Steering (EPS) assist motor rated at 34 Volts.
- The high voltage hybrid vehicle battery pack is rated at 245 Volts.
- A high voltage motor driven air conditioning compressor rated at 245 Volts.
- A boost converter in the inverter assembly boosts to 650 Volts the maximum available voltage to the electric motor.

- Supplemental Restraint System (SRS) consisting of dual stage frontal airbags, driver knee airbag, front seatback mounted side impact airbags, side curtain airbags, and front seat belt pretensioners.

High voltage electrical safety is an important factor in the emergency handling of the CAMRY *Hybrid Synergy Drive* system. It is important to recognize and understand the disabling procedures and warnings throughout the guide.

Additional topics in the guide include:

- Toyota CAMRY hybrid identification.
- Major *Hybrid Synergy Drive* component locations and descriptions.
- Extrication, fire, recovery, and additional emergency response information.
- Roadside assistance information.

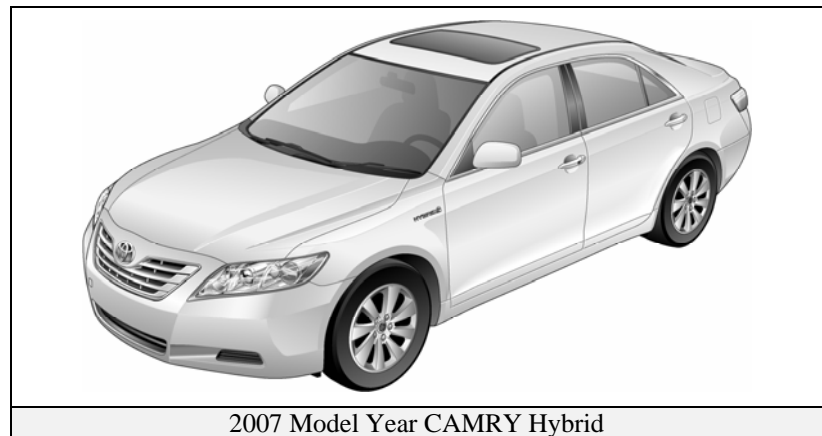

2007 Model Year CAMRY Hybrid

This guide is intended to assist emergency responders in the safe handling of a Toyota CAMRY hybrid vehicle during an incident.

**NOTE:**

Emergency Response Guides for Toyota alternative fuel vehicles may be viewed at <http://techinfo.toyota.com>.

<b>Table of Contents</b>	<b>Page</b>
About the CAMRY Hybrid	1
CAMRY Hybrid Identification	2
Hybrid Synergy Drive Component Locations & Descriptions	5
Smart Key System	8
Hybrid Synergy Drive Operation	10
Hybrid Vehicle (HV) Battery Pack	11
Low Voltage Battery	12
High Voltage Safety	13
SRS Airbags & Seat Belt Pretensioners	15
Emergency Response	17
Extrication	17
Fire	21
Recovery/Recycling of the NiMH HV Battery Pack	22
Spills	22
First Aid	23
Submersion	23
Roadside Assistance	24

## About the CAMRY Hybrid

The CAMRY joins the PRIUS and HIGHLANDER as hybrid models for Toyota. *Hybrid Synergy Drive* means that the vehicle contains a gasoline engine and an electric motor for power. The two hybrid power sources are stored on board the vehicle:

1. Gasoline stored in the fuel tank for the gasoline engine.
2. Electricity stored in a high voltage Hybrid Vehicle (HV) battery pack for the electric motor.

The result of combining these two power sources is improved fuel economy and reduced emissions. The gasoline engine also powers an electric generator to recharge the battery pack; unlike a pure all electric vehicle, the CAMRY hybrid never needs to be recharged from an external electric power source.

Depending on the driving conditions, one or both sources are used to power the vehicle. The following illustration demonstrates how the CAMRY hybrid operates in various driving modes.

- ① During light acceleration at low speeds, the vehicle is powered by the electric motor. The gasoline engine is shut off.
- ② During normal driving, the vehicle is powered mainly by the gasoline engine. The gasoline engine also powers the generator to recharge the battery pack.

- ③ During full acceleration, such as climbing a hill, both the gasoline engine and the electric motor power the vehicle.
- ④ During deceleration, such as when braking, the vehicle regenerates the kinetic energy from the front wheels to produce electricity that recharges the battery pack.
- ⑤ While the vehicle is stopped, the gasoline engine and electric motor are off, however the vehicle remains on and operational.

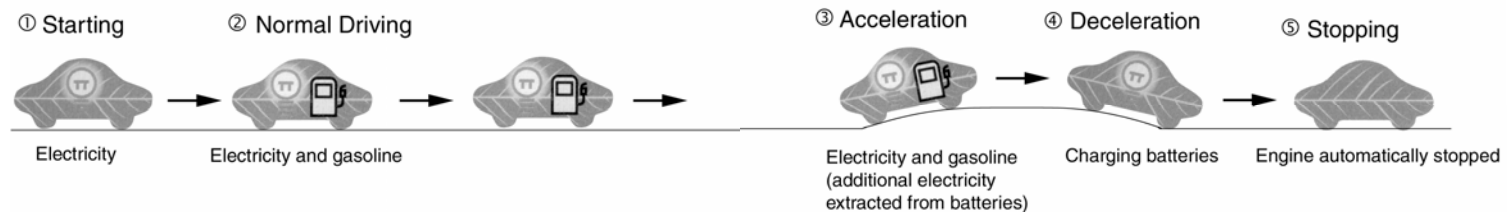

## CAMRY Hybrid Identification

In appearance, the 2007 CAMRY hybrid is nearly identical to the conventional non-hybrid Toyota CAMRY. The CAMRY hybrid is a 4-door sedan. Exterior, interior, and engine compartment illustrations are provided to assist in identification.

The alphanumeric 17 character Vehicle Identification Number (VIN) is provided in the front windshield cowl and driver door pillar.

Example VIN: JTNBB46S840020208  
4T1BB46S7U0031258

A CAMRY hybrid is identified by the first 6 alphanumeric characters **JTNBB4** or **4T1BB4**.

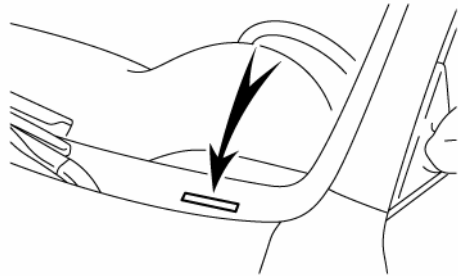

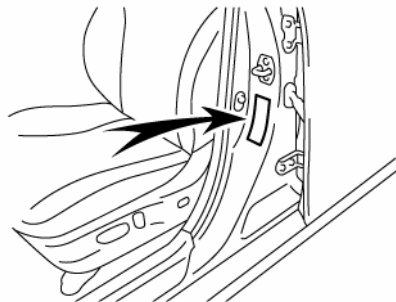

Driver Side Windshield



Driver Side B-Pillar

## Exterior

- ❶  logo on the trunk lid.
- ❷  logo on the trunk lid.
- ❸  logo on each front fender.
- ❹ Gasoline fuel filler door located on the driver side rear quarter panel.



Exterior Driver Side View



Exterior Front View



Exterior Rear View



Exterior Rear and Passenger Side View

## CAMRY Hybrid Identification (Continued)

### Interior

- ⑤ The instrument cluster (speedometer, fuel gauge, and warning lights) located in the dash behind the steering wheel, is different than the one on the conventional, non-hybrid CAMRY.
- ⑥ In place of a tachometer, a fuel meter showing miles per gallon (mpg) consumption is used. A multi-information display showing energy flow is provided in the center of the speedometer.

#### NOTE:

If the vehicle is shut off, the instrument cluster gauges will be “blacked out,” not illuminated.

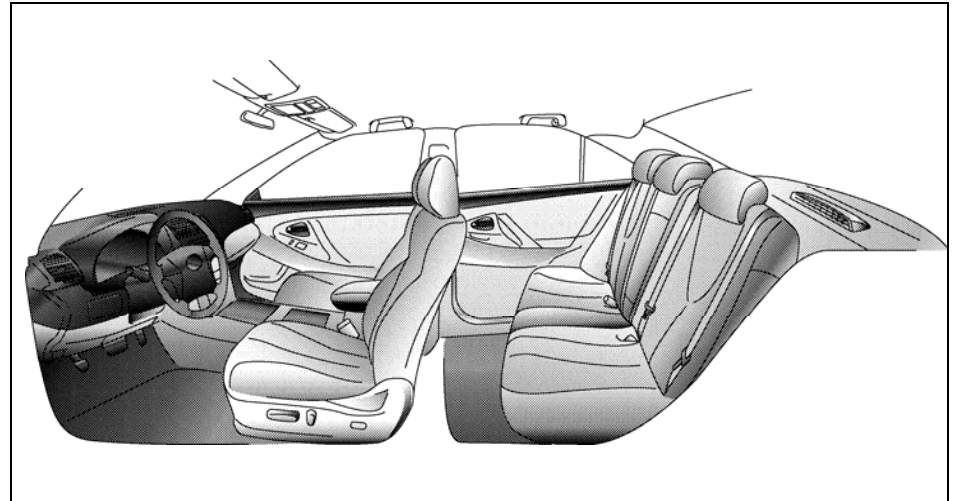

Interior View



Instrument Cluster View

## CAMRY Hybrid Identification (Continued)

### Engine Compartment

- ⑦ 2.4 liter aluminum alloy gasoline engine.
- ⑧ High voltage inverter/converter assembly with logo on the plastic cover.

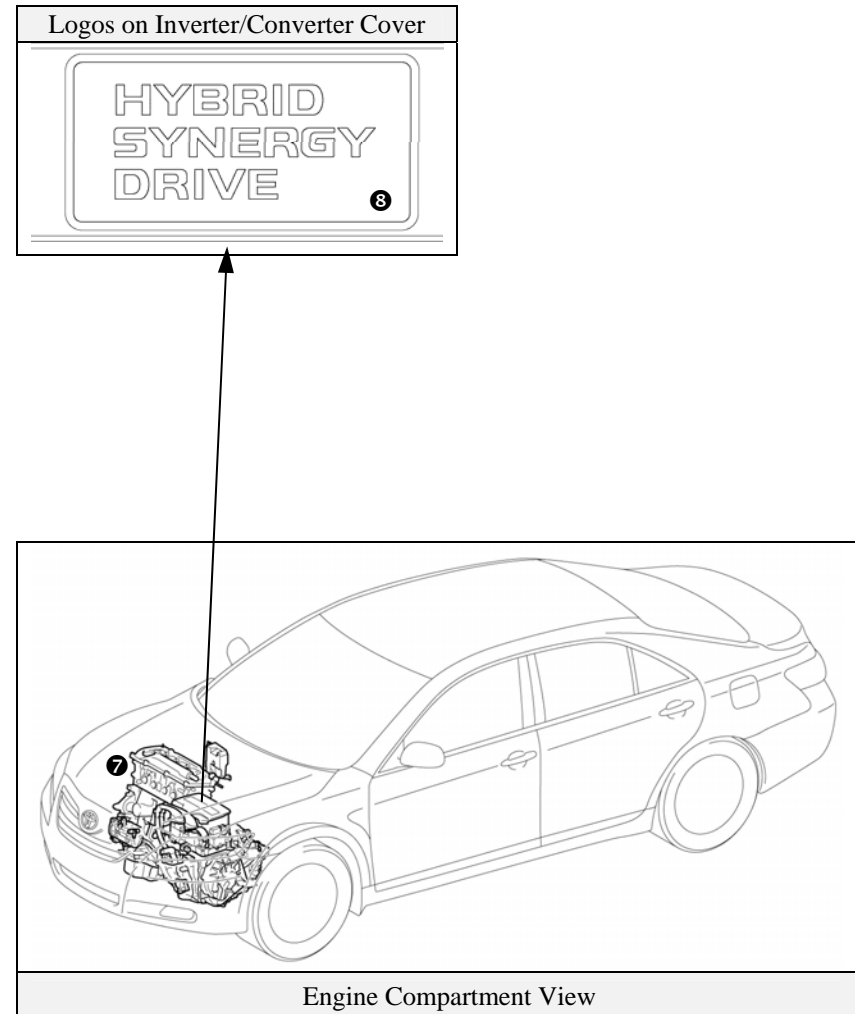

## Hybrid Synergy Drive Component Locations & Descriptions

Component	Location	Description
12 Volt <b>1</b> Auxiliary Battery	Trunk Area	A lead-acid battery that supplies power to the low voltage devices.
Hybrid <b>2</b> Vehicle (HV) Battery Pack	Trunk Area, Mounted to Cross Member and behind Rear Seat	245 Volt Nickel Metal Hydride (NiMH) battery pack consisting of 34 low voltage (7.2 Volt) modules connected in series.
Power <b>3</b> Cables	Under Passenger Side Floor Pan and Engine Compartment	Orange colored power cables carry high-voltage Direct Current (DC) between the HV battery pack, inverter/converter, and A/C compressor. These cables also carry 3-phase Alternating Current (AC) between the inverter/converter, electrical motor, and generator.
Inverter/ Converter <b>4</b>	Engine Compartment	Boosts and inverts the high voltage electricity from the HV battery pack to 3-phase AC electricity that drives the electric motor. The inverter/converter also converts AC electricity from the electric generator and electric motor (regenerative braking) to DC that recharges the HV battery pack.
Gasoline <b>5</b> Engine	Engine Compartment	Provides two functions: 1) Powers vehicle. 2) Powers generator to recharge the HV battery pack. The engine is started and stopped under control of the vehicle computer.
Electric <b>6</b> Generator	Transaxle	3-phase high voltage AC generator that is contained in the transaxle and recharges the HV battery pack.
Electric <b>7</b> Motor	Transaxle	3-phase high voltage AC permanent magnet electric motor contained in the transaxle. Used to power the front wheels.
A/C <b>8</b> Compressor	Engine Compartment	3-phase high voltage AC electrically driven motor compressor.

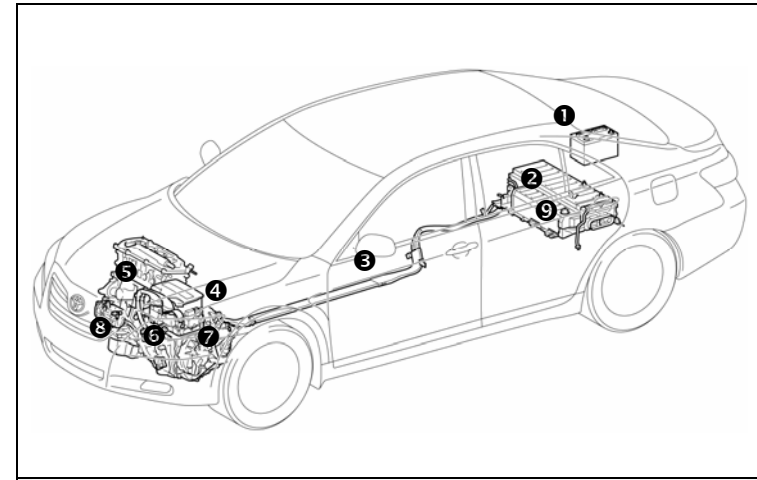

Hybrid Synergy Drive Components

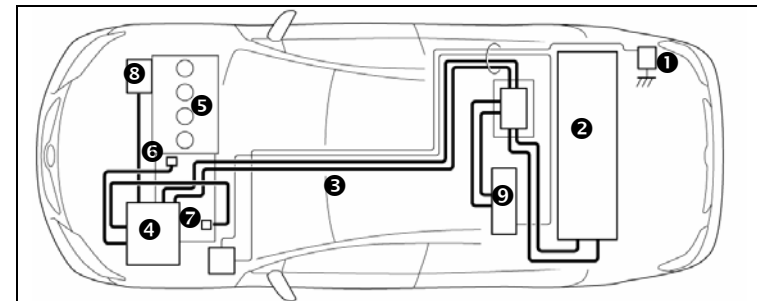

Components (Top View) and High Voltage Power Cables



## Hybrid Synergy Drive Component Locations & Descriptions (Continued)

Component	Location	Description
12 Volt DC-DC Converter ⑨	Inside HV Battery Pack Assembly in Trunk Area	Converts (steps down) 245 Volts DC from the HV battery pack to 12 Volts DC for low voltage vehicle power.
Fuel Tank ⑩ and Fuel Line	Driver Side Under Floor Pan	The fuel tank provides gasoline via the fuel line to the engine. The fuel line is routed along the driver side under the floor pan.

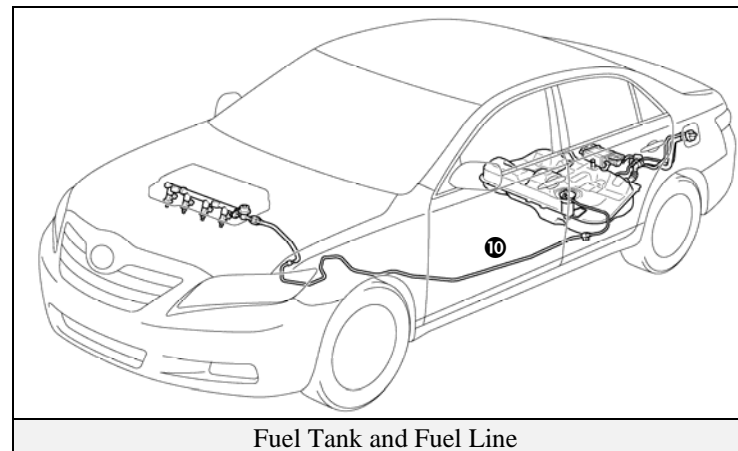

Fuel Tank and Fuel Line

## Hybrid Synergy Drive Component Locations & Descriptions (Continued)

### Key Specifications:

Gasoline Engine:	147 hp (110 kW), 2.4-liter Aluminum Alloy Engine
Electric Motor:	141 hp (105 kw), Permanent Magnet Motor
Transmission:	Automatic Only
HV Battery:	245 Volt Sealed NiMH Battery Pack
Curb Weight:	3,638 lbs / 1,650 kg
Fuel Tank:	17.2 gals / 65 liters
Fuel Economy:	40 / 38 (City/Hwy) miles/gal
Liters/100 km:	5.9 / 6.3 (City/Hwy) liters/100 km
Frame Material:	Steel Unibody
Body Material:	Steel Panels

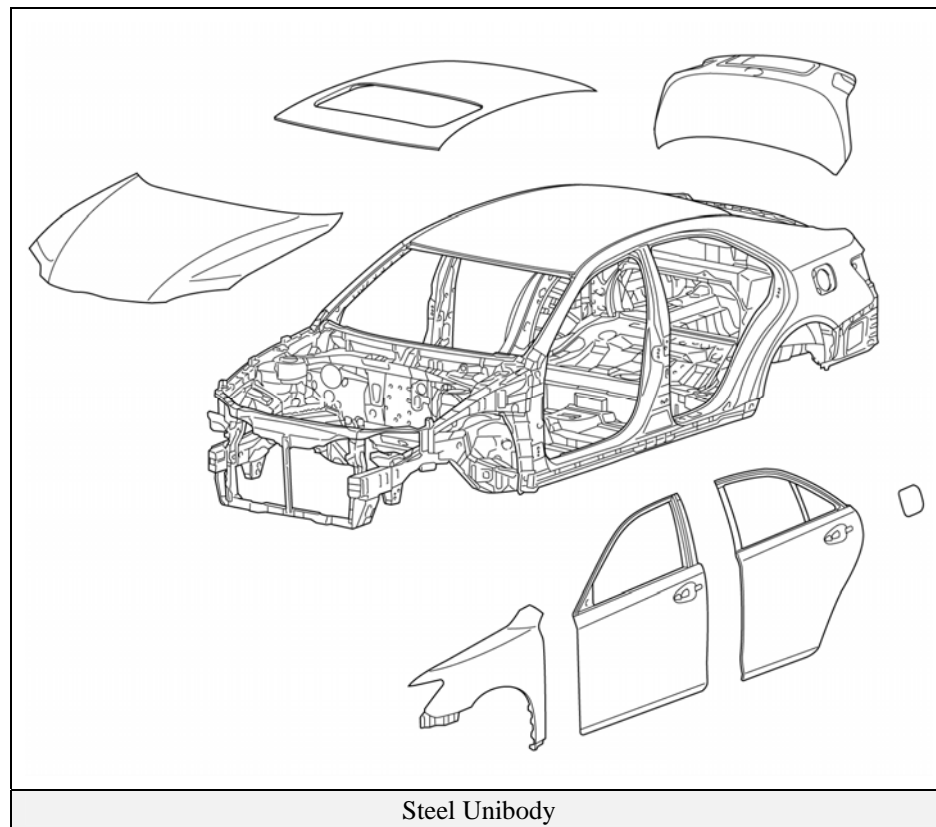

## Smart Key System

The CAMRY hybrid smart key system consists of a smart key transceiver that communicates bi-directionally enabling the vehicle to recognize the smart key in close proximity to the vehicle. Once recognized, the smart key will allow the user to lock and unlock the doors without pushing smart key buttons, and start the vehicle without inserting it into an ignition switch.

### Smart Key Features:

- Passive (remote) function to lock/unlock the doors, unlock the trunk, and start the vehicle.
- Wireless transmitter to lock/unlock the doors and unlock the trunk lid.
- Hidden metal cut key locks/unlocks doors and trunk.

### Door (Lock/Unlock)

Three methods are available to lock/unlock the doors.

1. Pushing wireless smart key lock/unlock buttons.
2. Touching the sensor on the backside of either exterior front door handle, with the smart key in close proximity to the vehicle, unlocks the doors. Pushing the lock button on either exterior front door handle locks the doors.
3. Inserting the hidden metal cut key in the driver door lock and turning clockwise once unlocks the driver door, twice unlocks all doors. To lock all doors turn the key counter clockwise once. Only the driver door contains an exterior door lock for the metal cut key.

### Trunk (Lock/Unlock)

Three methods are available to lock/unlock the trunk.

1. Pushing wireless smart key trunk opener button.
2. Operating the trunk lock release lever located on the floor next to the driver seat.
3. Inserting the hidden metal cut key in trunk lock and turning clockwise unlocks the trunk lid. For valet service, turning the metal cut key counter clockwise locks and deactivates the smart key and release lever from opening the trunk.

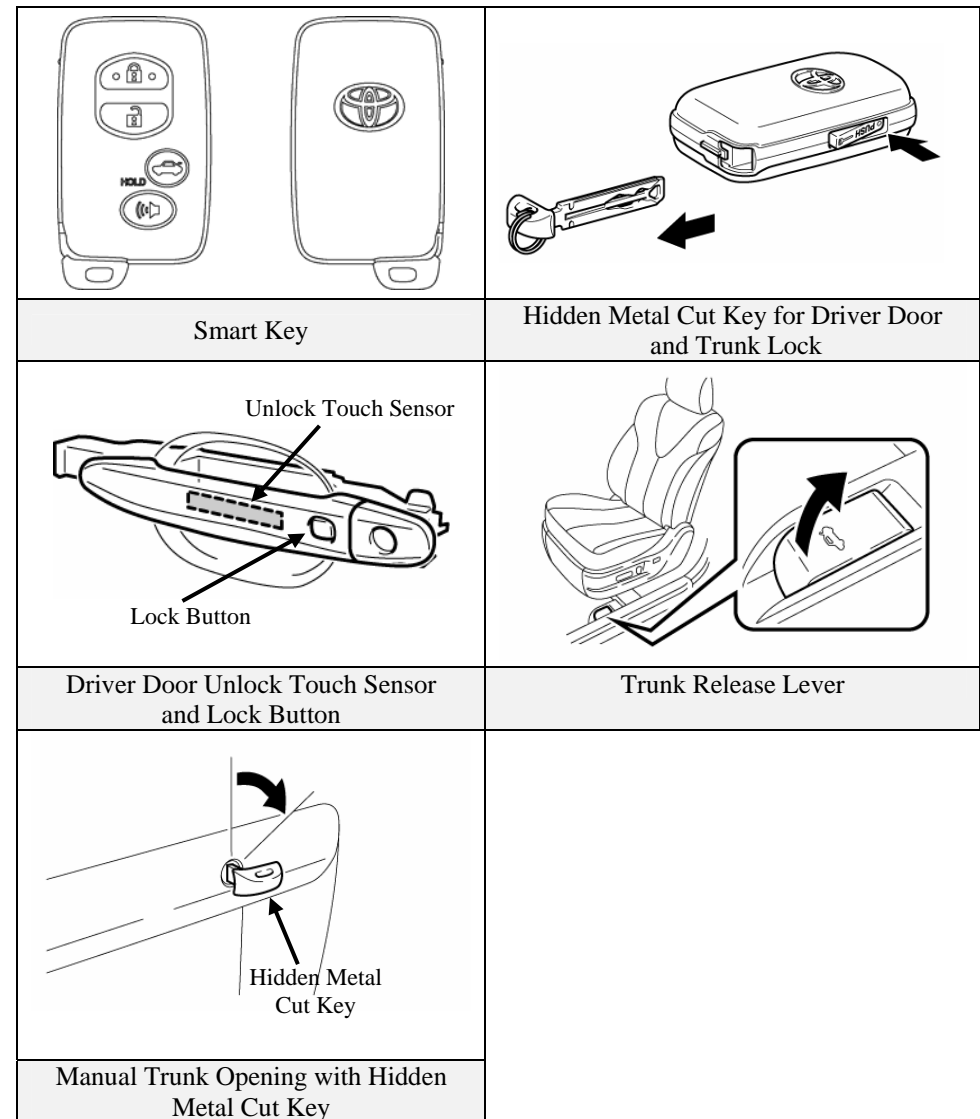

## Smart Key System (Continued)

### Vehicle Starting/Stopping

The smart key has replaced the conventional metal cut ignition key, and the power button with an integral status indicator light has replaced the ignition switch. The smart key only needs to be in close proximity to the vehicle.

- With the brake pedal released, the first push of the power button operates the accessory mode, the second push operates the ignition-on mode, and the third push turns the ignition off again.

Ignition Mode Sequence (Brake pedal released):

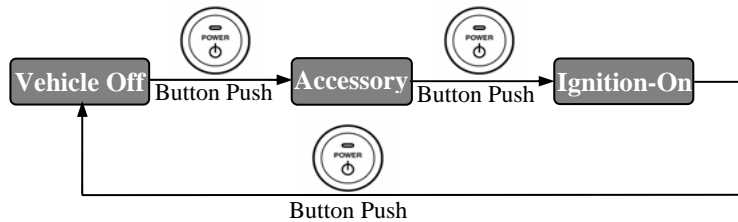

- Starting the vehicle takes priority over all other ignition modes and is accomplished by depressing the brake pedal and pushing the power button once. To verify the vehicle has started, the power button status indicator light is off and the **READY** light is illuminated in the instrument cluster.
- If the internal smart key battery is dead, it cannot communicate with the vehicle. In order for the vehicle to recognize the smart key, the driver must hold the smart key next to the power button while pushing.
- Once the vehicle has started and is on and operational (**READY-ON**), the vehicle is shut off by bringing the vehicle to a complete stop, placing the gearshift lever in **Park**, and then depressing the power button once.

Ignition Mode	Power Button Indicator Light
Off	Off
Accessory	Amber
Ignition-On	Amber
Brake Pedal Depressed	Green
Vehicle Started ( <b>READY-ON</b> )	Off
Malfunction	Blinking Amber

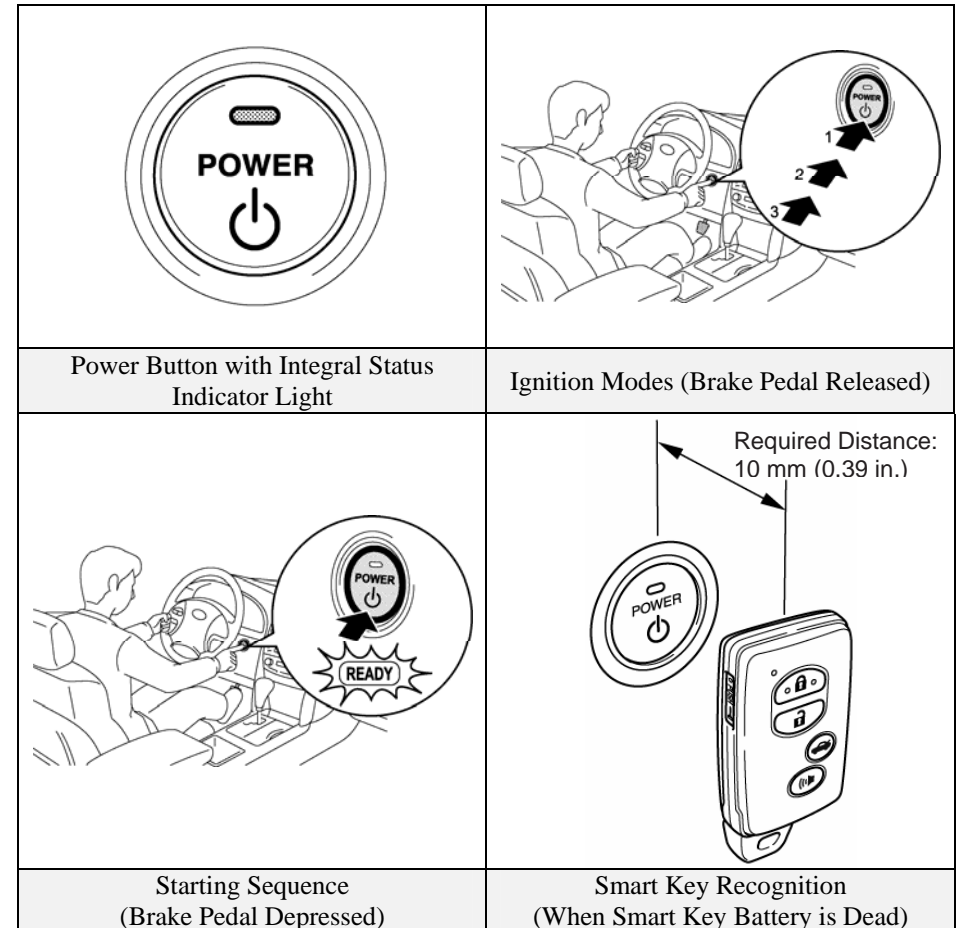

## Hybrid Synergy Drive Operation

Once the **READY** indicator is illuminated in the instrument cluster, the vehicle may be driven. However, the gasoline engine does not idle like a typical automobile and will start and stop automatically. It is important to recognize and understand the **READY** indicator provided in the instrument cluster. When lit, it informs the driver that the vehicle is on and operational even though the gasoline engine may be off and the engine compartment is silent.

### Vehicle Operation

- With the CAMRY hybrid, the gasoline engine may stop and start at any time while the **READY** indicator is on.
- Never assume that the vehicle is shut off just because the engine is off. Always look for the **READY** indicator status. The vehicle is shut off when the **READY** indicator is off.
- The vehicle may be powered by:
  1. The electric motor only.
  2. The gasoline engine only.
  3. A combination of both the electric motor and the gasoline engine.
- The vehicle computer determines the mode in which the vehicle operates to improve fuel economy and reduce emissions. The driver cannot manually select the mode.

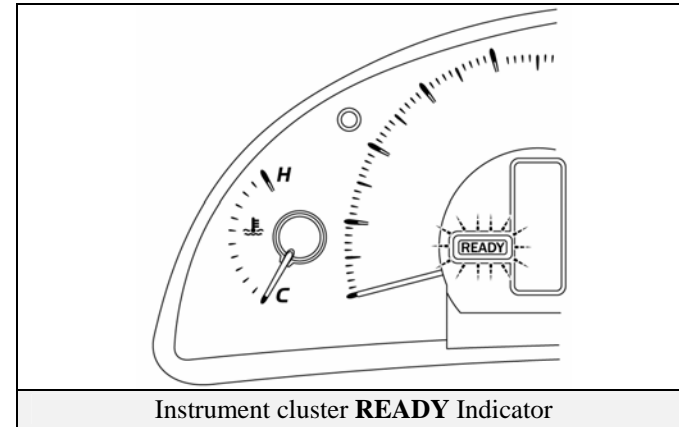

## Hybrid Vehicle (HV) Battery Pack

The CAMRY hybrid contains a high voltage, Hybrid Vehicle (HV) battery pack that contains sealed Nickel Metal Hydride (NiMH) battery modules.

### HV Battery Pack

- The HV battery pack is enclosed in a metal case and is securely mounted in the trunk area behind the rear seat. The metal case is isolated from high voltage and concealed by fabric covers.
- The HV battery pack consists of 34 low voltage (7.2 Volt) NiMH battery modules connected in series to produce approximately 245 Volts. Each NiMH battery module is sealed in a non-spillable plastic case.
- The electrolyte used in the NiMH battery module is an alkaline mixture of potassium and sodium hydroxide. The electrolyte is absorbed into the battery cell plates and forms a gel that will not normally leak, even in a collision.
- In the unlikely event that the battery pack is overcharged, the modules vent gases directly outside the vehicle through a vent hose.

HV Battery Pack	
Battery pack voltage	245 V
Number of NiMH battery modules in the pack	34
NiMH battery module voltage	7.2 V
NiMH battery module dimensions	5 x 1 x 11 (118 x 20 x 276 mm)
NiMH module weight	2.3 lbs (1.0 kg)
NiMH battery Pack dimensions	8 x 34 x 19 in. (190 x 850 x 495 mm)
NiMH battery Pack weight	114.6 lbs (52 kg)

### Components Powered by the HV Battery Pack

- Electric Motor
- Inverter/Converter
- A/C Compressor
- Power Cables
- DC-DC Converter
- Electric Generator

### HV Battery Pack Recycling

- The HV battery pack is recyclable. Contact the nearest Toyota dealer or Toyota customer assistance at:

United States: (800) 331-4331    Canada: (888) 869-6828

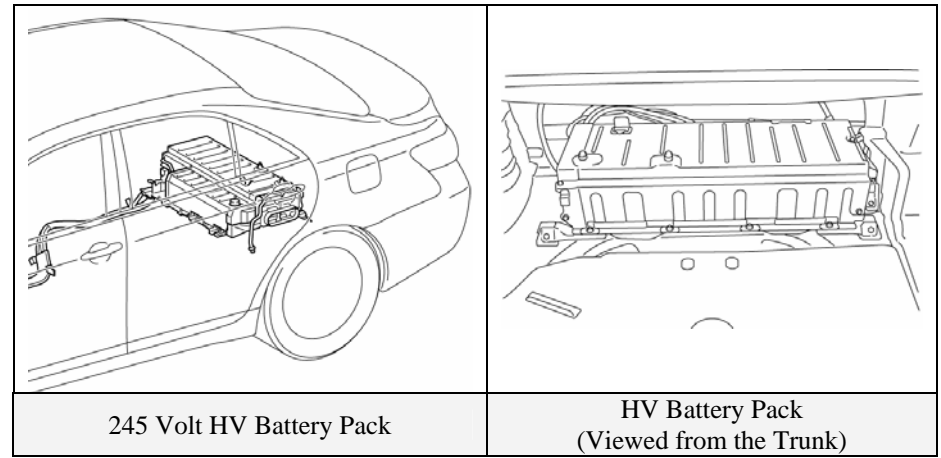

245 Volt HV Battery Pack

HV Battery Pack  
(Viewed from the Trunk)

## Low Voltage Battery

### Auxiliary Battery

- The CAMRY hybrid contains a lead-acid 12 Volt battery. The 12 Volt auxiliary battery powers the vehicle's low electrical system similar to a conventional vehicle. As with conventional vehicles, the auxiliary battery is grounded to the metal chassis of the vehicle.
- The auxiliary battery is located in the trunk and concealed by a plastic cover on the passenger side in the rear quarter panel well.

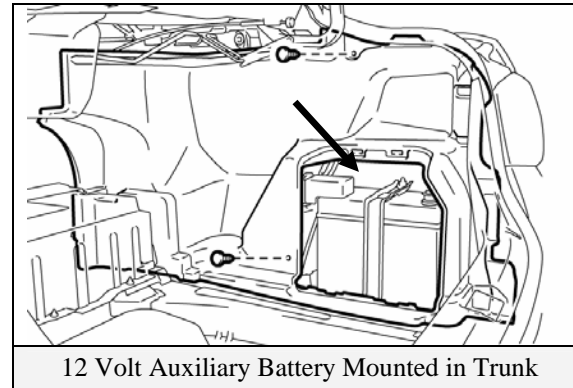

12 Volt Auxiliary Battery Mounted in Trunk

## High Voltage Safety

The HV battery pack powers the high voltage electrical system with DC electricity. Positive and negative orange colored high voltage power cables are routed from the battery pack, under the vehicle floor pan to the engine compartment, and connected to the inverter/converter. The inverter/converter contains a circuit that boosts the HV battery voltage from 245 up to 650 Volts DC. The inverter creates 3-phase AC to power the motor and generator located in the transaxle. Power cables are routed from the inverter to each high voltage motor (electric motor, electric generator, and A/C compressor). The following systems are intended to help occupants in the vehicle and emergency responders safe from high voltage electricity.

### High Voltage Safety System

- A high voltage fuse ❶ provides short circuit protection in the HV battery pack.
- Positive and negative high voltage power cables ❷ connected to the HV battery pack are controlled by 12 Volt normally open relays ❸. When the vehicle is shut off, the relays stop electrical flow from leaving the HV battery pack.

#### **⚠ WARNING:**

*The high voltage system may remain powered for up to 10 minutes after the vehicle is shut off or disabled. To prevent serious injury or death from severe burns or electric shock, avoid touching, cutting or breaching any orange high voltage power cable or high voltage component.*

- Both positive and negative power cables ❷ are insulated from the metal chassis, so there is no possibility of electric shock when touching the metal chassis.
- A ground fault monitor ❹ continuously monitors for high voltage leakage to the metal chassis while the vehicle is running. If a malfunction is detected, the hybrid vehicle computer ❹ will illuminate the master warning light ⚠ in the instrument cluster and indicate “CHECK HYBRID SYSTEM” on the multi-information display.
- The HV battery pack relays will automatically open to stop the electrical flow in a collision sufficient to activate the SRS.

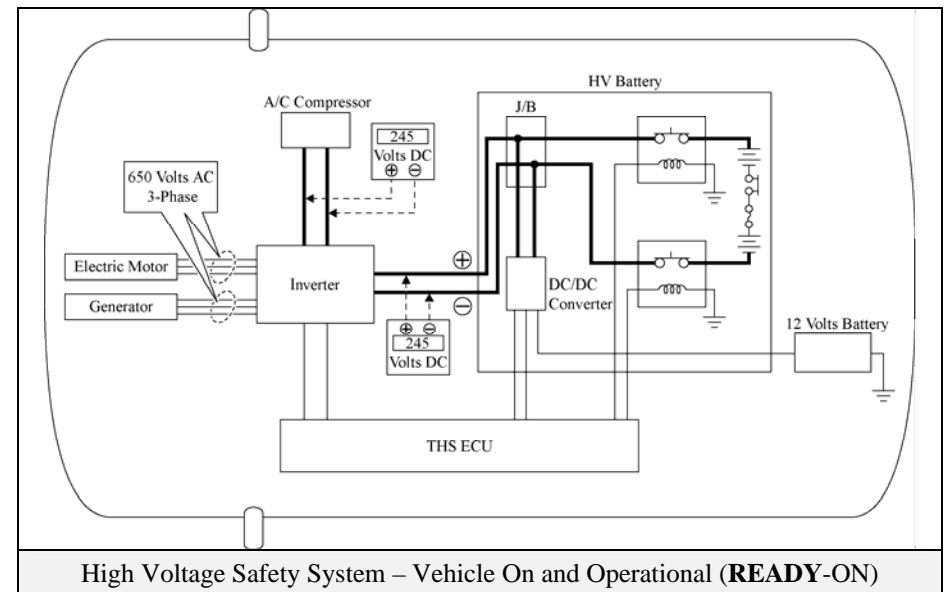
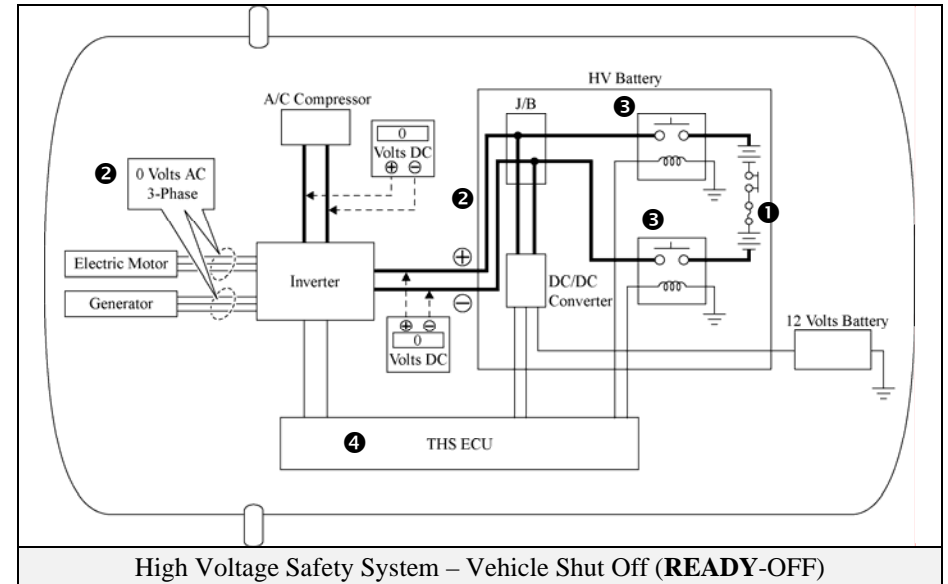



## High Voltage Safety (Continued)

### Electronic Power Steering System

The CAMRY hybrid is equipped with a 34 Volt AC assist motor for the Electric Power Steering (EPS) system. The EPS computer generates 34 Volts from the 12 Volt system. The 34 Volt wires are isolated from the metal chassis and routed a short distance from the EPS computer to the EPS assist motor in the engine compartment.

#### NOTE:

34 Volt AC has a higher arc potential than the normal 12 Volt DC.

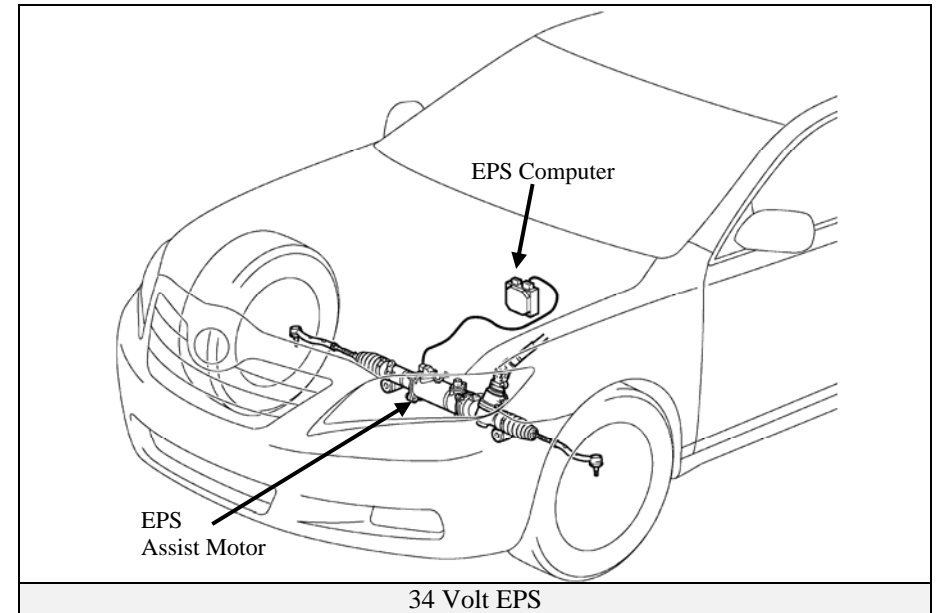

## SRS Airbags & Seat Belt Pretensioners

### Standard Equipment

- Electronic frontal impact sensors (2) are mounted in the engine compartment ❶ as illustrated on the following page.
- Front seat belt pretensioners are mounted near the base of the B-pillar ❷.
- A frontal dual stage airbag for the driver ❸ is mounted in the steering wheel hub.
- A frontal dual stage airbag for the front passenger ❹ is integrated into and deploys through the top of the dashboard.
- The SRS computer ❺ is mounted on the floor pan underneath the center console. It also contains an impact sensor.
- Front electronic side impact sensors (2) are mounted near the base of the B-pillars ❻.
- Rear electronic side impact sensors (2) are mounted near the base of the C-pillars ❼.
- Front seat side impact airbags ❸ are mounted in the seatbacks.
- Side curtain airbags ❹ are mounted along the outer edge inside the roof rails.
- A driver front knee airbag ❶ is mounted on the driver side lower portion of the dash.

### NOTES:

The front seatback mounted side impact airbags and the side curtain airbags may deploy independently of each other.

The driver knee airbag deploys simultaneously with the driver frontal airbag. The seat belt pretensioners may also deploy when the frontal airbags deploy.

The CAMRY hybrid is equipped with a standard front passenger occupant classification system that may prohibit the deployment of the passenger frontal airbag, seatback mounted side impact airbag, and seat belt pretensioner. If the passenger occupant classification system prohibits deployment during an SRS event, the passenger SRS will not re-arm nor deploy.

### **WARNING:**

*The SRS may remain powered for up to 90 seconds after the vehicle is shut off or disabled. To prevent serious injury or death from unintentional SRS deployment, avoid crushing, cutting or breaching the SRS components.*

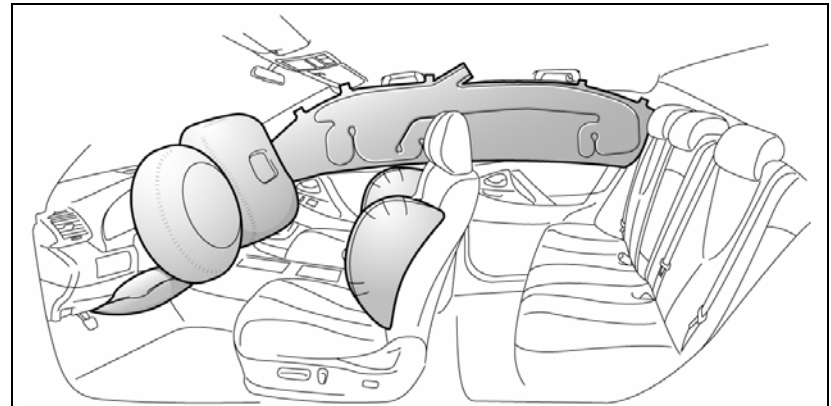

Driver Knee Airbag, Frontal, Front Seatback Mounted Side, and Side Curtain Airbags

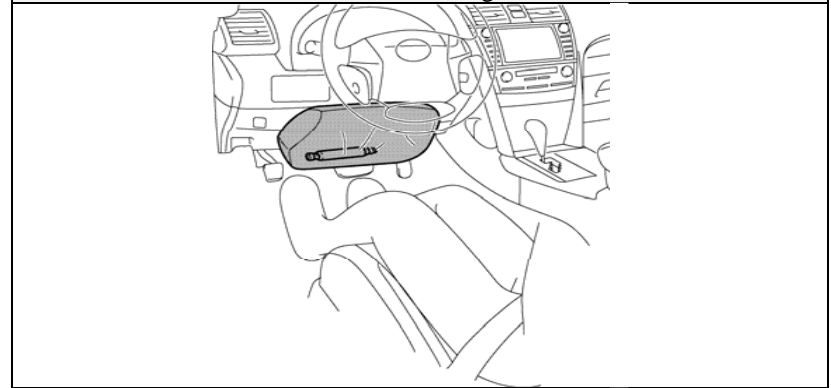

Driver Knee Airbag

# SRS Airbags & Seat Belt Pretensioners (Continued)

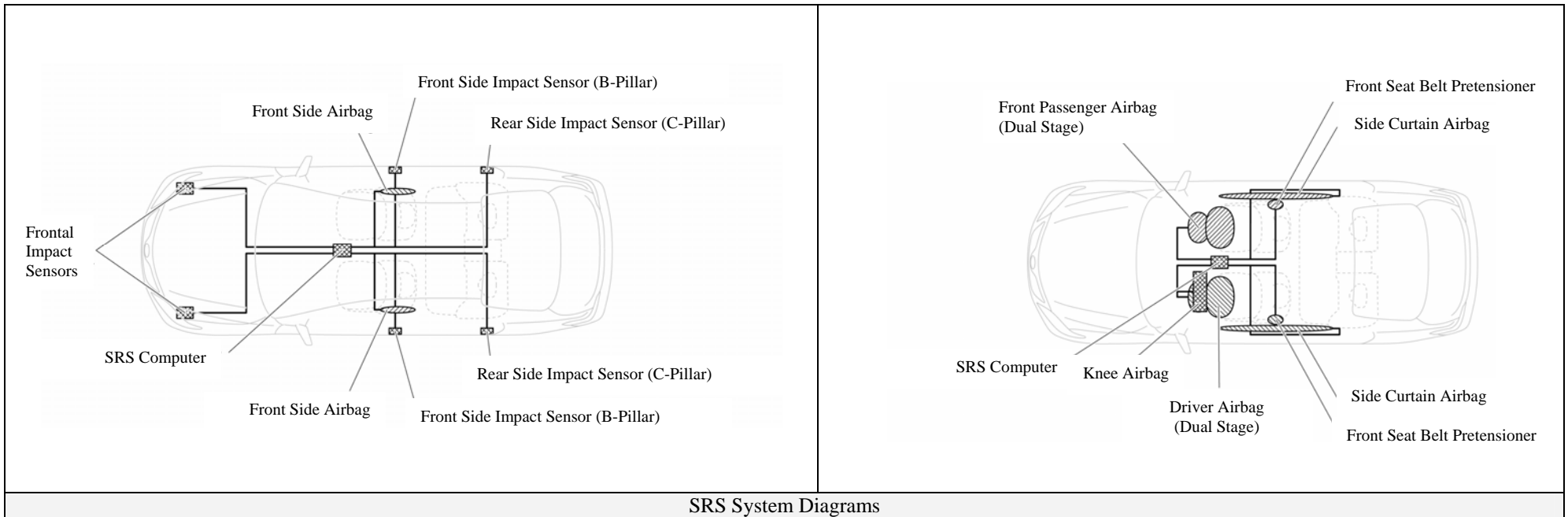
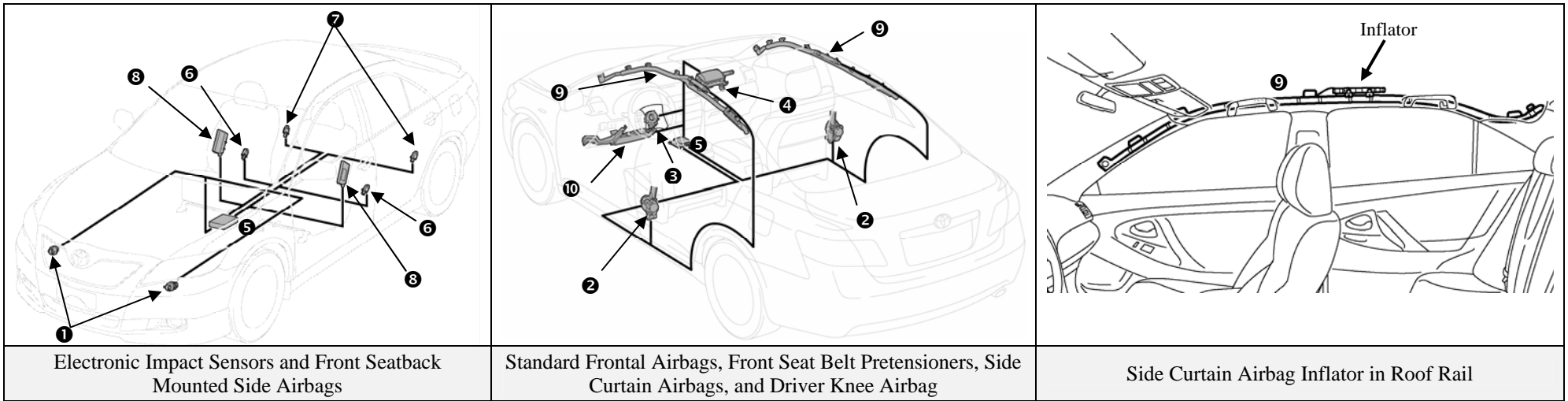

## Emergency Response

On arrival, emergency responders should follow their standard operating procedures for vehicle incidents. Emergencies involving the CAMRY hybrid may be handled like other automobiles except as noted in these guidelines for Extrication, Fire, Recovery, Spills, First Aid, and Submersion.

### **⚠ WARNING:**

- *Never assume that the CAMRY hybrid is shut off simply because it is silent.*
- *Always observe the instrument cluster for the **READY** indicator status to verify whether the vehicle is on or shut off. The vehicle is shut off when the **READY** indicator is off.*
- *Failure to shut off the vehicle before emergency response procedures are performed may result in serious injury or death from the unintentional deployment of the SRS or severe burns and electric shock from the high voltage electrical system.*

### Extrication

- **Immobilize Vehicle**  
Chock wheels and set the parking brake.  
Move the shift lever to the **Park** position.
- **Disable Vehicle**  
Performing either of the following procedures will shut the vehicle off and disable the HV battery pack, SRS, and gasoline fuel pump.

#### **Procedure #1**

1. Confirm the status of **READY** indicator in the instrument cluster.
2. If the **READY** indicator is illuminated, the vehicle is on and operational. Shut off the vehicle by pushing the power button once.
3. The vehicle is already shut off if the instrument cluster lights and the **READY** indicator are not illuminated. Do **not** push the power button because the vehicle may start.
4. Keep the smart key at least 3.3 feet (1 meter) away from the vehicle

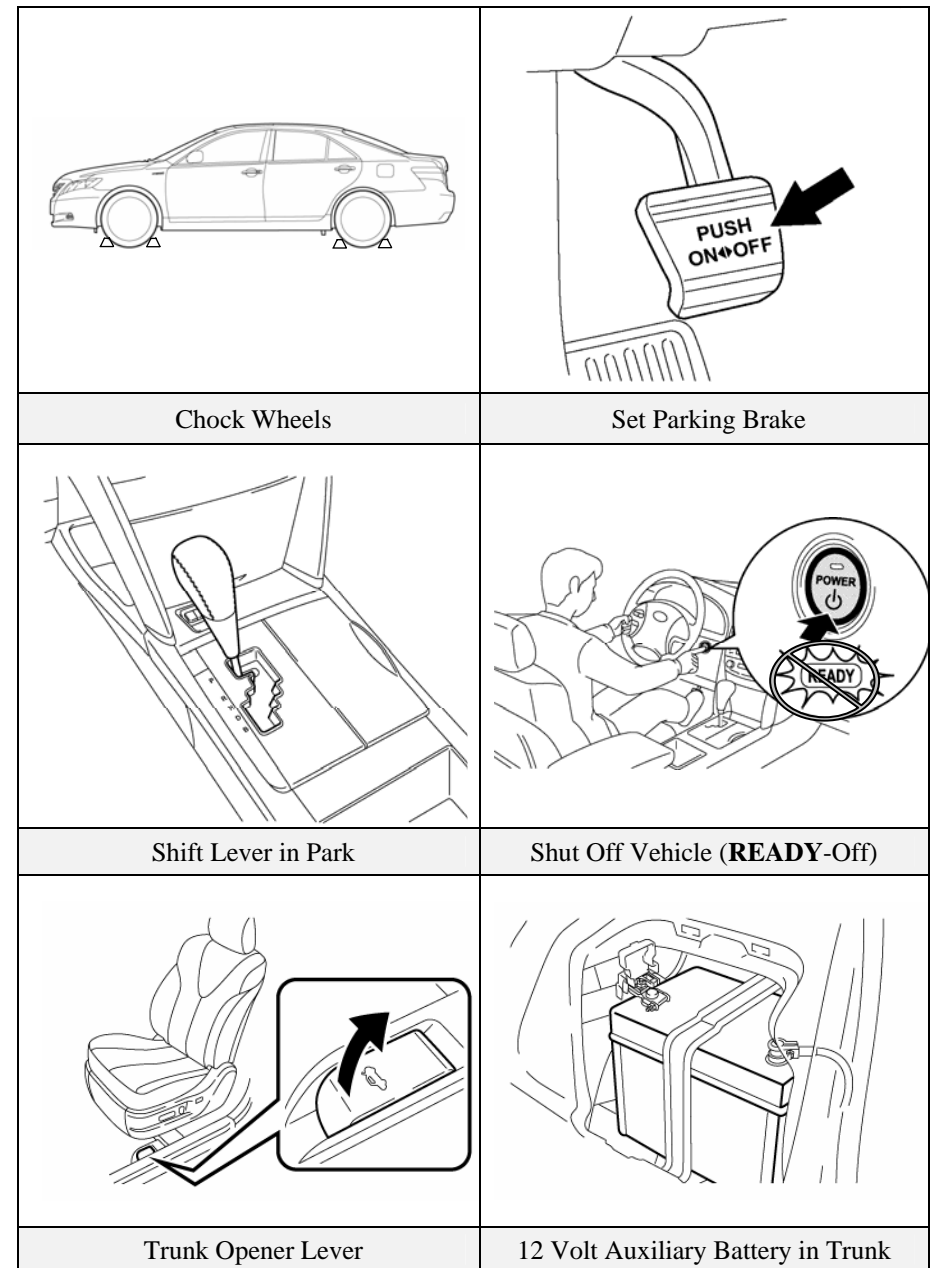

## Emergency Response (Continued)

### Extrication (Continued)

5. If the smart key cannot be found, disconnect the 12 Volt auxiliary battery in the trunk.

#### NOTE:

Before disconnecting the 12 Volt auxiliary battery, if necessary, reposition the power seats, lower the windows, unlock the doors, and open the fuel door as required. A manual fuel door release is located in the trunk (see illustration in the Roadside Assistance section page 25). Once the 12 Volt auxiliary battery is disconnected power controls will not operate.

#### Procedure #2 (Alternate if power button is inaccessible)

1. Disconnect the 12 Volt auxiliary battery in the trunk.
2. Remove the driver side fuse box cover in the engine compartment.
3. Remove the IGCT No. 2 fuse (10A red colored) in the engine compartment junction block as illustrated. If the correct fuse cannot be recognized, pull all of the fuses in the fuse block.

#### WARNING:

- *The high voltage system may remain powered for up to 10 minutes after the vehicle is shut off or disabled. To prevent serious injury or death from severe burns or electric shock, avoid touching, cutting, or breaching any orange high voltage power cable or high voltage component.*
- *The SRS may remain powered for up to 90 seconds after the vehicle is shut off or disabled. To prevent serious injury or death from unintentional SRS deployment, avoid crushing, cutting or breaching the SRS components.*
- *If none of the disabling procedures can be performed, proceed with caution as there is no assurance that the high voltage electrical system, SRS, or fuel pump are disabled.*

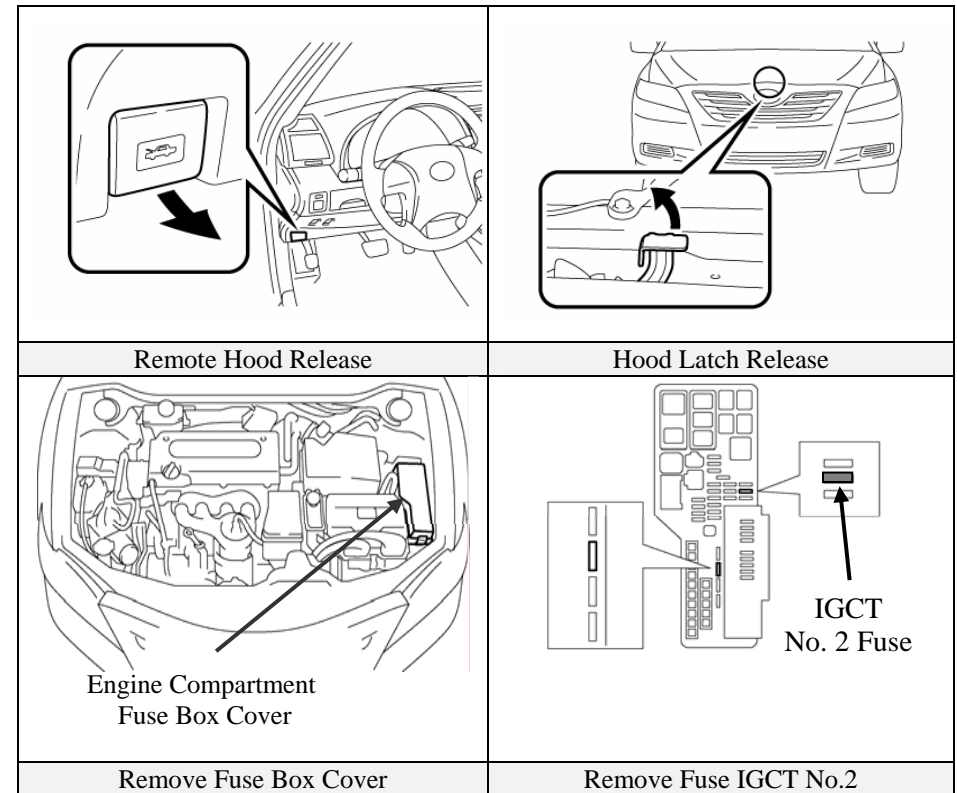

## Emergency Response (Continued)

### Extrication (Continued)

- Stabilize Vehicle

Crib at (4) points directly under the front and rear pillars.  
Do not place cribbing under the high voltage power cables, exhaust system, or fuel system.

**NOTES:**

The CAMRY hybrid is equipped with a tire pressure warning system that by design prevents pulling the metal valve stem with integral transmitter. Snapping the stem with pliers or removing the valve cap and Schrader valve will release the air in the tire.

- Access Patients

Glass Removal

Use normal glass removal procedures as required.

SRS Awareness

Responders need to be cautious when working in proximity to undeployed airbags and seat belt pretensioners. Front dual stage airbags automatically ignite both stages within a fraction of a second.

Door Removal/Displacement

Doors can be removed by conventional rescue tools such as hand, electric, and hydraulic tools. In certain situations, it may be easier to pry back the vehicle body to expose and unbolt the hinges.

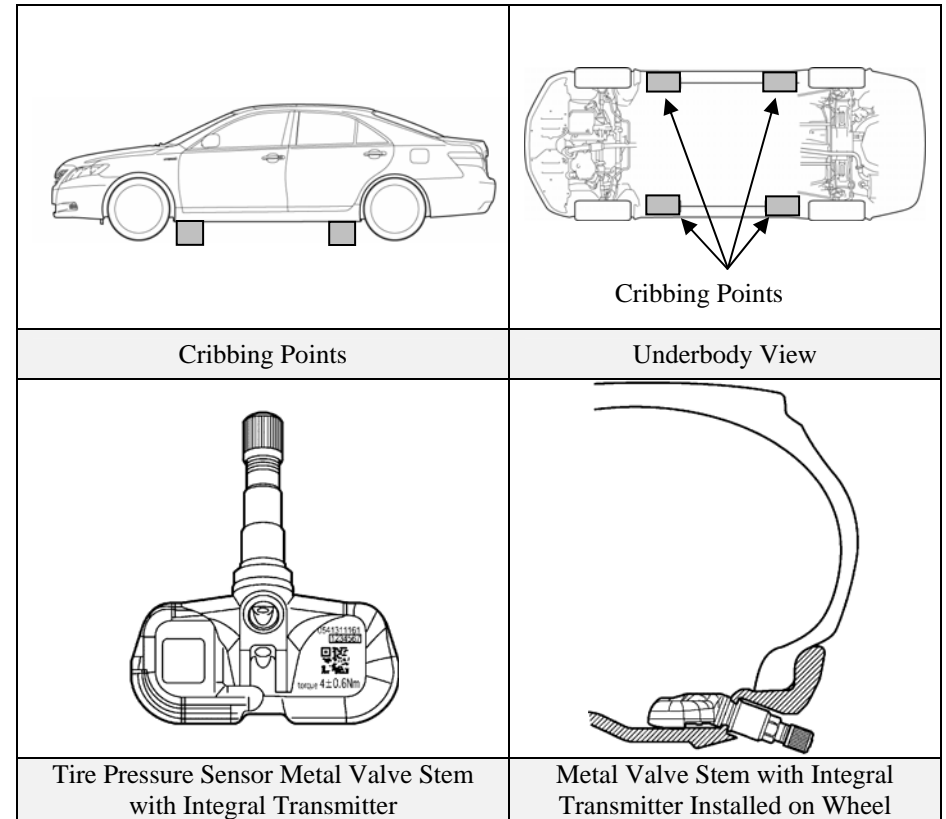



# Emergency Response (Continued)

## Extrication (Continued)

### Roof Removal

The CAMRY hybrid contains side curtain airbags. If undeployed, it is not recommended to remove or to displace the roof. As an alternative, remove the roof panel between the two roof side rails. The side curtain airbags may be identified as illustrated.

### Dash Displacement

The CAMRY hybrid contains side curtain airbags. Do not remove or displace the roof during a dash displacement to avoid cutting into undeployed airbags or inflators. As an alternative, dash displacement may be performed by using a Modified Dash Roll.

### Rescue Lift Air Bags

Responders should not place cribbing or rescue lift air bags under the high voltage power cables, exhaust system, or fuel system.

### Repositioning Steering Wheel and Seats

Manual tilt/telescopic steering wheel and power/manual seat controls are shown in the illustrations. The folding rear seat releases are provided in the trunk.

### NOTE:

The CAMRY driver (optional passenger) power seat and standard passenger manual controls are shown in the illustration. Repositioning the power driver and passenger seats must be done prior to 12 Volt auxiliary battery disconnect.

The Camry hybrid has an electrochromic auto dimming rear view mirror. The mirror contains a minimal amount of transparent gel sealed between two glass plates that will not normally leak.

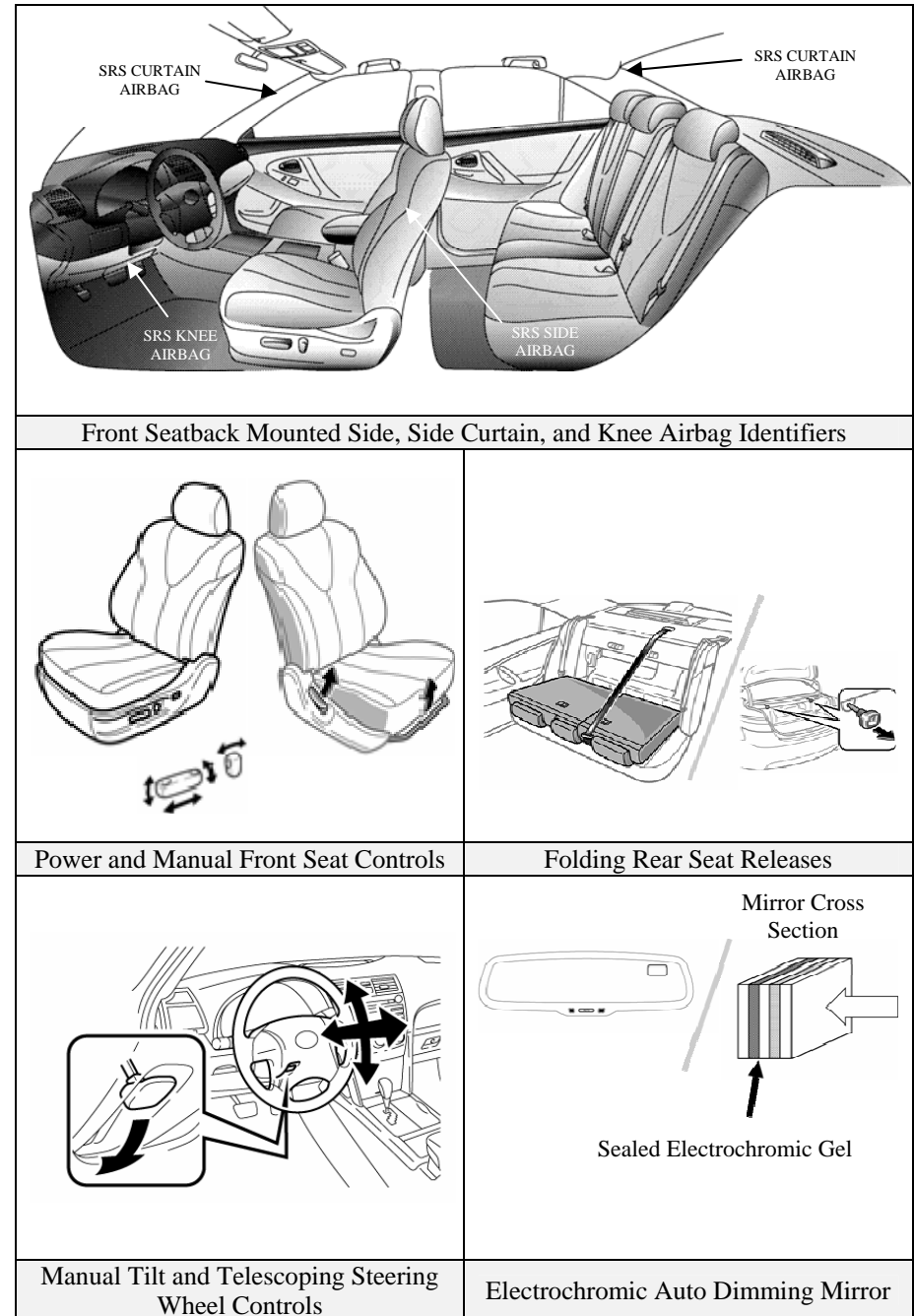

## Emergency Response (Continued)

### Fire

Approach and extinguish a fire using proper vehicle fire fighting practices as recommended by NFPA, IFSTA, or the National Fire Academy (USA).

- Extinguishing Agent  
Water has been proven to be a suitable extinguishing agent.
- Initial Fire Attack  
Perform a fast, aggressive fire attack.  
Divert the runoff from entering watershed areas.  
Attack teams may not be able to identify a CAMRY hybrid until the fire has been knocked down and overhaul operations have commenced.
- Fire in the HV Battery Pack  
Should a fire occur in the NiMH HV battery pack, attack crews should utilize a water stream or fog pattern to extinguish any fire within the trunk *except* for the HV battery pack.

#### **WARNING:**

- *The NiMH battery electrolyte is a caustic alkaline (pH 13.5) that is damaging to human tissues. To avoid injury by coming in contact with the electrolyte, wear proper personal protective equipment.*
- *The battery modules are contained within a metal case and accessibility is limited.*
- *To avoid serious injury or death from severe burns or electric shock, **never** breach or remove the high voltage battery pack cover under any circumstance including fire.*

When allowed to burn themselves out, the CAMRY hybrid NiMH battery modules burn rapidly and can quickly be reduced to ashes except for the metal.

### *Offensive Fire Attack*

*Normally* flooding a NiMH HV battery pack with copious amounts of water at a safe distance will effectively control the HV battery pack fire by cooling the adjacent NiMH battery modules to a point below their ignition temperature. The remaining modules on fire, if not extinguished by the water, will burn themselves out.

However, flooding the CAMRY hybrid HV battery pack is *not* recommended due to the battery case design and location preventing the responder from properly applying water through the available vent openings safely. Therefore, it is recommended that the incident commander allow the CAMRY hybrid HV battery pack to burn itself out.

### *Defensive Fire Attack*

If the decision has been made to fight the fire using a defensive attack, the fire attack crew should pull back a safe distance and allow the NiMH battery modules to burn themselves out. During this defensive operation, fire crews may utilize a water stream or fog pattern to protect exposures or to control the path of smoke.

### *Overhaul*

During overhaul, immobilize and disable the vehicle if not already done. See illustrations on page 17. The HV battery cover should *never* be breached or removed under any circumstances including fire. Doing so may result in severe electrical burns, shock, or electrocution.

- Immobilize Vehicle  
Chock wheels and set the parking brake.  
Move the shift lever to the **P**ark position.
- Disable Vehicle  
Performing either of the following procedures will shut the vehicle off and disable the HV battery pack, SRS, and gasoline fuel pump.



## Emergency Response (Continued)

### Fire (Continued)

#### Procedure #1

1. Confirm the status of **READY** indicator in the instrument cluster.
2. If the **READY** indicator is illuminated, the vehicle is on and operational. Shut off the vehicle by pushing the power button once.
3. The vehicle is already shut off if the instrument cluster lights and the **READY** indicator are not illuminated. Do **not** push the power button because the vehicle may start.
4. Keep the smart key at least 3.3 feet (1 meter) away from the vehicle.
5. If the smart key cannot be found, disconnect the 12 Volt auxiliary battery in the trunk.

#### Procedure #2 (Alternate if power button is inaccessible)

1. Disconnect the 12 Volt auxiliary battery in the trunk.
2. Remove the driver side fuse box cover in the engine compartment.
3. Remove the IGCT No. 2 fuse (10A red colored) in the engine compartment junction block as illustrated on page 18. If the correct fuse cannot be recognized, pull all of the fuses in the fuse block.

### Recovery/Recycling of NiMH HV Battery Pack

Clean up of the HV battery pack can be accomplished by the vehicle recovery crew without further concern of runoff or spillage. For information regarding recycling of the HV battery pack, contact the nearest Toyota dealer or Toyota customer assistance at:

United States: (800) 331-4331    Canada: (888) 869-6828

#### **WARNING:**

- *The high voltage system may remain powered for up to 10 minutes after the vehicle is shut off or disabled. To prevent serious injury or death from severe burns or electric shock, avoid touching, cutting, or breaching any orange high voltage power cable or high voltage component.*
- *The SRS may remain powered for up to 90 seconds after the vehicle is shut off or disabled. To prevent serious injury or death from unintentional SRS deployment, avoid crushing, cutting, or breaching the SRS components.*
- *If none of the disabling procedures can be performed, proceed with caution as there is no assurance that the high voltage electrical system, SRS, or fuel pump are disabled.*

### Spills

The CAMRY hybrid contains the same common automotive fluids used in other non-hybrid Toyota vehicles, with the exception of NiMH electrolyte used in the HV battery pack. The NiMH battery electrolyte is a caustic alkaline (pH 13.5) that is damaging to human tissues. The electrolyte, however, is absorbed in the cell plates and will not normally spill or leak out even if a battery module is cracked. A catastrophic crash that would breach both the metal battery pack case and the plastic battery modules would be a rare occurrence.

Similar to the use of baking soda to neutralize a lead-acid battery electrolyte spill, a dilute boric acid solution or vinegar can be used to neutralize a NiMH battery electrolyte spill.

#### NOTE:

Electrolyte leakage from the HV battery pack is unlikely due to its construction and the amount of available electrolyte contained within the NiMH modules. Any spillage would not warrant a declaration as a hazardous material incident. Responders should follow the recommendations as outlined in this emergency response guide.

## Emergency Response (Continued)

### Spills (Continued)

In an emergency, Toyota Material Safety Data Sheets (MSDS) are available by contacting:

United States: CHEMTREC at (800) 424-9300  
Canada: CANUTEC at \*666 or (613) 996-6666 (collect)

- Handle NiMH electrolyte spills using the following Personal Protective Equipment (PPE):
  - Splash shield or safety goggles. Fold down helmet shields are not acceptable for acid or alkaline electrolyte spills.
  - Rubber, latex or nitrile gloves.
  - Apron suitable for alkaline.
  - Rubber boots.
- Neutralize NiMH Electrolyte
  - Use a boric acid solution or vinegar.
  - Boric acid solution - 800 grams boric acid to 20 liters water or 5.5 ounces boric acid to 1 gallon of water.

### First Aid

Emergency responders may not be familiar with a NiMH electrolyte exposure when rendering aid to a patient. Exposure to the electrolyte is unlikely except in a catastrophic crash or through improper handling. Utilize the following guidelines in the event of exposure.

#### **WARNING:**

*The NIMH battery electrolyte is a caustic alkaline (pH 13.5) that is damaging to human tissues. To avoid injury by coming in contact with the electrolyte, wear proper personal protective equipment.*

- Wear Personal Protective Equipment (PPE):
  - Splash shield or safety goggles. Fold down helmet shields are not acceptable for acid or alkaline electrolyte spills.
  - Rubber, latex or nitrile gloves.
  - Apron suitable for alkaline.
  - Rubber boots.

- Absorption
  - Perform gross decontamination by removing affected clothing and properly disposing of the garments.
  - Rinse the affected areas with water for 20 minutes.
  - Transport patients to the nearest emergency medical care facility.
- Inhalation in Non-Fire Situations
  - No toxic gases are emitted under normal conditions.
- Inhalation in Fire Situations
  - Toxic gases are given off as by-products of combustion. All responders in the Hot Zone should wear the proper PPE for fire fighting including SCBA.
  - Move a patient from the hazardous environment to a safe area and administer oxygen.
  - Transport patients to the nearest emergency medical care facility.
- Ingestion
  - Do not induce vomiting.
  - Allow a patient to drink large quantities of water to dilute electrolyte (Never give water to an unconscious person).
  - If vomiting occurs spontaneously, keep the patient's head lowered and forward to reduce the risk of asphyxiation.
  - Transport patients to the nearest emergency medical care facility.

### Submersion

When fully or partially submersed a CAMRY hybrid can be safely handled by following these recommendations:

- Remove the vehicle from the water.
- Drain the water from the vehicle if possible.
- Follow the immobilizing and disabling procedures on page 17.

## Roadside Assistance

Toyota CAMRY hybrid roadside assistance may be handled like conventional Toyota vehicles except as noted in the following pages.

### Shift Lever

Similar to most Toyota vehicles, the CAMRY hybrid uses a gated shift lever as shown in the illustration. However, the CAMRY hybrid shift lever includes a motor brake **B** position for high load regenerative braking when decelerating down a steep grade.

### Towing

The CAMRY hybrid is a front drive vehicle and it must be towed with the front wheels off the ground. Failure to do so may cause serious damage to the *Hybrid Synergy Drive* components.

- A flat bed trailer is the preferred method of towing.
- When towing the vehicle with the front wheels on the ground, be sure to release the parking brake pedal.
- If a tow truck is not available in an emergency, the vehicle may be temporarily towed using a cable or chain secured to the emergency towing eyelet. This should only be attempted on hard, paved roads for short distances at low speeds.
- The vehicle may be shifted out of **Park** into Neutral by turning the ignition-on, depressing the brake, then moving the gated shift lever to **N**.
- If the shift lever can not be moved out of **Park**, a shift release button is provided near the shift lever as shown in the illustration.

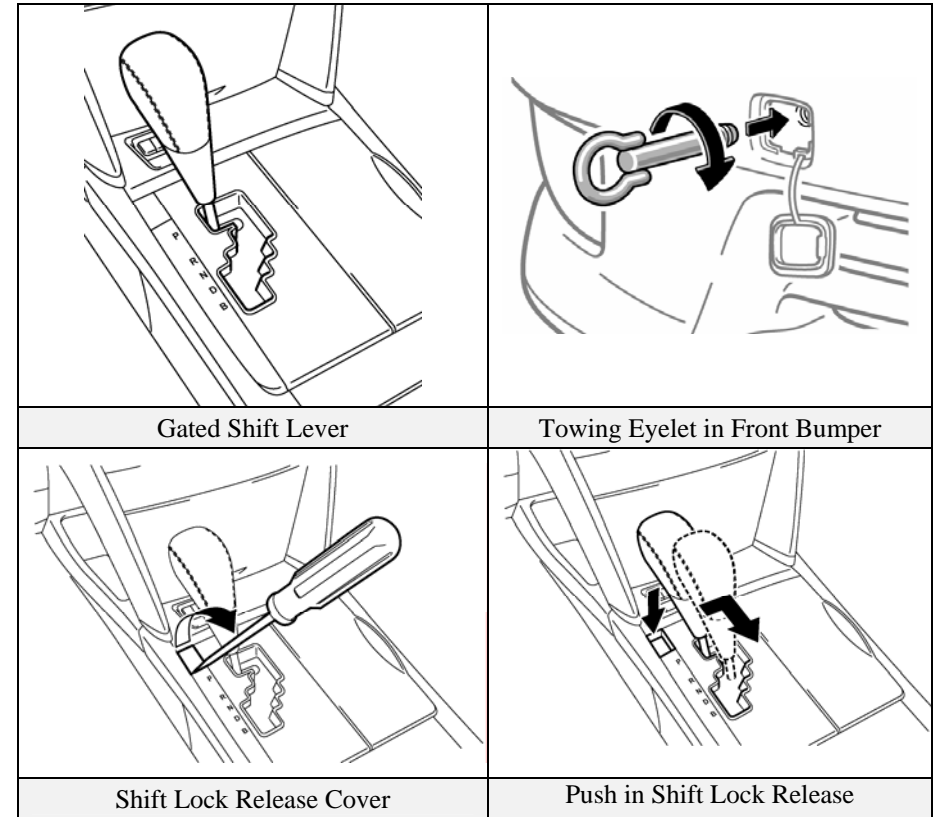

## Roadside Assistance (Continued)

### Electric Fuel Door Opener

The CAMRY hybrid is equipped with an electric fuel door opener. In the event of 12 Volt power loss, the fuel door can only be opened using the manual release located inside the trunk.

### Spare Tire

The jack, tools, towing eyelet, and spare tire are provided in the trunk as illustrated.

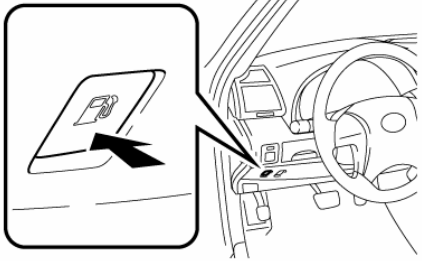
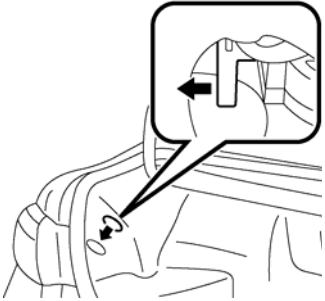
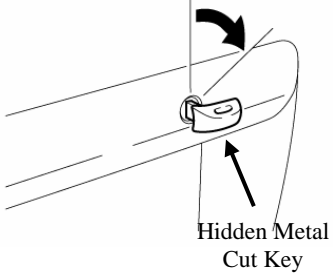
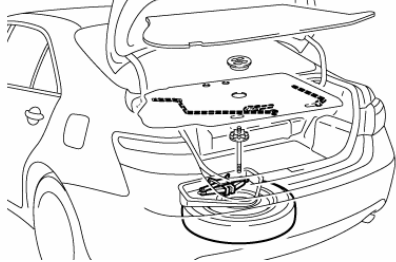
	
Fuel Door Opener Switch	Manual Fuel Door Release
 <p>Hidden Metal Cut Key</p>	
Manual Trunk Opening with the Metal Cut Key	Tools, Towing Eyelet, and Spare Tire in the Trunk

## Roadside Assistance (Continued)

### Jump Starting

The 12 Volt auxiliary battery may be jump started if the vehicle does not start and the instrument cluster gauges are dim or off after depressing the brake pedal and pushing the power button.

The 12 Volt auxiliary battery is located in the trunk. Use the remote trunk release or metal cut key hidden in the smart key to open the trunk.

- Open the trunk, and remove the 12 Volt auxiliary battery cover on the passenger side.
- Connect the positive jumper cable to the positive battery post following the numbered sequence.
- Connect the negative jumper cable to the metal trunk latch following the numbered sequence.
- Place the smart key in proximity to the vehicle, depress the brake pedal, and push the power button.

#### NOTES:

If the vehicle does not recognize the smart key after connecting the booster battery to the vehicle, open and close the driver door when the vehicle is shut off.

If the smart key internal battery is dead, hold the smart key next to the power button during the start sequence.

The high voltage HV battery pack cannot be jump started.

### Immobilizer

The Camry hybrid is equipped with an immobilizer system as standard equipment. The vehicle can be started only with a registered smart key.

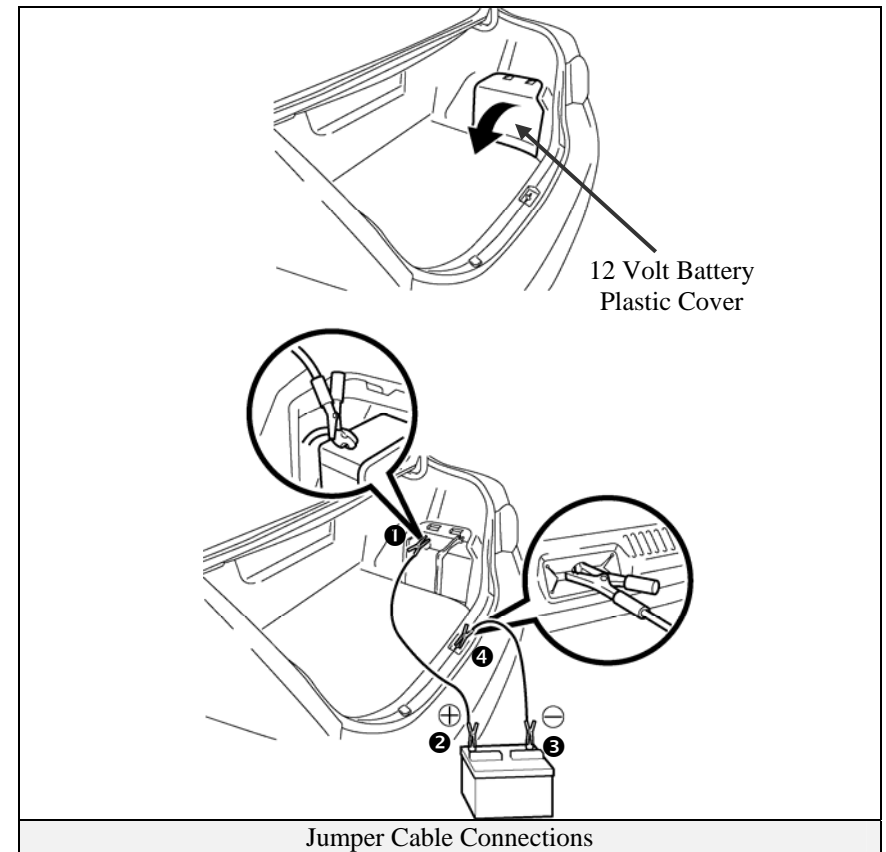

Jumper Cable Connections