

# INFORMATION FOR FIRST AND SECOND RESPONDERS

## EMERGENCY RESPONSE GUIDE

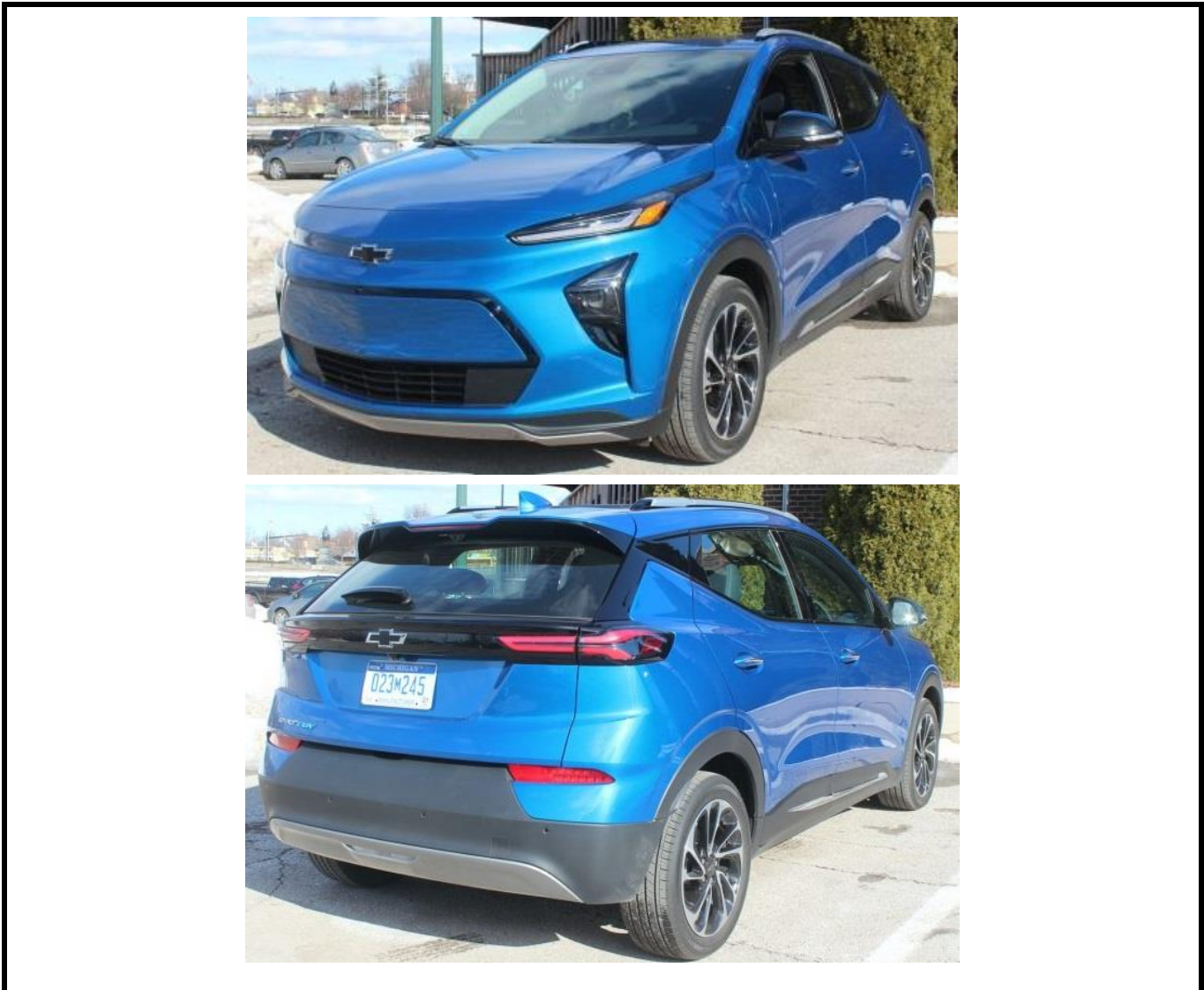

**Chevrolet Bolt EUV**  
**Passenger Car**  
Li-ion Battery

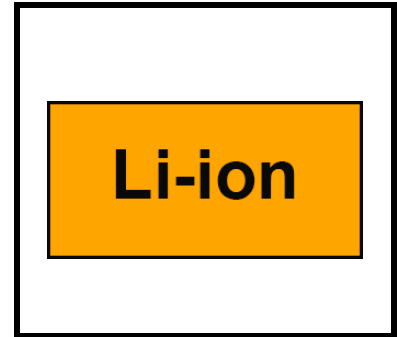

# CONTENTS

1. Identification / recognition	Page	3
2. Immobilization / stabilization / lifting	Page	4
3. Disable direct hazards / safety regulations	Page	5
4. Access to the occupants	Page	8
5. Stored energy / liquids / gases / solids	Page	12
6. In case of fire	Page	13
7. In case of submersion	Page	13
8. Towing / transportation / storage	Page	14
9. Important additional information	Page	14
10. Explanation of pictograms used	Page	15

## 1. Identification / recognition



Advise Dispatch and all responders that an electric vehicle is involved.



Lack of engine noise does not mean vehicle is off: vehicle movement capability exists until vehicle is fully shut down. Always wear appropriate protective equipment (Insulated Gloves, Safety Goggles).

### Emblems and Badging



The BOLT EUV can be identified by those emblems that appear on the front fender upper applique and the liftgate of the vehicle.



### High Voltage Battery Information

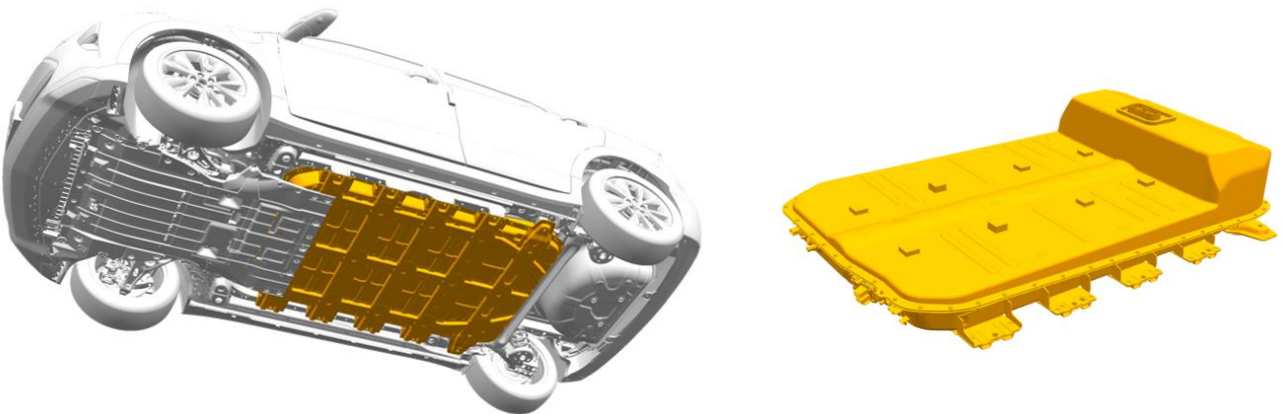

The battery is a high voltage lithium ion pack mounted under the vehicle.



## First Responder Information Label

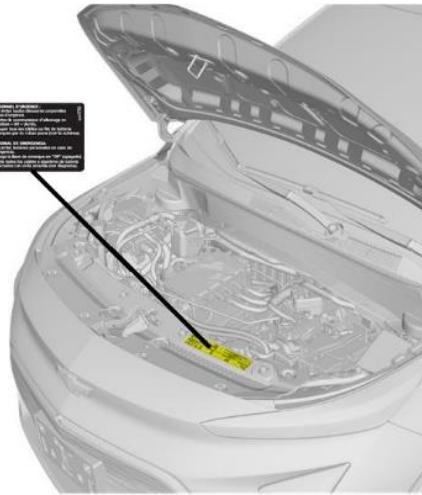

The battery warning label is located on the front compartment sight shield, on the left front side of the vehicle, under the hood.

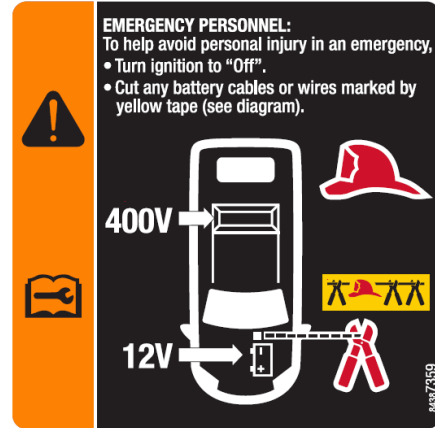

## 2. Immobilization / stabilization / lifting



### IMMOBILIZE VEHICLE

- Block the wheels.
- Pull the Electric Parking Brake (EPB) switch.
- Press the P (Park) button.

### Electric Parking Brake (EPB)

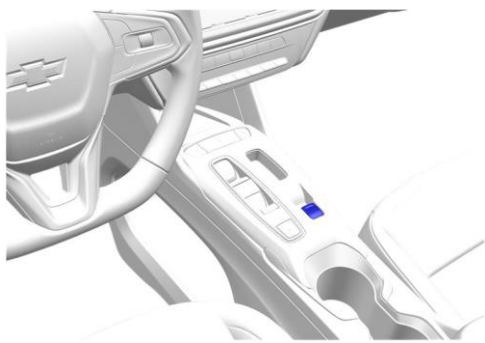

#### Applying the Electric Parking Brake

Pull the EPB switch momentarily. The red parking brake status light will flash and then stay on once the EPB is fully applied.

#### Releasing the Electric Parking Brake

1. Turn the ignition on or to ACC/ACCESSORY.
2. Apply and hold the brake pedal.
3. Press the EPB switch momentarily.

The EPB is released when the red parking brake status light is off.

## Electric Drive Unit Shift Lever

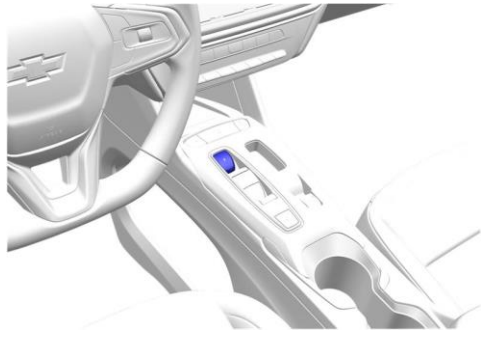

### Shifting into Park

When the vehicle is stopped, press the P (Park) button.



### Power Button

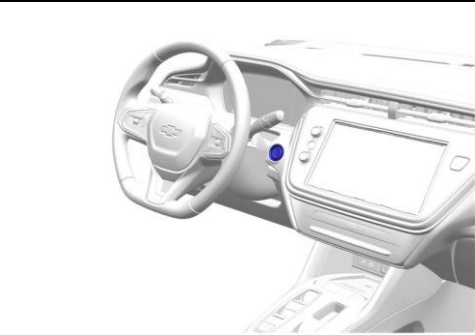

To turn the vehicle off, apply the brakes, press the P (Park) switch on the center console and press POWER button.

Alternatively, apply the brakes and press POWER button. The electric drive unit will shift to P (Park) then shut off automatically.



### Lifting Points

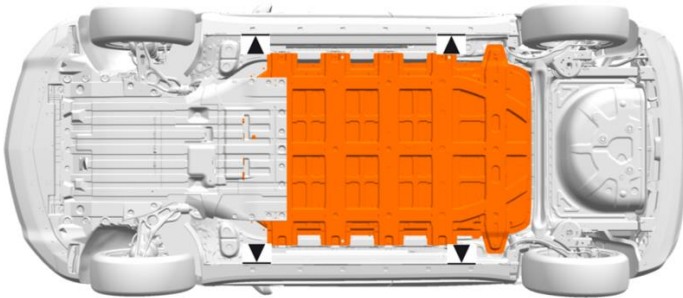

Indicates primary lifting locations.

## 3. Disable direct hazards / safety regulations

### MAIN METHOD:

1. Before working on any high voltage system, be sure to wear appropriate protective equipment.
2. If necessary, terminate charging and disconnect the charge cable from the vehicle.
3. Press the POWER button to disable vehicle propulsion.
4. Remove the keys from the vehicle.
5. Open the hood.
6. Cut the low voltage cable marked by the yellow tape.
7. If possible, disconnect the high voltage battery manual disconnect lever assembly.



After disabling 12-volt power, wait at least 10 seconds to allow any un-deployed airbag reserve energy to dissipate, and wait at least 1 minute to allow high voltage energy to discharge.

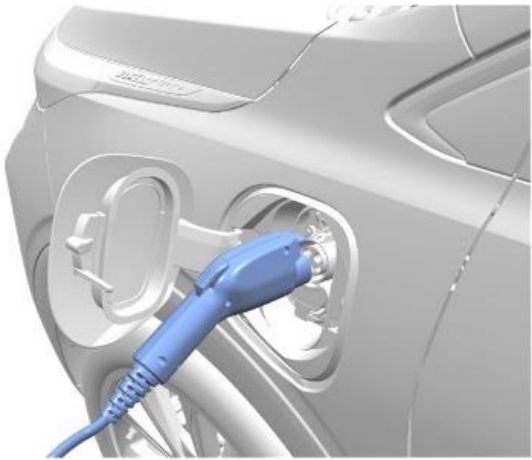

**VEHICLE AT CHARGE STATION:**

If able, terminate charging by removing the charge handle from the vehicle. If enabled, the vehicle's anti-theft alarm may activate.

Level 2 charge handle is shown; Level 3 (DC Fast Charge) handle is moderately larger and may require additional effort to disconnect.



**Power Button**



To turn the vehicle off, apply the brakes, press the P (Park) switch on the center console and press POWER button.

Alternatively, apply the brakes and press POWER button. The electric drive unit will shift to P (Park) then shut off automatically.



The high voltage system can remain energized even when the vehicle is in the OFF state.



**Inside Access to Hood Release**

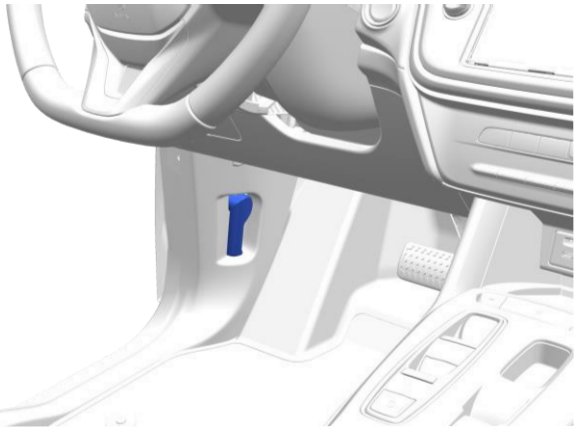

**Manual Operation**

Pull the hood release cable to release the hood. It is on the lower left side of the instrument panel.



### Low Voltage Cable Access

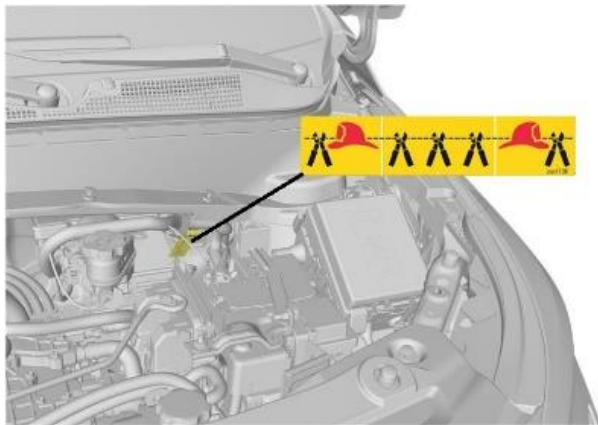

#### Low Voltage Cable

Cut the low voltage cables marked by the yellow tape located above the battery on the left side of the forward compartment.

This cut will disable the airbags and high voltage.

**DO NOT CUT ANY ORANGE COLORED HIGH VOLTAGE CABLES.**

**Important:** Cut through the harness on each side of the tag to remove a section of the cable. This ensures that the cable ends cannot reconnect inadvertently.



### High Voltage Disconnect

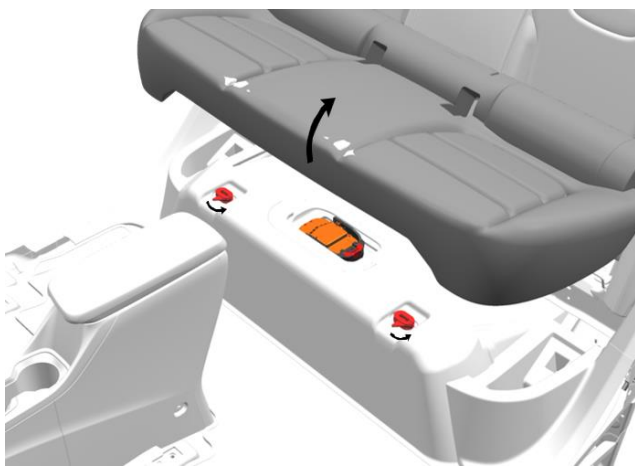

#### Rear Seat Cushion Removal

Release 2 rear seat cushion clips and lift the rear seat cushion.

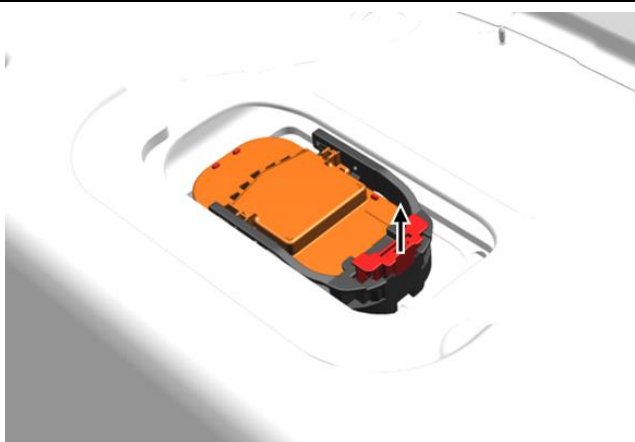

#### High Voltage Battery Manual Disconnect Lever

Lift the connector position assurance retainer.

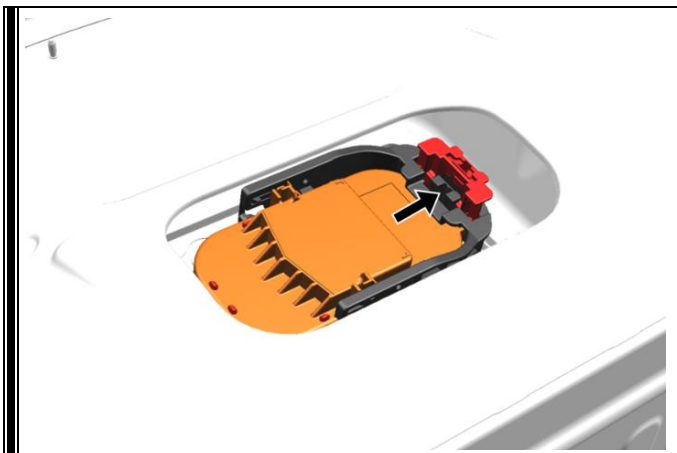
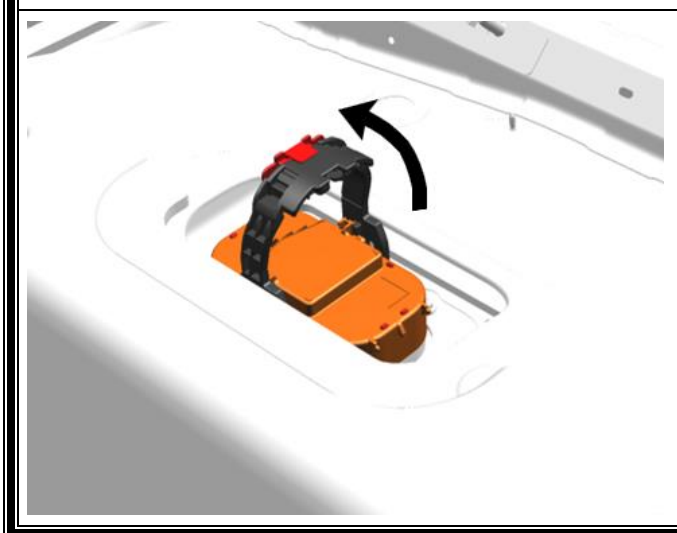
	<p>Push the lever button and then rotate the connector lever.</p>
	<p>Remove the high voltage battery manual disconnect lever assembly from the vehicle.</p>

<p><b>4. Access to the occupants</b></p>	
	<p><b>Opening a Locked Door</b></p> <p>If the doors remain locked, pull <b>twice</b> on the inside door handle to gain access to the occupant at each seating location.</p>



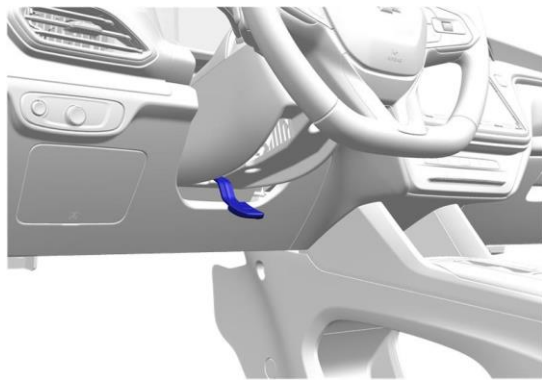

### Steering Column Adjustment

Pull the lever down to move the steering column.  
Pull the lever up to lock the steering column in place.



### Seat Adjustment (Electrical) – Driver Seat

#### Front Switch

Move the seat forward or rearward by sliding the control forward or rearward.  
Raise or lower the seat by moving the control up or down.

#### Middle Switch

Rotate the switch forward to raise the seatback and rearward to recline the seatback.



### Seat Adjustment (Manual) – Passenger Seat

#### Seat Position

Pull the handle at the front of the seat to slide the seat.

#### Reclining Seatback

Lift the lever at the right side of the seat to move the seatback.

### Vehicle Glass

 - The windshield and the roof panels are made of Laminated Glass

 - The door windows and rear window are made of Tempered Glass



## High Strength Steel Structure

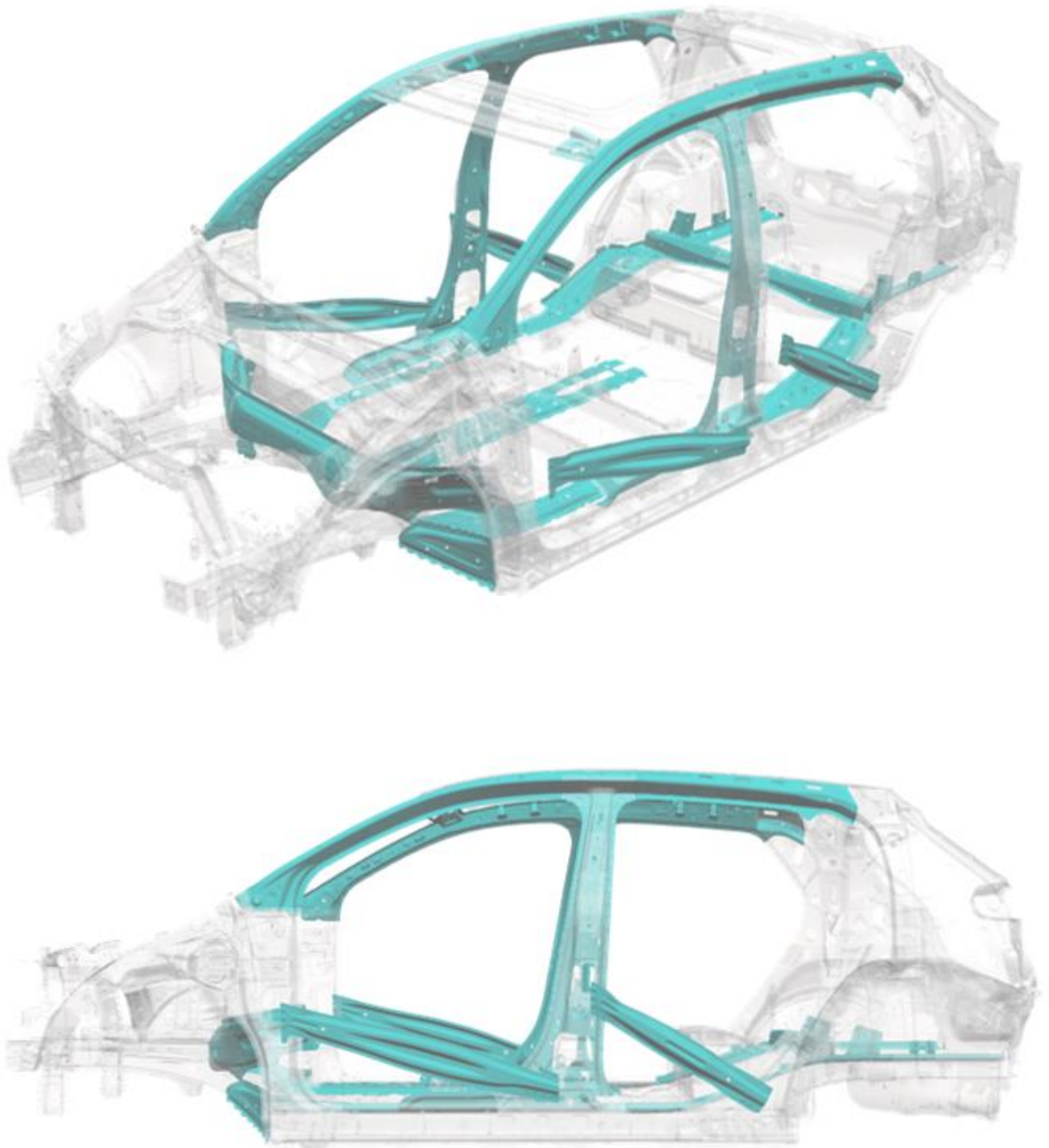

The passenger compartment is protected using high strength steel in the pillars, rocker panels, door reinforcement beams, and floor structure.

## Door Hinges and Strikers

Refer to the location of the door hinges and the strikers on the side doors.

**WARNING:** Do NOT cut into the vehicle until the 12V electrical system has been disabled. Cutting into the vehicle prior to disconnecting and isolating the 12V electrical energy sources may cause air bag deployment resulting in serious injury.

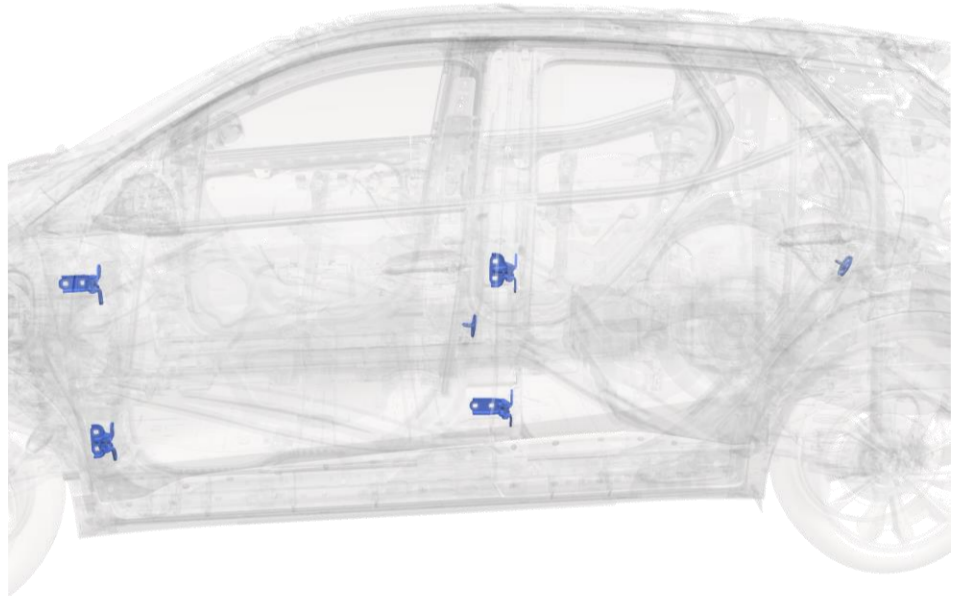

## Occupant Restraint Systems

BOLT EUV is equipped with 10 Airbags:

- Driver
- Front Seat Passenger
- (2) Front Seat Side Airbags
- (2) Rear Seat Side Airbags
- (2) Roof Rail Airbags
- (2) Knee Airbags

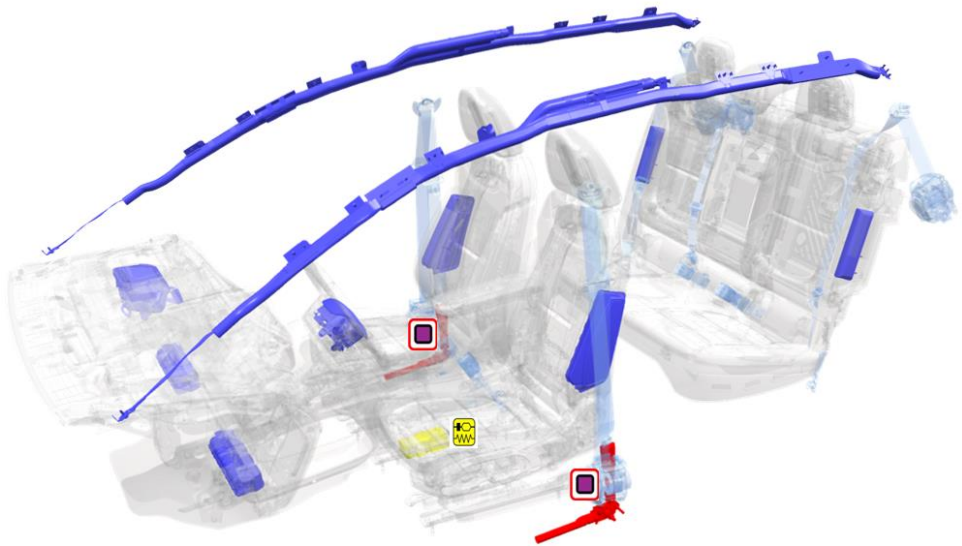

There are seat belt restraints for five occupants.

The front seat belt system includes retractor-mounted pre-tensioners.

## Do Not Cut High Voltage Cables

**DANGER:** Do NOT cut the orange high voltage cables. Cutting these cables can result in serious injury or death. No matter which disable method you perform, always assume the high voltage cables and components contain high voltage.

The high voltage cables are highly protected and should not interfere with any extraction procedures. However, always perform the disabling procedure to eliminate electrical current flow through the 12 volt system, and disable the high voltage electrical system before any other work.

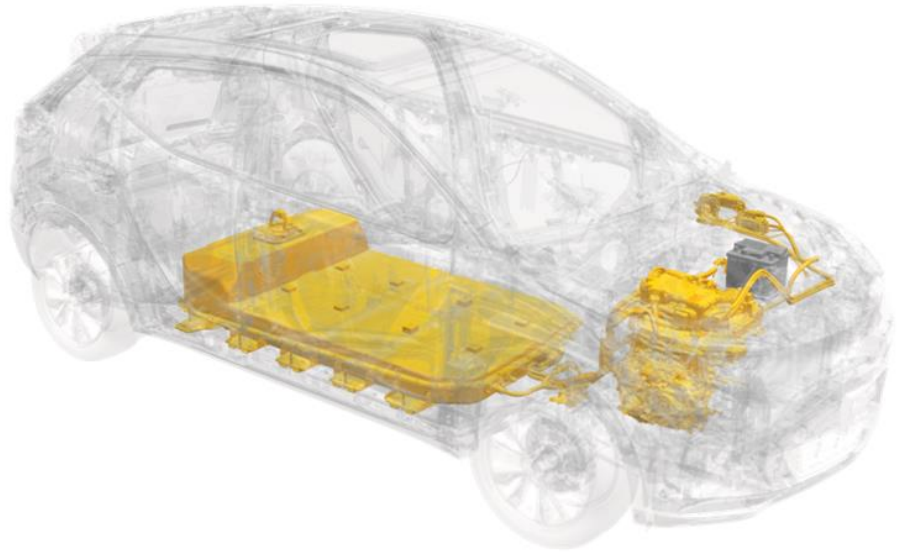







## 5. Stored energy / liquids / gases / solids

<b>Li-ion</b>	High Voltage Lithium Ion Chemistry Battery
	High Voltage Warning, potential for electric shock
	Gases emitted from the battery pack are flammable
	Gases emitted from the battery pack are toxic
	Skin contact may cause irritation. Prolonged contact with electrolyte mixture may result in more severe irritation. Flush contaminated skin with plenty of water.



**Coolant leaking inside the battery pack can become unstable and possibly a risk for a fire. Check the battery pack temperature using a thermal imaging camera.**

## 6. In case of fire

	High Voltage Warning, potential for electric shock
	A battery on fire will not explode.
	A battery on fire will not explode. If battery cells reach high enough temperature, they vent and release electrolyte. Battery electrolyte is flammable.
	Gases emitted from the battery pack are toxic
	Skin contact may cause irritation. Prolonged contact with electrolyte mixture may result in more severe irritation. Flush contaminated skin with plenty of water.
	Potential for eye, nose, and throat irritation with prolonged exposure.
	Use copious amounts of water to cool the battery and to extinguish a fire. Do not use an ABC dry chemical extinguisher because it will not extinguish a battery fire.



**Potential for Battery Re-Ignition.**

## 7. In case of submersion

The high voltage battery is isolated from the vehicle chassis. If the vehicle is immersed in water, you will not be electrocuted by touching the vehicle.

After the vehicle was removed from the water, do the following:

1. Allow the vehicle to dry out.
2. Perform the high voltage disabling procedure in Section 3.

## 8. Towing / transportation / storage

### Tow Hooks



The vehicle is equipped with front and rear tow hooks used to pull the vehicle onto a flatbed carrier from a flat road surface.

### Vehicle Towing and Transportation

GM recommends a flatbed carrier to transport a disabled vehicle.

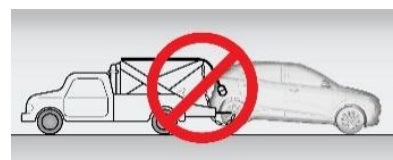
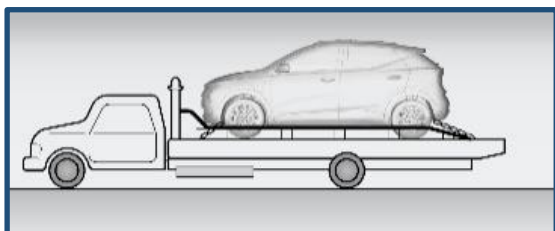

### Post-Crash Vehicle Storage

Store the vehicle a safe distance/separated from other vehicles.

















**Potential for continued hazards (rekindling/re-gassing/etc) if a damaged vehicle battery is jostled during recovery, including the towing and storage process.**

## 9. Important additional information

This vehicle is supported by OnStar, where available.

### 10. Explanation of pictograms used

	<b>Electric Vehicle</b>		<b>General warning sign</b>		<b>Warning, Electricity</b>
	<b>Battery Technology</b>		<b>Lifting Points</b>		<b>Thermal Imaging Camera</b>
	<b>Flammable</b>		<b>Toxic</b>		<b>Corrosive</b>
	<b>Injury Risk</b>		<b>Use Water</b>		<b>Front Compartment Release</b>
	<b>Power Button</b>		<b>Cable Cut Location</b>		