



PORSCHE

Porsche Model Overview

Model	Model Year	Model	Model Year
9PA:		997:	
Cayenne/S/Turbo	from 2003	911 Coupé models:	from 2005
Cayenne/S/GTS/Turbo/Turbo S/Diesel	from 2006	Carrera/S/4/4S/GTS/4 GTS	
92A:		911 Cabrio models:	from 2005
Cayenne/S/GTS/Turbo/Diesel/S Diesel/Turbo S	from 2011	Carrera/S/4/4S/GTS/4 GTS/Speedster	
Cayenne S Hybrid	from 2011	911 Targa 4/4S	from 2007
Cayenne/S/GTS/Turbo/Diesel/S Diesel/Turbo S	from 2015	911 Coupé models: Turbo/S	from 2007
Cayenne S E-Hybrid	from 2015	911 Cabrio models: Turbo/S	from 2008
9AY:		911 GT3	from 2007
Cayenne all derivatives (excl. E-Hybrid)	from 2017	911 GT3 RS	from 2007
Cayenne E-Hybrid all derivatives	from 2018	911 GT2	from 2008
987:		911 GT2 RS	from 2011
Boxster/S/Spyder	from 2005	970:	
Cayman/S/R	from 2006	Panamera/S/4/4S/GTS/Turbo/Diesel/Turbo S (incl. Executive models)	from 2010
991:		Panamera S Hybrid	from 2011
911 Coupé models:	from 2012	Panamera S E-Hybrid	from 2014
Carrera/S/4/4S/GTS/4 GTS/Turbo/Turbo S		971:	
911 Cabrio models:	from 2012	Panamera, all derivatives (excl. E-Hybrid)	from 2016
Carrera/S/4/4S/GTS/4 GTS/Turbo/Turbo S		Panamera E-Hybrid, all derivatives	from 2016
911 GT3/RS	from 2014	974:	
911 Targa 4/4S/GTS	from 2014	Panamera Sport Turismo, all derivatives (excl. E-Hybrid)	from 2017
911 R	from 2016	Panamera Sport Turismo E-Hybrid, all derivatives	from 2017
911 GT2 RS	from 2017	981:	
911 Speedster	from 2019	Boxster/S/GTS	from 2012
992:		Cayman/S/GTS/GT4	from 2014
911 Coupé all derivatives	from 2019	Boxster Spyder	from 2015
911 Cabrio, all derivatives	from 2019	982:	
95B:		718 Cayman GT4	from 2019
Macan/S/GTS/S Diesel/Turbo	from 2014	718 Spyder	from 2019
918 Spyder:		718:	
918 Spyder	from 2014	Boxster/S	from 2016
		Cayman/S	from 2016
		Y1A	
		Taycan Saloon	from 2020



PORSCHE

Legal notice:

Porsche emergency information sheets have been produced exclusively for emergency services with relevant professional training in assisting people following accidents, and they must be used only for that purpose.

The information they provide includes details of vehicle construction, passive safety systems and alternative drive systems, and a description of the various available equipment options.

Porsche does not claim to have expertise regarding emergency operations. All emergency services must therefore assess this information before using it in an emergency situation and develop strategies and decisions based on their specialist knowledge. We recommend that all emergency services examine representative Porsche vehicles in order to fully understand this information.

This document, including its parts, is protected by copyright. Any commercial use or application requires prior written approval from Porsche AG. This applies in particular to duplication, processing, revision, translation, microfilming and saving and/or processing on electronic systems, including databases and online services.









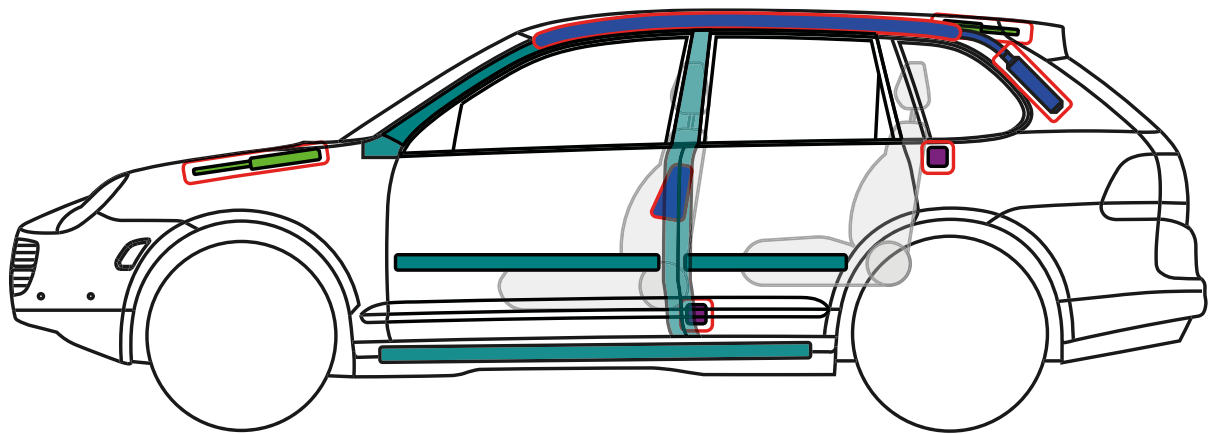
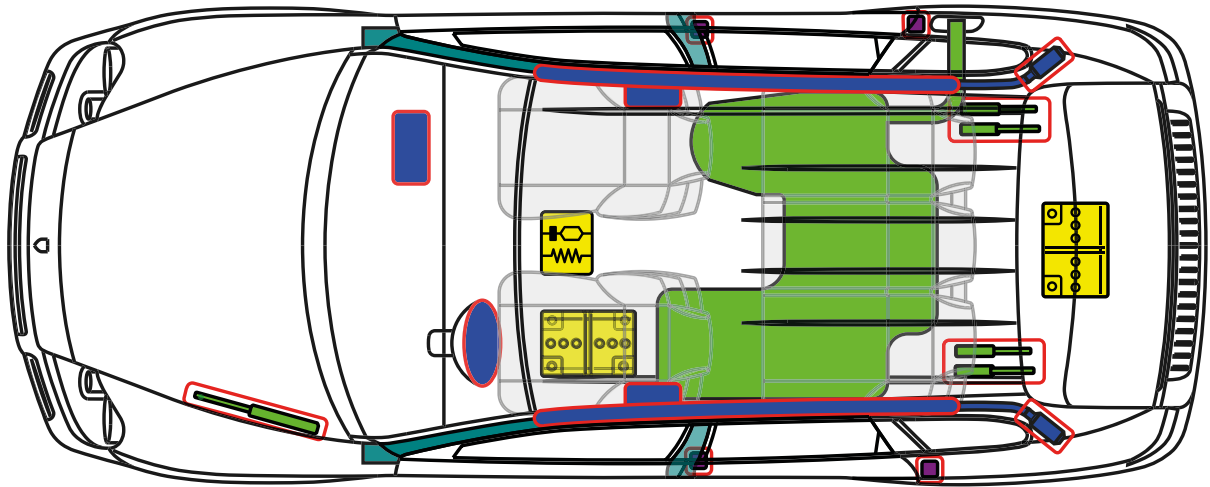





Porsche AG expressly reserves the right to make adjustments or amendments at any time. The information is correct at the time of going to print. Porsche does not accept any obligation to update, amend or replace this information.



**Porsche AG, Cayenne/S/Turbo (9PA)
SUV
Model Year 2003 to Model Year 2005**

PORSCHE



	Airbag		Body reinforcement		SRS-Control unit		High voltage battery
	Gas generator		Gas strut		12-volt Battery		High voltage cable / component
	Seat belt pretensioner		Pedestrian protection system		Fuse box		High voltage cut-off
	Fuel tank		Roll-over protection		Condenser		









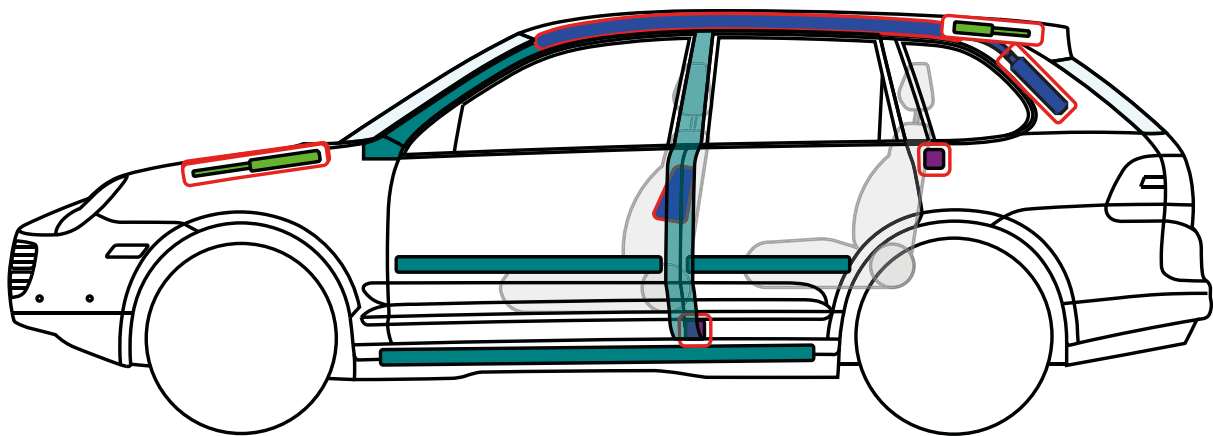
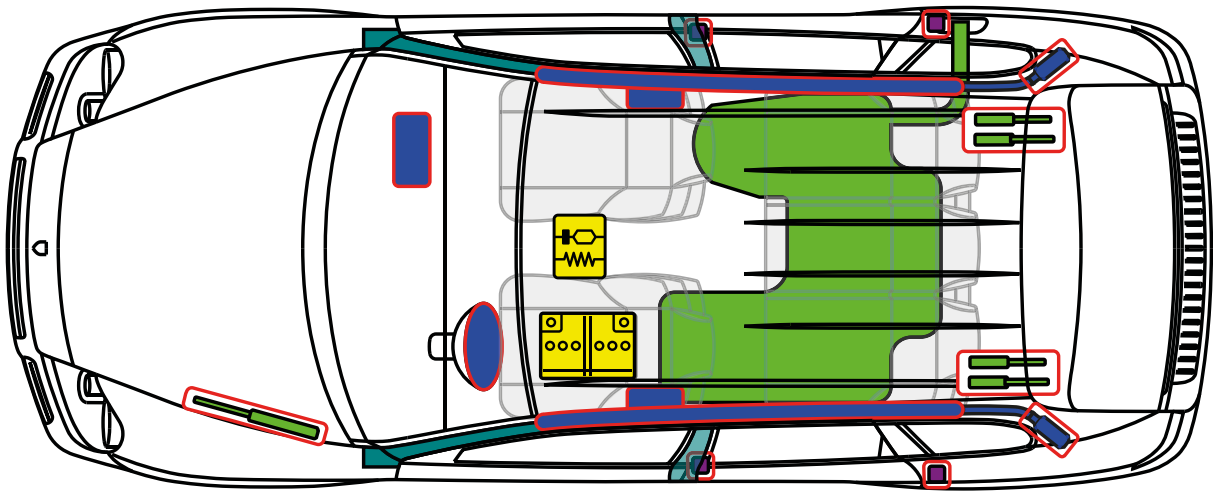







Porsche AG, Cayenne/S/GTS/Turbo/Turbo S/Diesel (9PA) SUV

Model Year 2006 to Model Year 2010

PORSCHE



	Airbag		Body reinforcement		SRS-Control unit		High voltage battery
	Gas generator		Gas strut		12-volt Battery		High voltage cable / component
	Seat belt pretensioner		Pedestrian protection system		Fuse box		High voltage cut-off
	Fuel tank		Roll-over protection		Condenser		



**Porsche AG, Cayenne/S/GTS/Turbo/Diesel/
S Diesel/ Turbo S (92A) SUV
from Model Year 2011**

PORSCHE

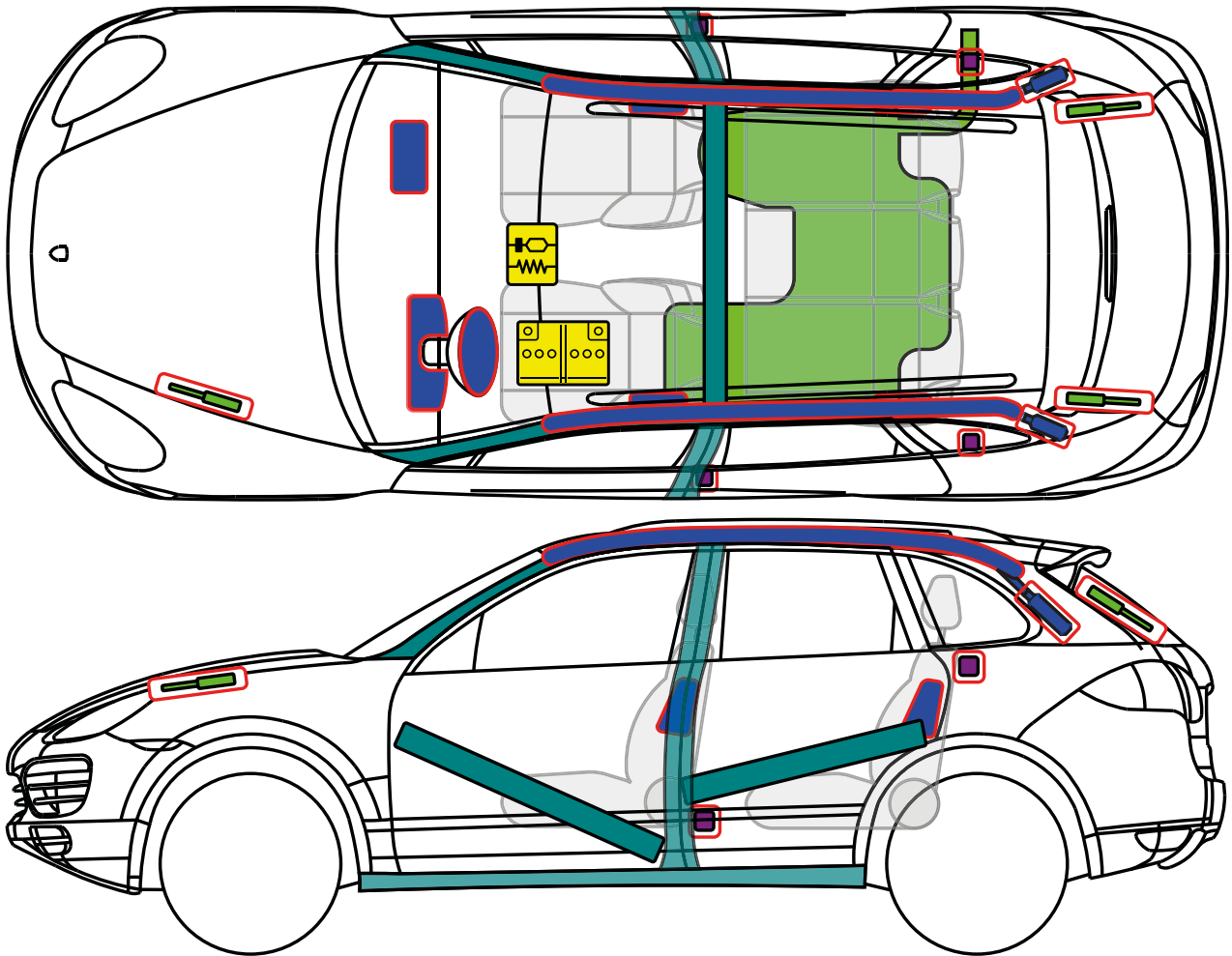

	Airbag		Body reinforcement		SRS-Control unit		High voltage battery
	Gas generator		Gas strut		12-volt Battery		High voltage cable / component
	Seat belt pretensioner		Pedestrian protection system		Fuse box		High voltage cut-off
	Fuel tank		Roll-over protection		Condenser		



**Porsche AG, Cayenne S Hybrid (92A)
SUV
from Model Year 2011**

PORSCHE

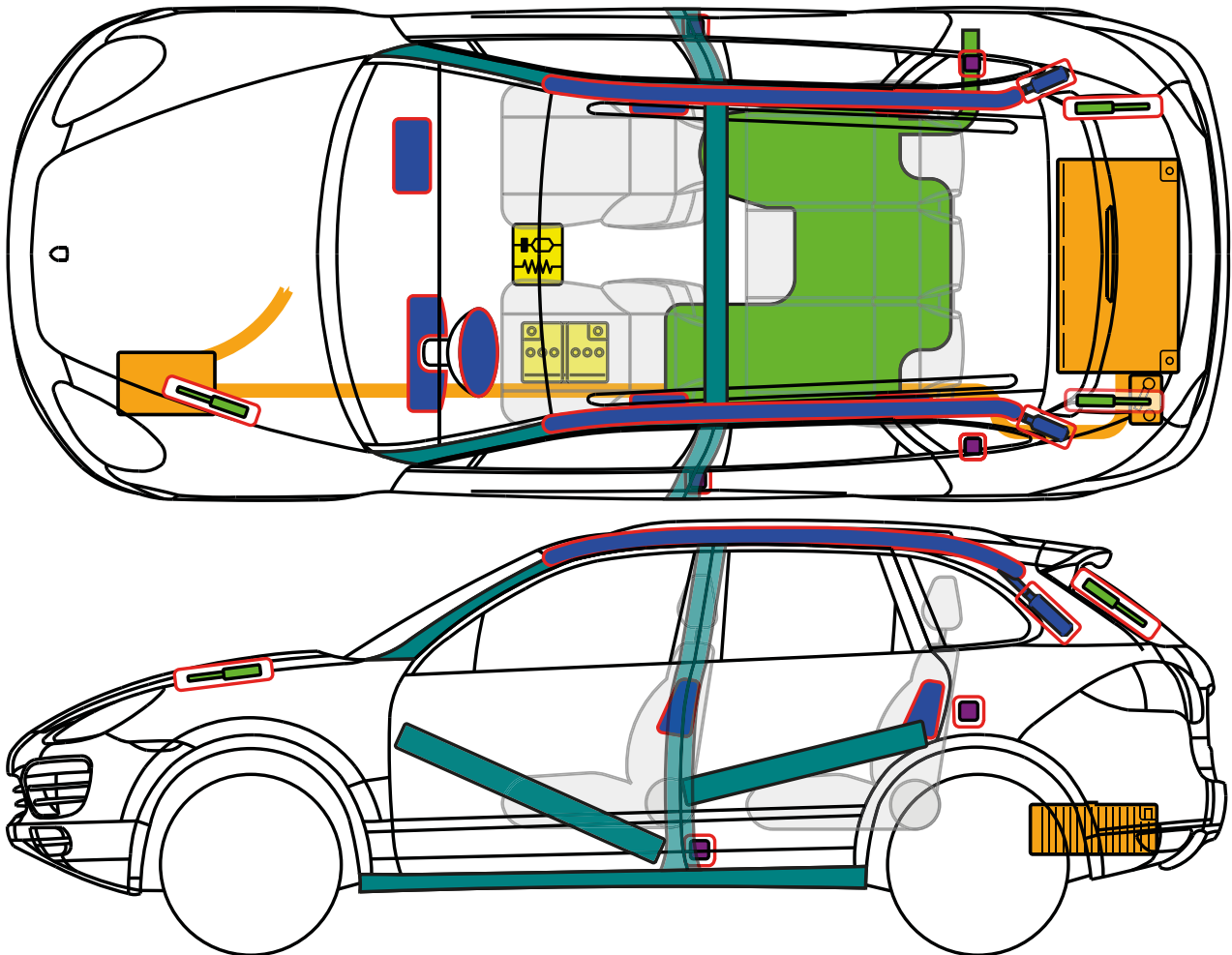

	Airbag		Body reinforcement		SRS-Control unit		High voltage battery
	Gas generator		Gas strut		12-volt Battery		High voltage cable / component
	Seat belt pretensioner		Pedestrian protection system		Fuse box		High voltage cut-off
	Fuel tank		Roll-over protection		Condenser		

Vehicle identification and marking

Cayenne S Hybrid identification features



"Hybrid" logo on the engine cover

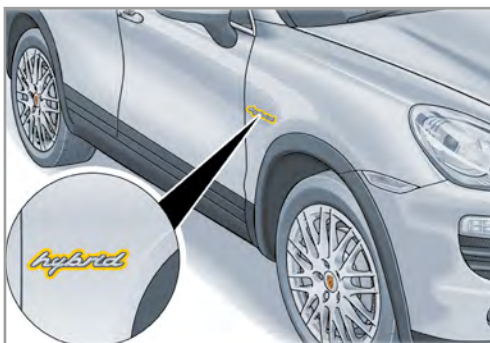

"Hybrid" logo on the left and right fenders

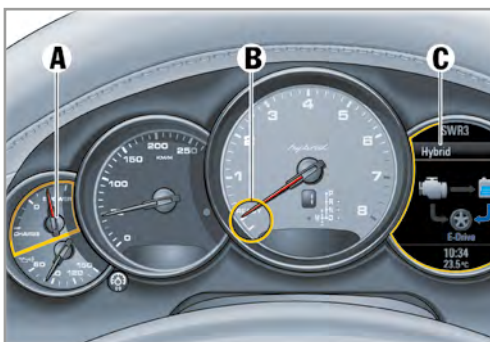

On the **instrument cluster**

A = E-Power meter,
B = READY indicator,
C = energy flow in the multifunction display

Marking of the hybrid components



All high-voltage components are clearly marked with warning labels.



Warning on the lockable plastic cover in the engine compartment.

All high-voltage cables have orange insulation.

Safety information about the hybrid system

Undamaged plugs, cables and sockets in the on-board high-voltage system are safe to touch.

DANGER

Risk of serious or fatal injury from electric shock if handled incorrectly!

If high-voltage components are not handled correctly, there is a risk of fatal injury.

- Do not touch high-voltage components that are in operation.
- Do not damage the orange high-voltage cables in the on-board high-voltage system.
- There may still be voltage in the high-voltage battery even after the on-board high-voltage system has been switched off. The high-voltage battery must not be damaged or opened.

Switching off the passive safety system and high-voltage system

WARNING

The electric motor is silent when stationary!

You cannot always tell from the operating noise whether the car is ready to start because the electric motor is silent when stationary.

- The vehicle may be ready to start even when no engine noises can be heard.
- The combustion engine may start automatically when the transmission is in “P” or “N” depending on the level of charge of the high-voltage battery.

NOTE

In the event of an accident where the airbags and seat belt pre-tensioners are activated

The high-voltage system switches off automatically in accidents where the airbags and seat belt pre-tensioners are activated.

NOTE

In the event of an accident where the airbags and seat belt pre-tensioners are not activated

The following steps should be taken to make sure that the engine and safety systems are switched off:

1. Switch ignition key to “OFF”.
2. Disconnect the 12-volt battery beneath the driver’s seat.

If neither the ignition nor the 12-volt battery is accessible:

1. Unplug the 12-volt connector in the luggage compartment.

Other deactivation methods as described in the manual (e.g. pulling out the service plug) may only be performed by appropriately qualified personnel.

Switching off the ignition

The method of switching off the high-voltage system described below applies to both vehicles with a conventional key and those with Porsche Entry & Drive.

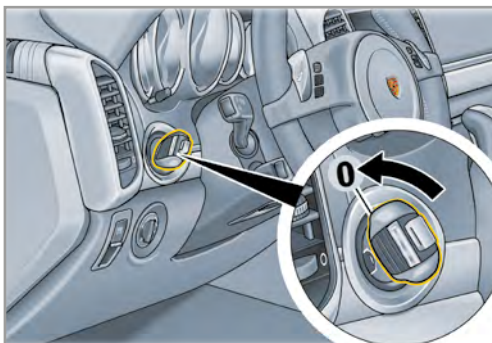

1. Turn the ignition key to “OFF” (0 position).

- There is no voltage in the high-voltage system once it has been switched off.
- The passive safety systems, such as airbags and seat belt pre-tensioners, are still supplied with voltage from the on-board 12-volt battery.

Disconnecting the 12-volt battery

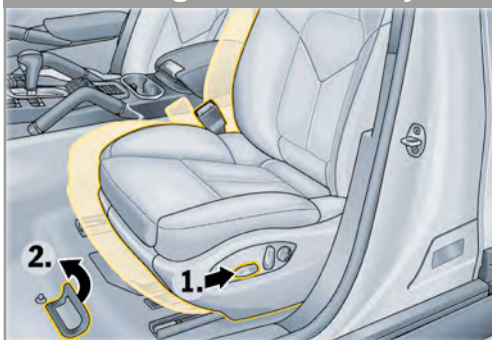

1. If possible, move the driver's seat back to the furthest position (-1-).
2. Remove the section of carpet (-2-).

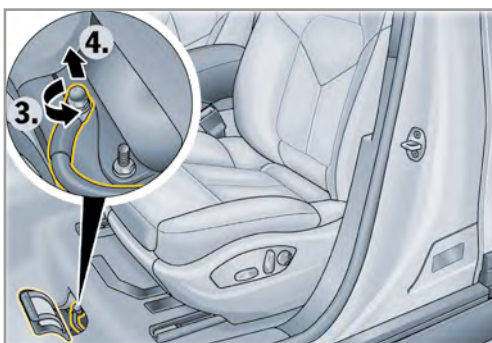

3. Disconnect the 12-volt battery's ground cable from the screw terminal (-3-).

- The passive safety systems (airbags and belt tensioners) are deactivated.

No access to the ignition or 12-volt battery

Unplugging the 12-volt connector in the luggage compartment

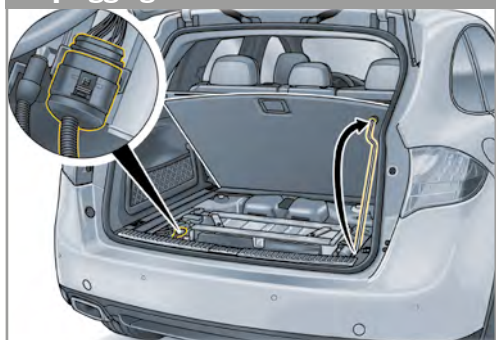

1. Open the luggage compartment cover.
The 12-volt connector to be unplugged is on the left-hand side of the high-voltage battery.
2. Unplug the 12-volt connector.

- There is no voltage in the high-voltage system once it has been switched off.
- The passive safety systems (airbags and seat belt pre-tensioners) are still supplied with voltage from the on-board 12-volt battery.

Other accident situations

Vehicle in water

There is no risk that the car body will be live. Once the vehicle has been recovered:

1. Allow the water to run out of the interior.
2. Begin switching off the high-voltage system.

Vehicle fire

Suitable extinguishing agent:

water (H₂O)

Battery fire

Suitable extinguishing agent for a battery fire:

dry sand, carbon dioxide (CO₂)

⚠ WARNING Battery modules explode when hot!

Battery modules might explode if the high-voltage battery becomes too hot.

- Keep to the required safety distances when fighting the fire.



**Porsche AG, Cayenne/S/GTS/Turbo/Diesel/S Diesel/
Turbo S (92A) SUV
from Model Year 2015**

PORSCHE

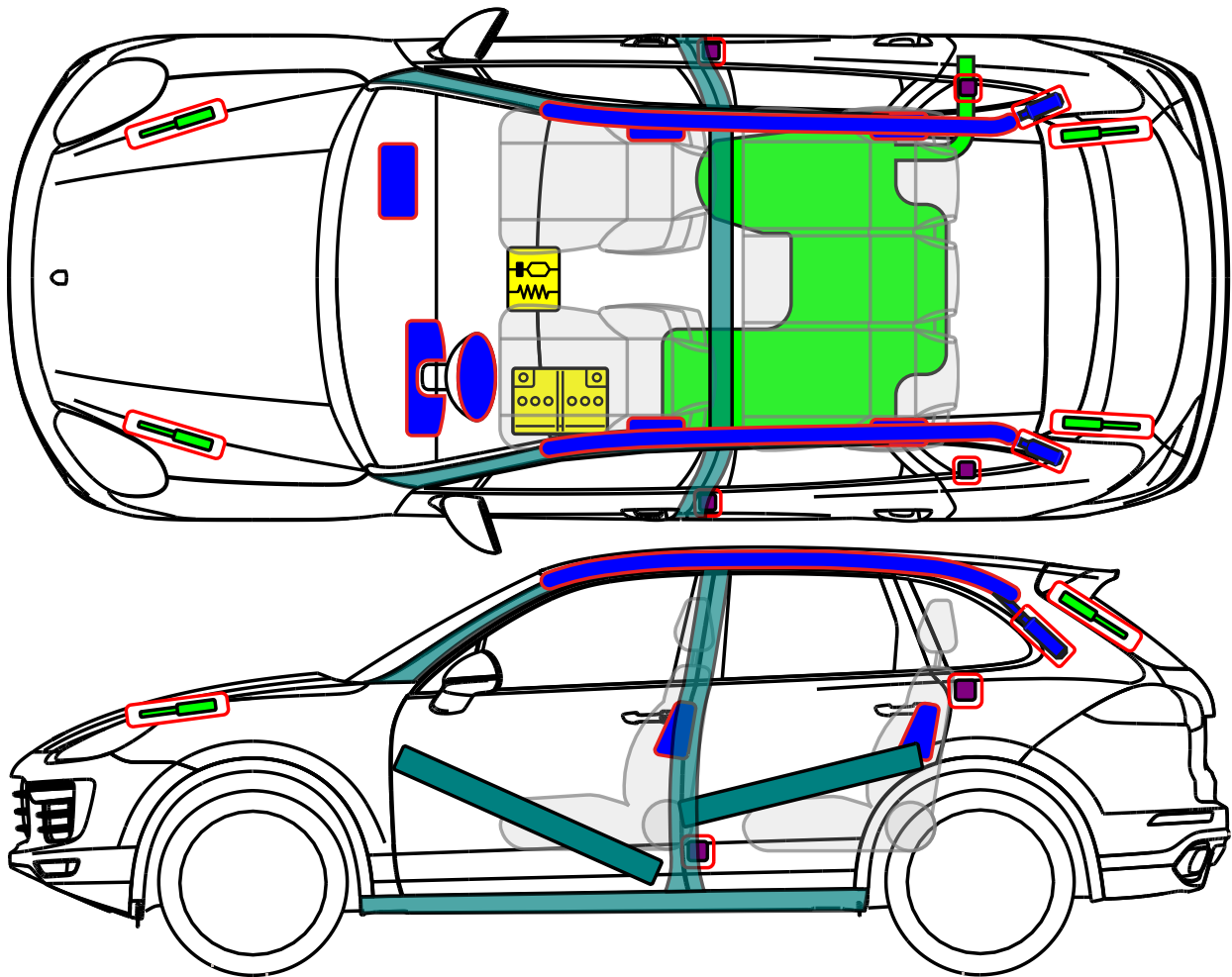

	Airbag		Body reinforcement		SRS-Control unit		High voltage battery
	Gas generator		Gas strut		12-volt Battery		High voltage cable / component
	Seat belt pretensioner		Pedestrian protection system		Fuse box		High voltage cut-off
	Fuel tank		Roll-over protection		Condenser		



**Porsche AG, Cayenne S E-Hybrid (92A)
SUV
from Model Year 2015**

PORSCHE

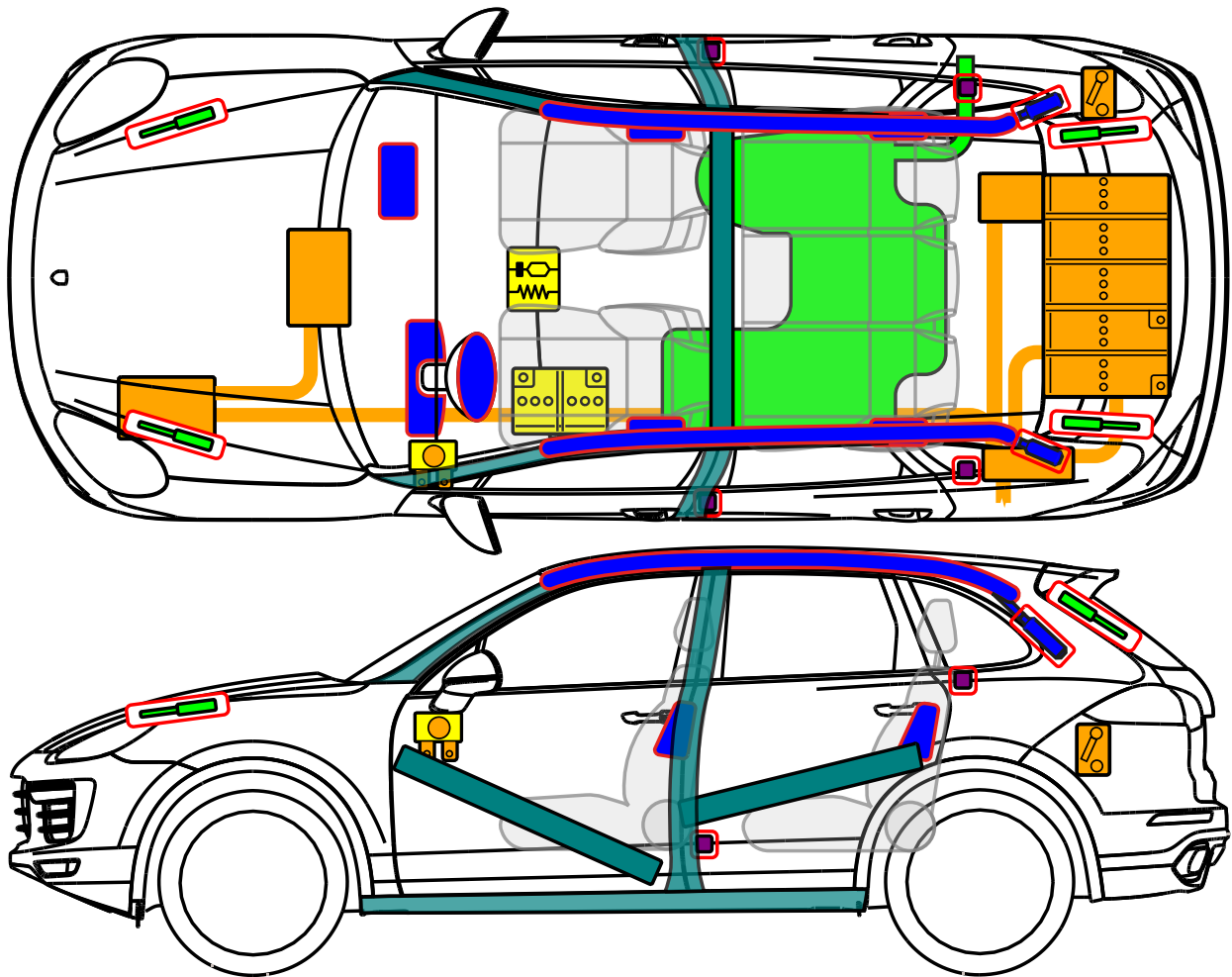

	Airbag		Body reinforcement		SRS-Control unit		High voltage battery
	Gas generator		Gas strut		12-volt Battery		High voltage cable / component
	Seat belt pretensioner		Pedestrian protection system		Fuse box		High voltage cut-off
	Fuel tank		Roll-over protection		Condenser		

Vehicle identification and marking

Cayenne S E-Hybrid identification features – standard equipment



“e-hybrid” logo on the **engine** cover

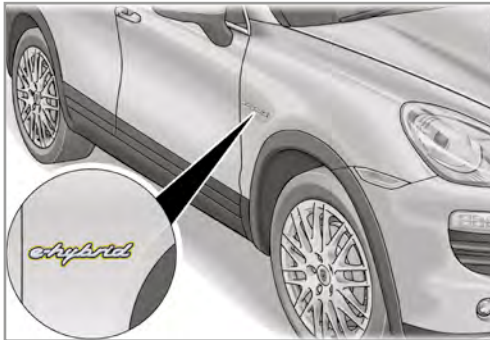

“e-hybrid” logo on the **right- and left-hand doors**

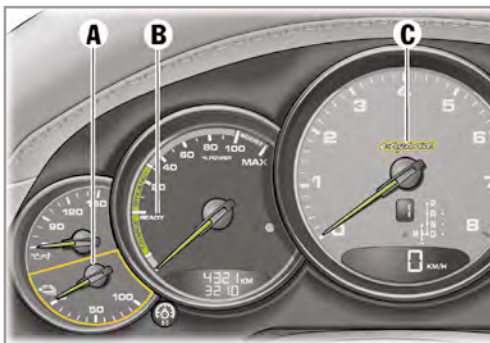

On the **instrument cluster**

A = battery charge state,
B = E-Power meter indicator,
C = “e-hybrid” logo

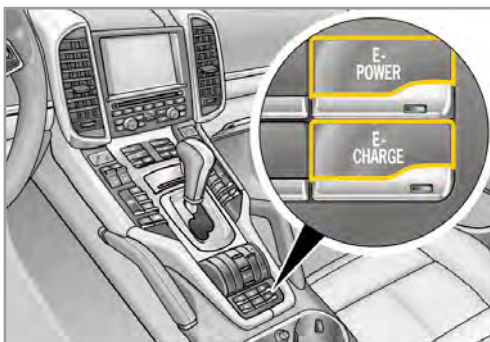

E-POWER and **E-CHARGE** buttons on the center console



Vehicle charging connection behind the charging-socket lid on rear left side of the vehicle

Marking of the hybrid components



All high-voltage components are clearly marked with warning labels.

Orange insulation is used on all high-voltage lines.

Safety information about the hybrid system

Undamaged plugs, connectors, cables and sockets in the high-voltage vehicle electrical system are safe to touch.

⚠ DANGER Risk of serious or fatal injury from electric shock if handled incorrectly!

If high-voltage components are not handled correctly, there is a risk of fatal injury from high voltage and the possible flow of current through the human body.

- Do not touch high-voltage components that are in operation.
- Do not damage the orange high-voltage lines in the high-voltage vehicle electrical system.
- There may still be voltage in the high-voltage battery even after the high-voltage vehicle electrical system has been deactivated. The high-voltage battery must not be damaged or opened.

Switching off the passive safety system and high-voltage system

⚠ WARNING The electric motor is silent when stationary!

You cannot always tell from the operating noise whether the vehicle is ready to start because the electric motor is silent when stationary.

- The vehicle may be ready to start even when no engine noises can be heard.
- If the ignition is switched on, the combustion engine may start automatically depending on the state of charge of the high-voltage battery.

NOTE

Deactivating the HV system

The high-voltage system switches off automatically in the event of accidents where the airbags or seat-belt pre-tensioners are triggered.

To make sure that the **high-voltage system** is deactivated, it is recommended – depending on accessibility – to use the **primary or secondary emergency disconnection point as the deactivation method:**

1. Primary emergency disconnection point: Switch ignition key to “OFF” and unplug the 12-volt service plug (marked with a flag) on the rear right side of the luggage compartment.
2. Secondary emergency disconnection point: Switch ignition key to “OFF” and pull out fuse number 40 (marked with a flag) in the front left fuse box.

Other deactivation methods as described in the Workshop Manuals may only be performed by appropriately qualified personnel.

NOTE

Deactivating the passive safety systems

The following steps should be taken to make sure that the **passive safety systems** (airbags and seat belt pre-tensioners) are switched off:

1. Disconnect the 12-volt battery in the driver’s footwell. The waiting time after disconnection of the 12-volt battery is 1 minute.
2. Switch off the high-voltage system via the primary or secondary emergency disconnection point to ensure there is no voltage in the on-board 12-volt battery network.

Deactivating the high-voltage system

Switching off the ignition

The method of switching off the high-voltage system described below applies to both vehicles with a conventional key and those with Porsche Entry & Drive (keyless entry system). In either case, the ignition key must be turned to “OFF” position first.

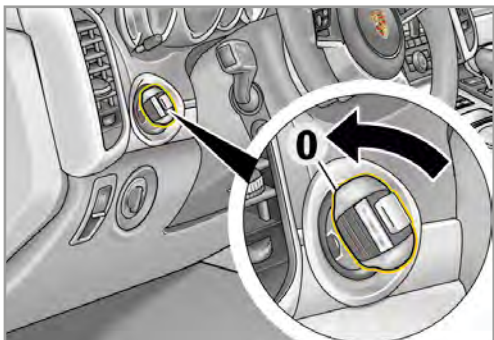

1. Turn the ignition key to “OFF” (position -0-).

Primary emergency disconnection point: unplugging the 12-volt service plug on the rear right side of the luggage compartment

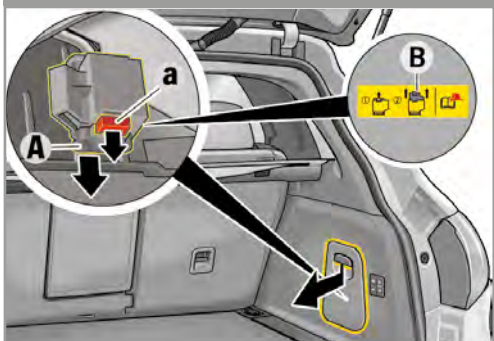

1. Unplug the 12-volt service plug.
2. Unplug -a- and open -A- the service plug (marked with a flag -B-).

- There is no voltage in the high-voltage system approx. 20 seconds after it has been switched off.
- The passive safety systems, such as airbags and seat-belt pre-tensioners, are still supplied with voltage from the on-board 12-volt battery.

Secondary emergency disconnection point: removing fuse number 40 from the fuse box on the left-hand side of the dashboard

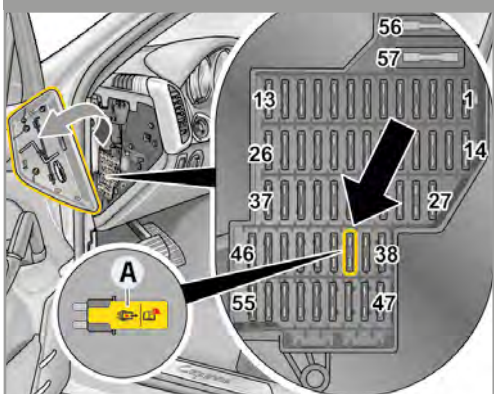

1. Open the lid of the fuse box on the left-hand side of the dashboard.
2. Unplug fuse number **40** (marked with a flag **A**).

- There is no voltage in the high-voltage system approx. 20 seconds after it has been switched off.
- The passive safety systems, such as airbags and seat-belt pretensioners, are still supplied with voltage from the on-board 12-volt battery.

Deactivating the passive safety systems

Disconnecting the 12-volt battery

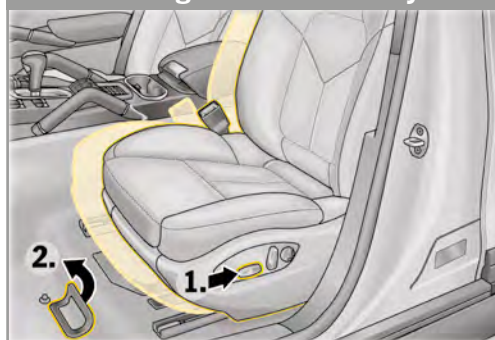

Make sure that no jumper cables are connected to the vehicle.

1. If possible, move the driver's seat back to the furthest position (-1).
2. Remove the carpet section (-2-) in the front left footwell.



3. Detach the negative cable of the 12-volt battery at the threaded connection (-3-) and secure it against unintentional contact (-4-).

- Additionally deactivate the HV system at an emergency disconnection point.
- The passive safety systems (airbags and seat belt pre-tensioners) are deactivated. The waiting time after disconnection of the 12-volt battery is 1 minute.

Other accident situations

Vehicle in water

There is no risk that the vehicle body will be live. Once the vehicle has been recovered:

1. Allow the water to run out of the interior and
2. Start deactivating the high-voltage system.

Vehicle/battery fire

Suitable extinguishing agent:

water (H₂O), larger quantities to cool the lithium ion battery

Battery fire

Suitable extinguishing agent for a battery fire:

dry sand, carbon dioxide (CO₂)

⚠ WARNING Battery cells explode when hot!

Battery modules might explode if the high-voltage battery becomes too hot.

- Keep to the required safety distances when fighting the fire.



**Porsche AG, Boxter/S/Spyder (987)
Cabriolet
from Model Year 2005**

PORSCHE

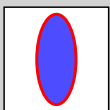
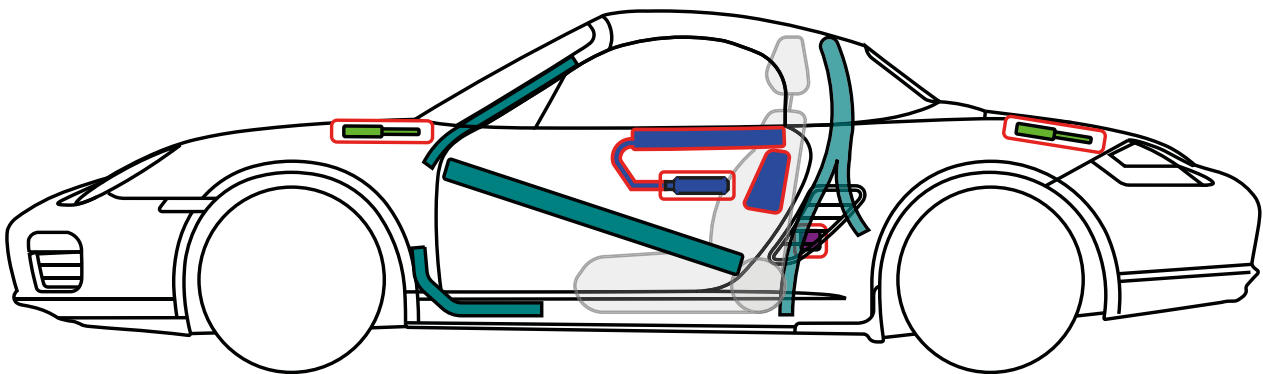
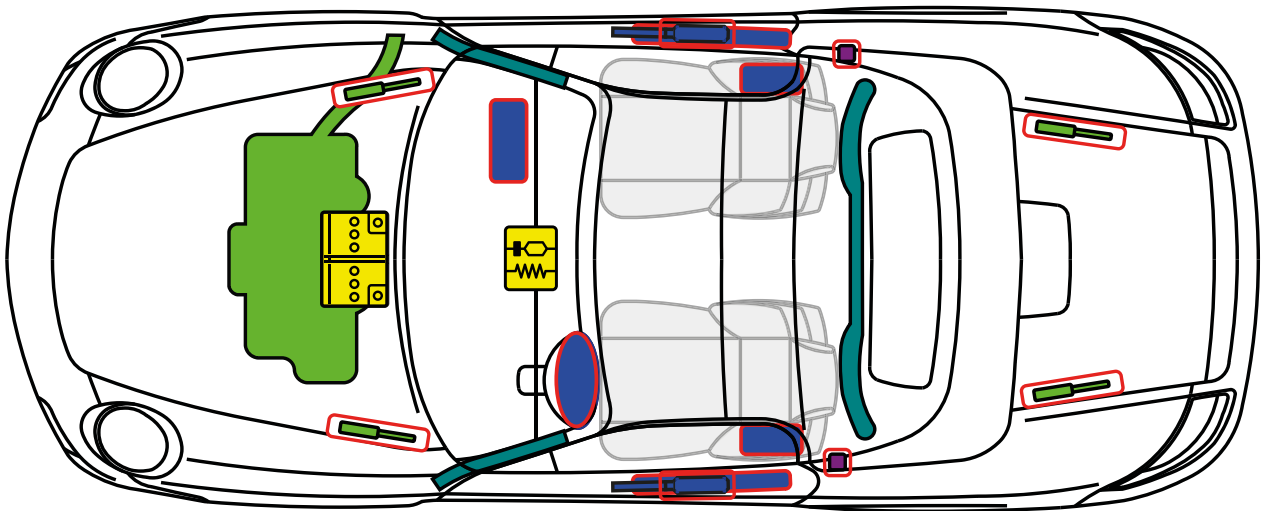

Airbag

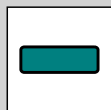

Body reinforcement

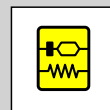

Control unit

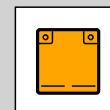

High-voltage battery

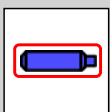

Gas generator

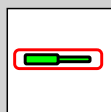

Gas strut

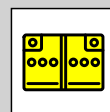

Battery



High-voltage cable/component



Gas generator

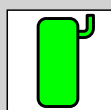

Fuel tank

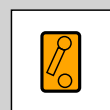

High-voltage cut-off



**Porsche AG, Cayman/S/R (987)
Coupé
from Model Year 2006**

PORSCHE

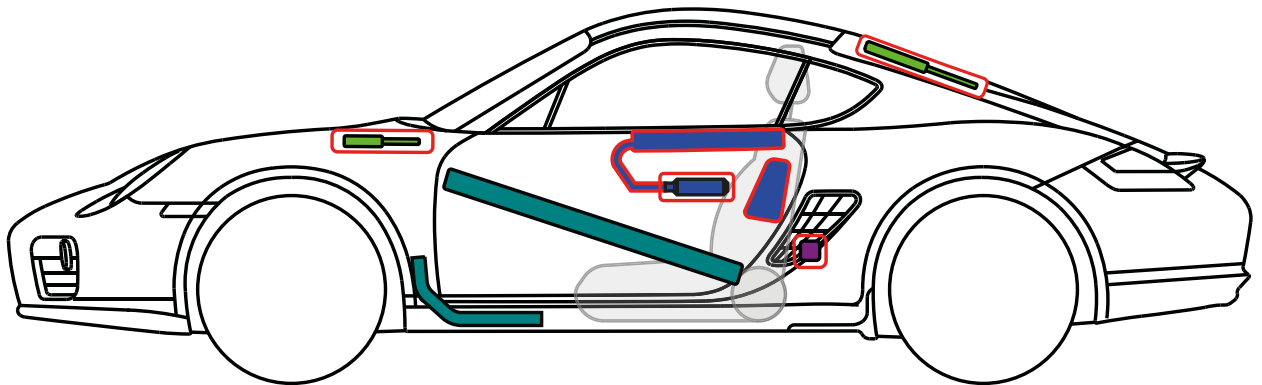
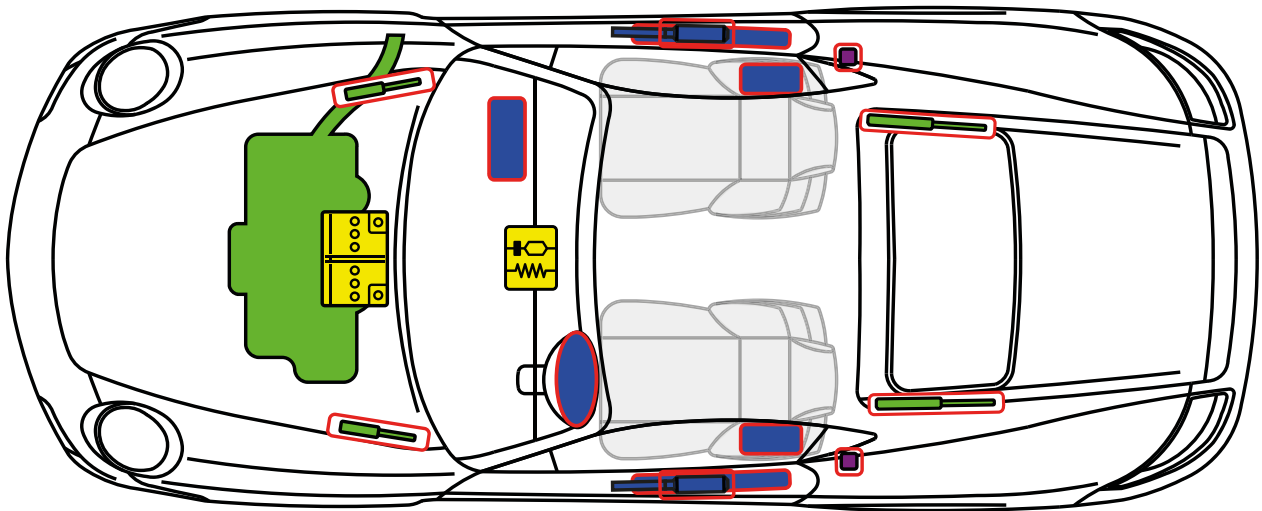

	Airbag		Body reinforcement		SRS-Control unit		High voltage battery
	Gas generator		Gas strut		12-volt Battery		High voltage cable / component
	Seat belt pretensioner		Pedestrian protection system		Fuse box		High voltage cut-off
	Fuel tank		Roll-over protection		Condenser		



**Porsche AG, 911 Carrera/S/4/4S/GTS/4 GTS/
Turbo/Turbo S (991) Coupé
from Model Year 2012**

PORSCHE

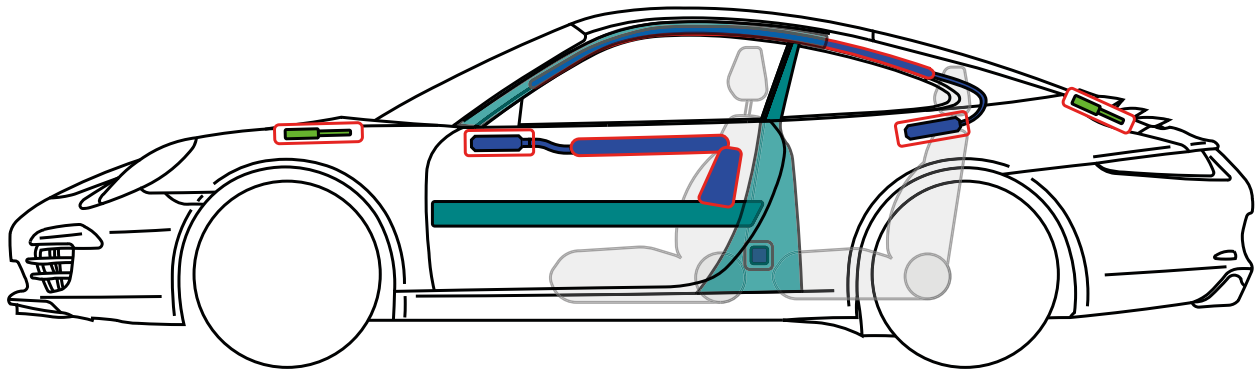
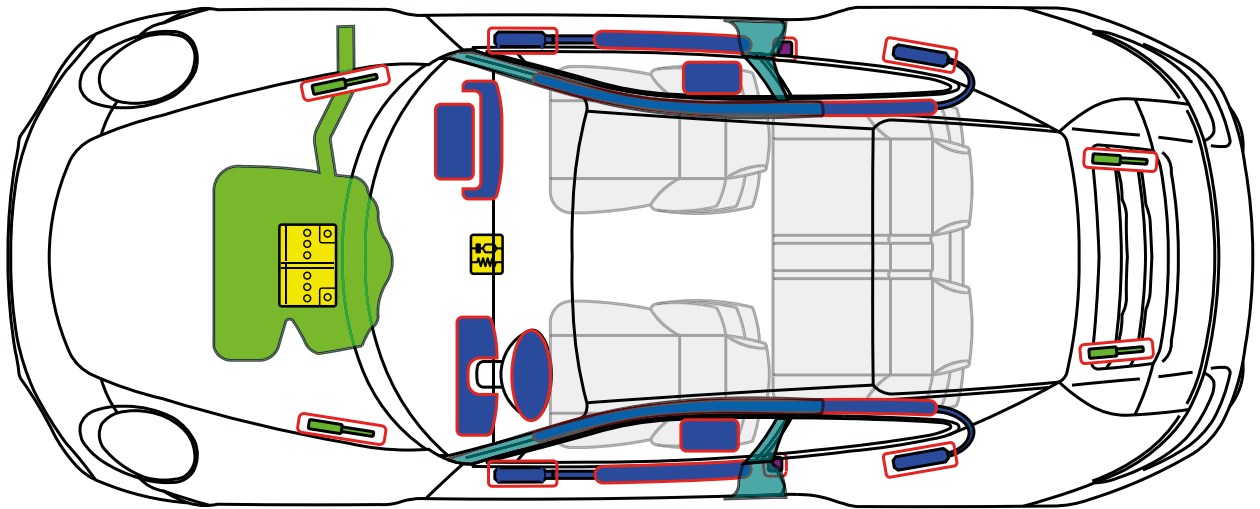

	Airbag		Body reinforcement		SRS-Control unit		High voltage battery
	Gas generator		Gas strut		12-volt Battery		High voltage cable / component
	Seat belt pretensioner		Pedestrian protection system		Fuse box		High voltage cut-off
	Fuel tank		Roll-over protection		Condenser		



**Porsche AG, 911 Carrera/S/4/4S/GTS/4 GTS/Turbo/
Turbo S (991) Cabriolet
from Model Year 2012**

PORSCHE

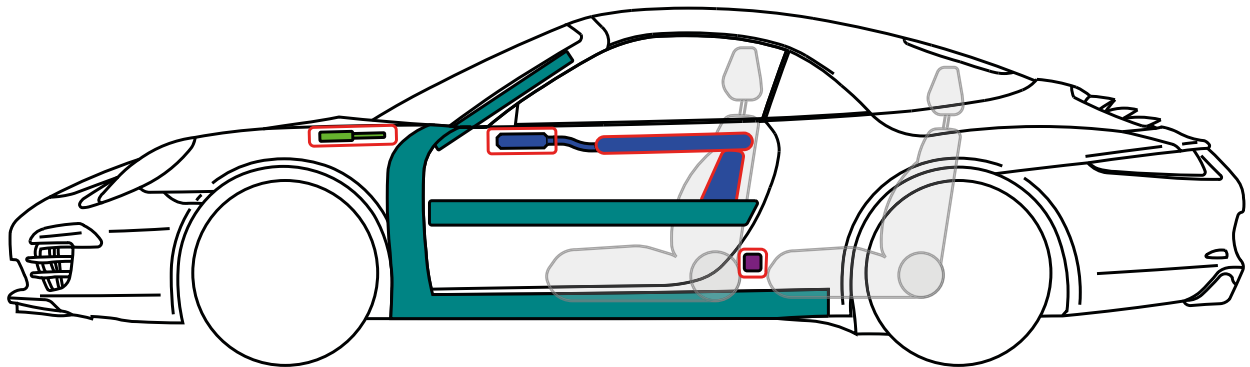
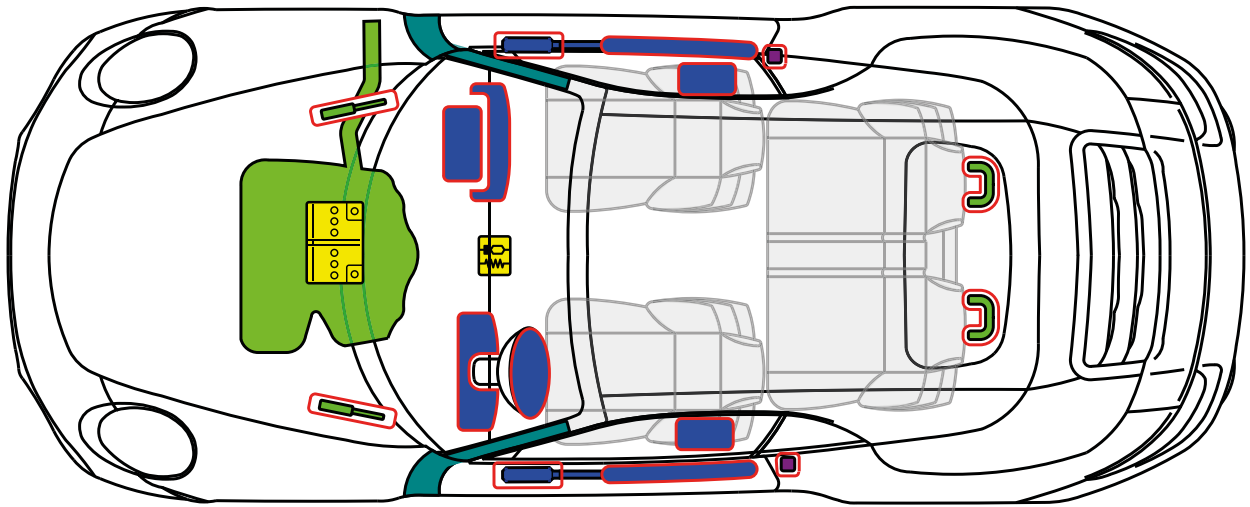

	Airbag		Body reinforcement		SRS-Control unit		High voltage battery
	Gas generator		Gas strut		12-volt Battery		High voltage cable / component
	Seat belt pretensioner		Pedestrian protection system		Fuse box		High voltage cut-off
	Fuel tank		Roll-over protection		Condenser		



**Porsche AG, 911 GT3/RS
(991) Coupé
from Model Year 2014**

PORSCHE

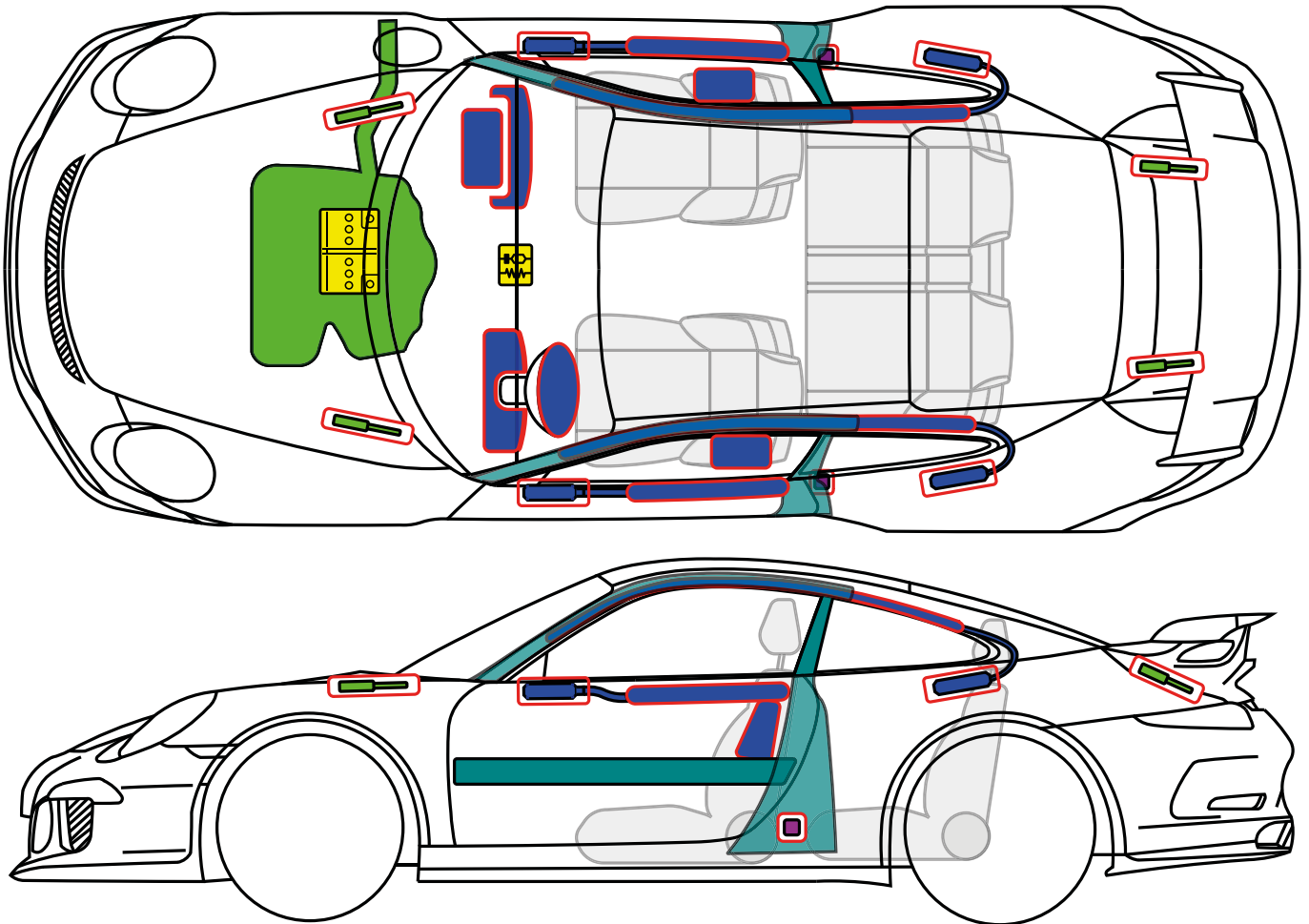

	Airbag		Body reinforcement		SRS-Control unit		High voltage battery
	Gas generator		Gas strut		12-volt Battery		High voltage cable / component
	Seat belt pretensioner		Pedestrian protection system		Fuse box		High voltage cut-off
	Fuel tank		Roll-over protection		Condenser		



**Porsche AG, 911 Targa 4/4S/GTS
(991) Coupé
from Model Year 2014**

PORSCHE

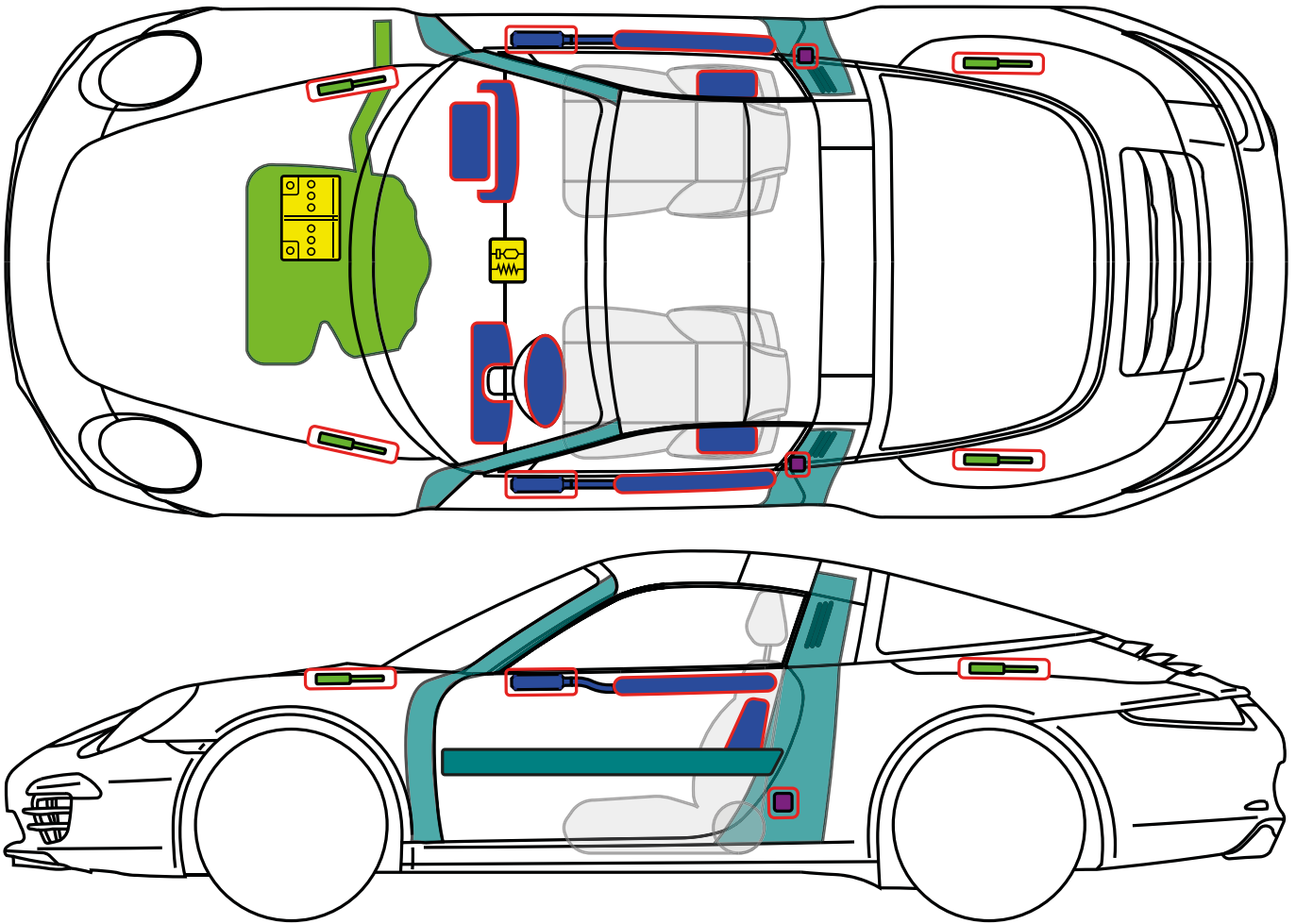

	Airbag		Body reinforcement		SRS-Control unit		High voltage battery
	Gas generator		Gas strut		12-volt Battery		High voltage cable / component
	Seat belt pretensioner		Pedestrian protection system		Fuse box		High voltage cut-off
	Fuel tank		Roll-over protection		Condenser		



**Porsche AG, 911 Carrera/S/4/4S/GTS/4 GTS
(997) Coupé
from Model Year 2005**

PORSCHE

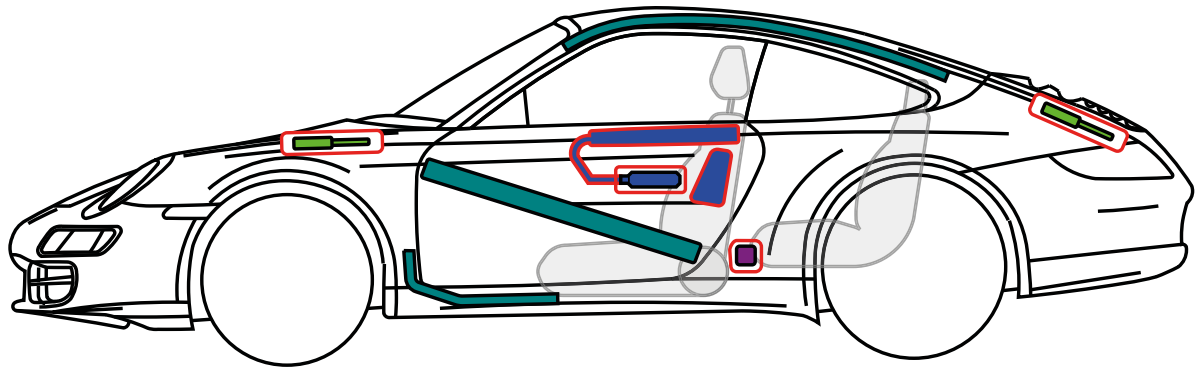
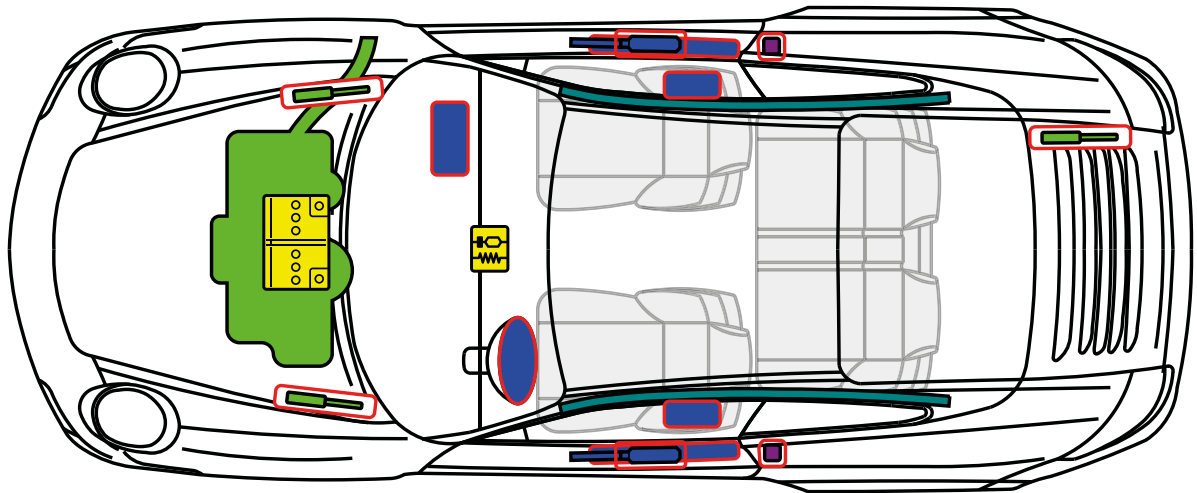

	Airbag		Body reinforcement		SRS-Control unit		High voltage battery
	Gas generator		Gas strut		12-volt Battery		High voltage cable / component
	Seat belt pretensioner		Pedestrian protection system		Fuse box		High voltage cut-off
	Fuel tank		Roll-over protection		Condenser		



**Porsche AG, 911 Carrera/S/4/4S/GTS/4 GTS/
Speedster (997) Cabriolet
from Model Year 2005**

PORSCHE

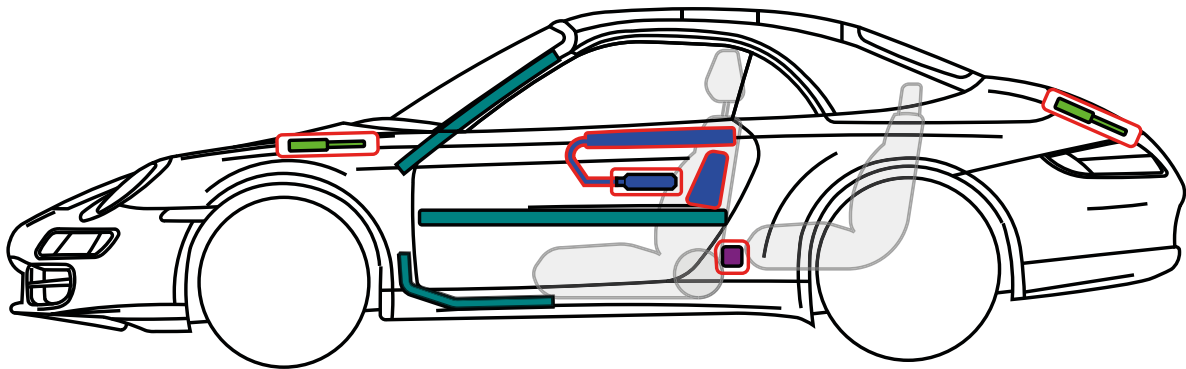
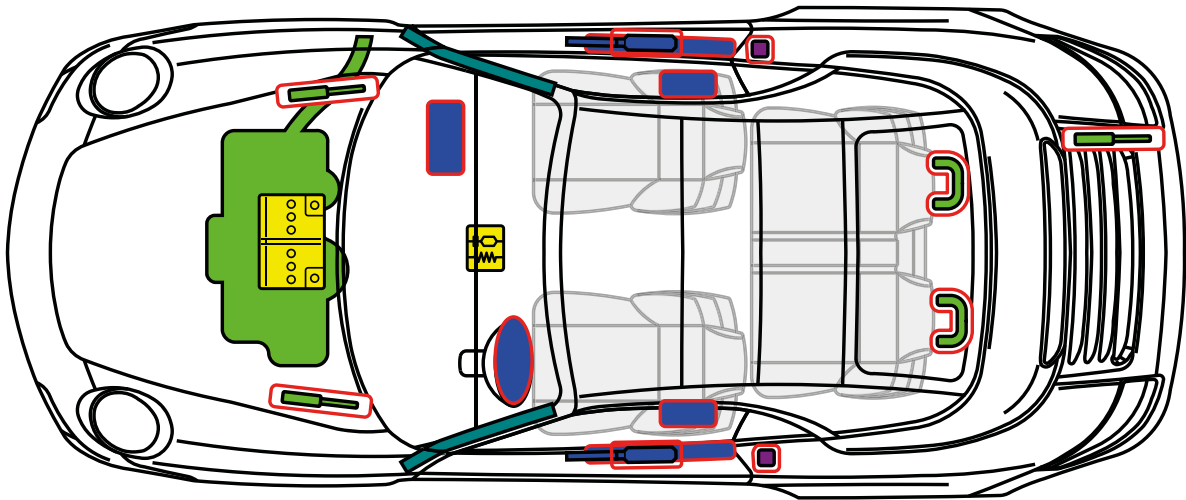

	Airbag		Body reinforcement		SRS-Control unit		High voltage battery
	Gas generator		Gas strut		12-volt Battery		High voltage cable / component
	Seat belt pretensioner		Pedestrian protection system		Fuse box		High voltage cut-off
	Fuel tank		Roll-over protection		Condenser		



**Porsche AG, 911 Targa 4/4S
(1997) Coupé
from Model Year 2007**

PORSCHE

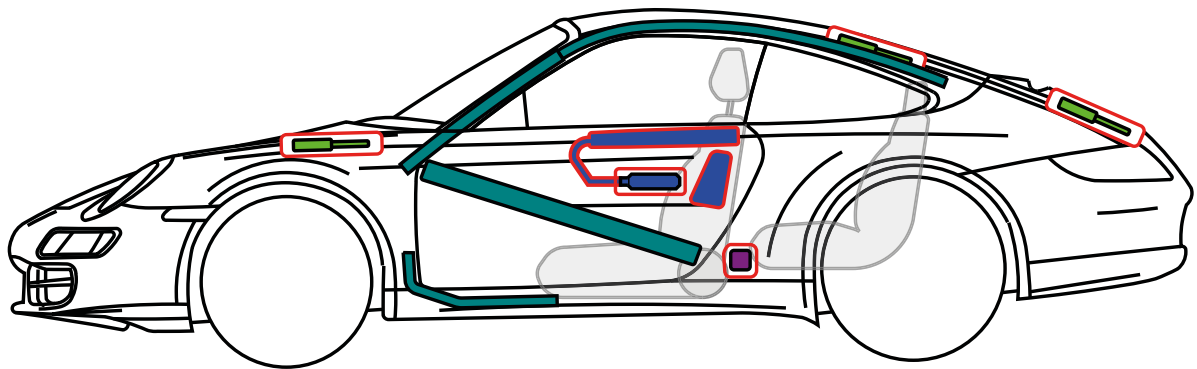
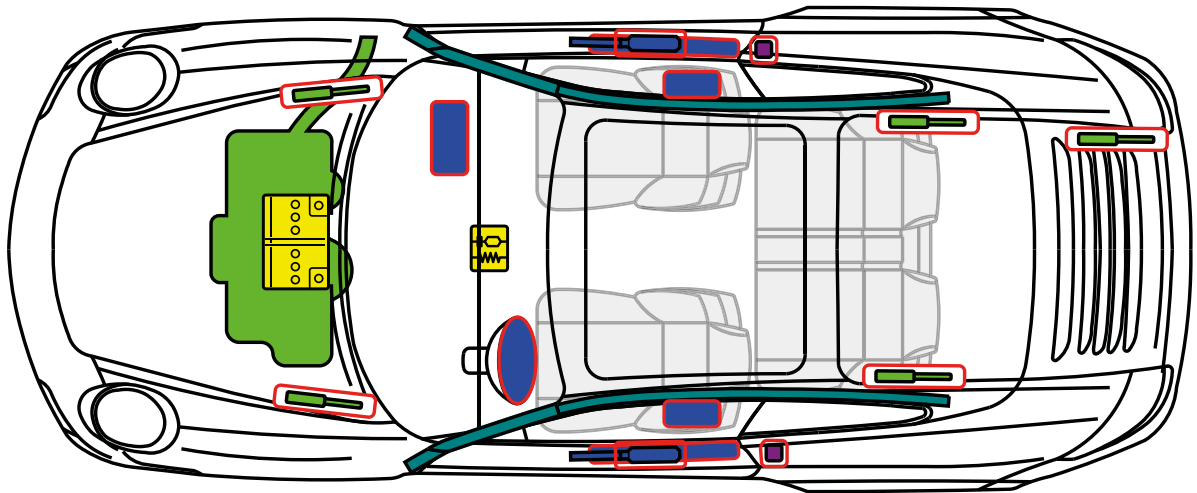

	Airbag		Body reinforcement		SRS-Control unit		High voltage battery
	Gas generator		Gas strut		12-volt Battery		High voltage cable / component
	Seat belt pretensioner		Pedestrian protection system		Fuse box		High voltage cut-off
	Fuel tank		Roll-over protection		Condenser		



Porsche AG, 911 Turbo/S (1997)
Coupé
from Model Year 2007

PORSCHE

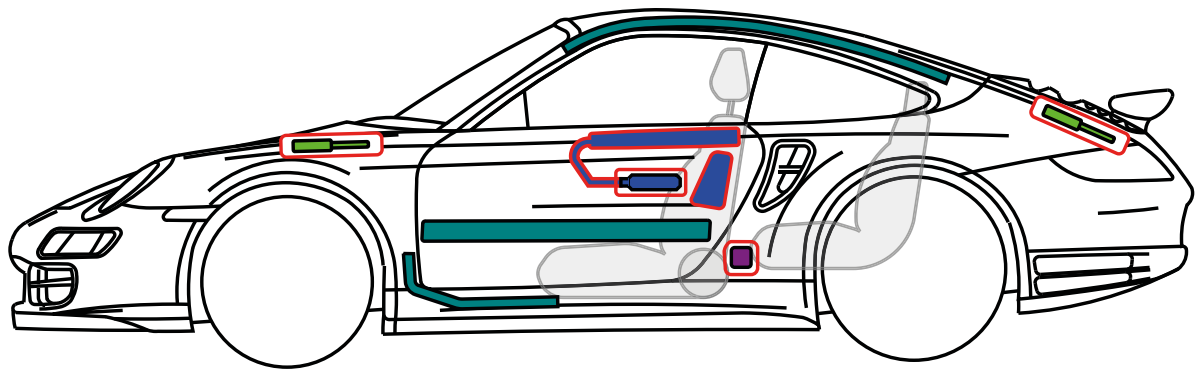
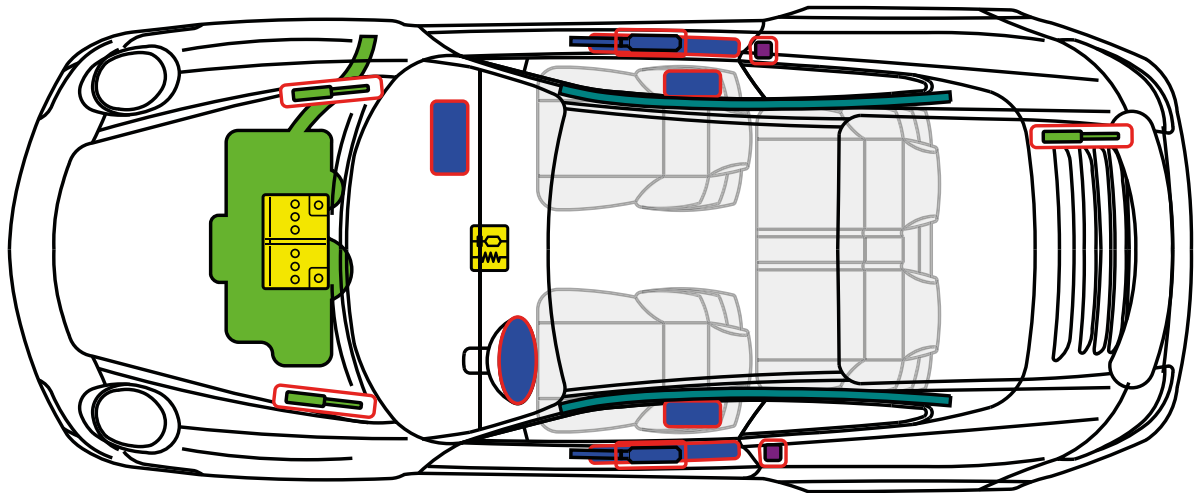

	Airbag		Body reinforcement		SRS-Control unit		High voltage battery
	Gas generator		Gas strut		12-volt Battery		High voltage cable / component
	Seat belt pretensioner		Pedestrian protection system		Fuse box		High voltage cut-off
	Fuel tank		Roll-over protection		Condenser		



Porsche AG, 911 Turbo/S (1997)
Cabriolet
from Model Year 2007

PORSCHE

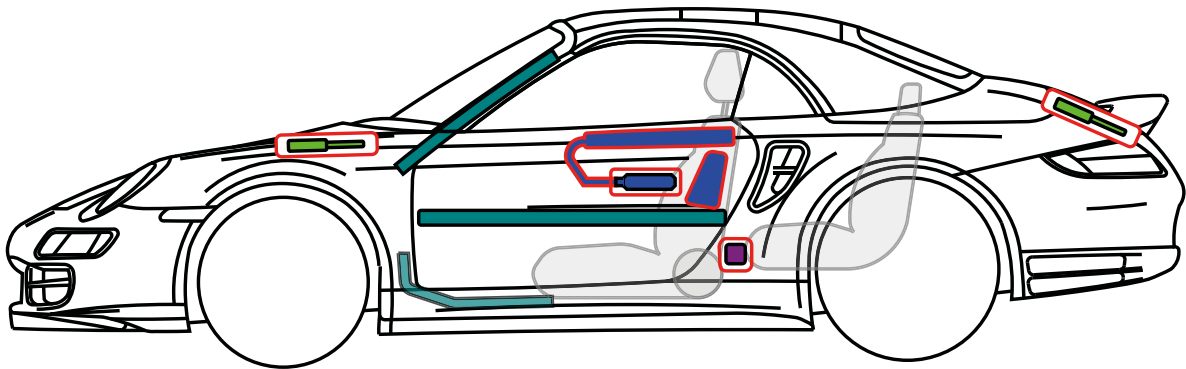
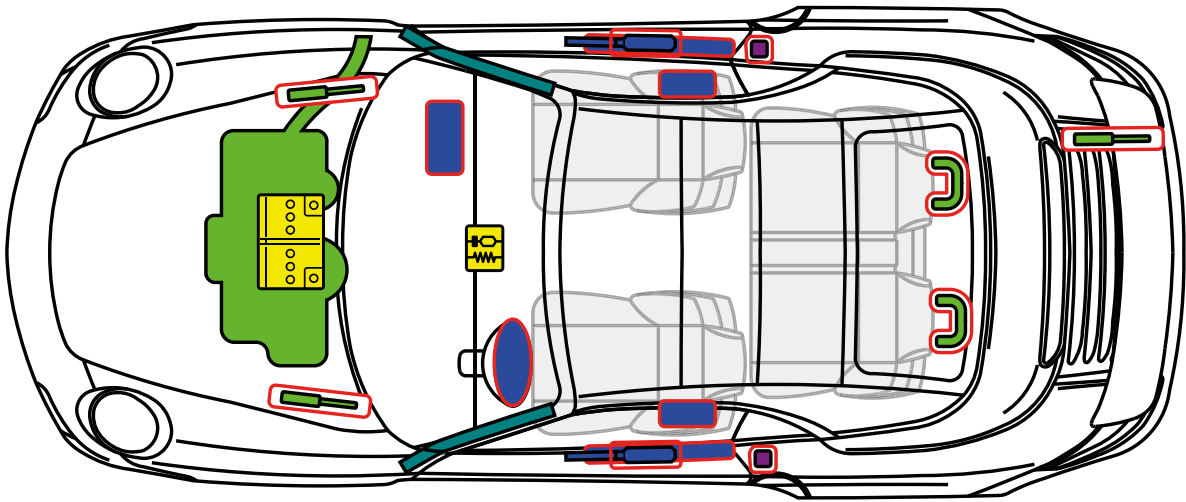

	Airbag		Body reinforcement		SRS-Control unit		High voltage battery
	Gas generator		Gas strut		12-volt Battery		High voltage cable / component
	Seat belt pretensioner		Pedestrian protection system		Fuse box		High voltage cut-off
	Fuel tank		Roll-over protection		Condenser		



Porsche AG, 911 GT3 (997)
Coupé
from Model Year 2007

PORSCHE

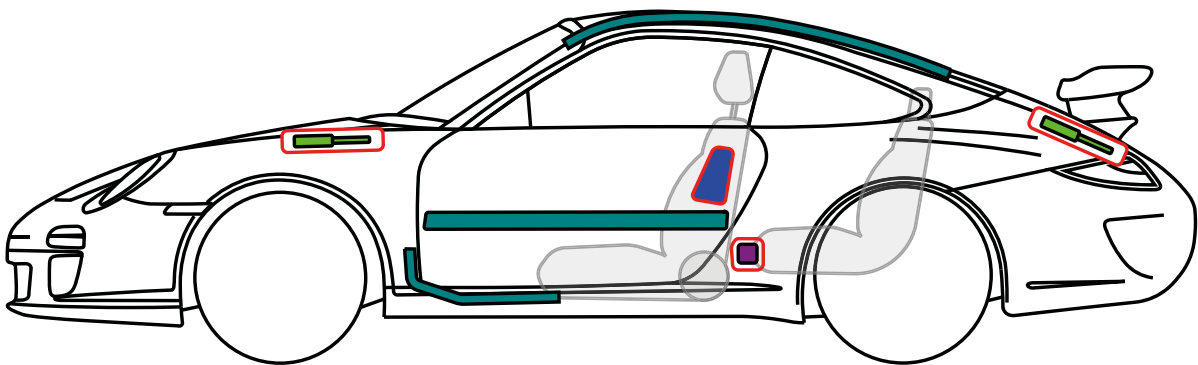
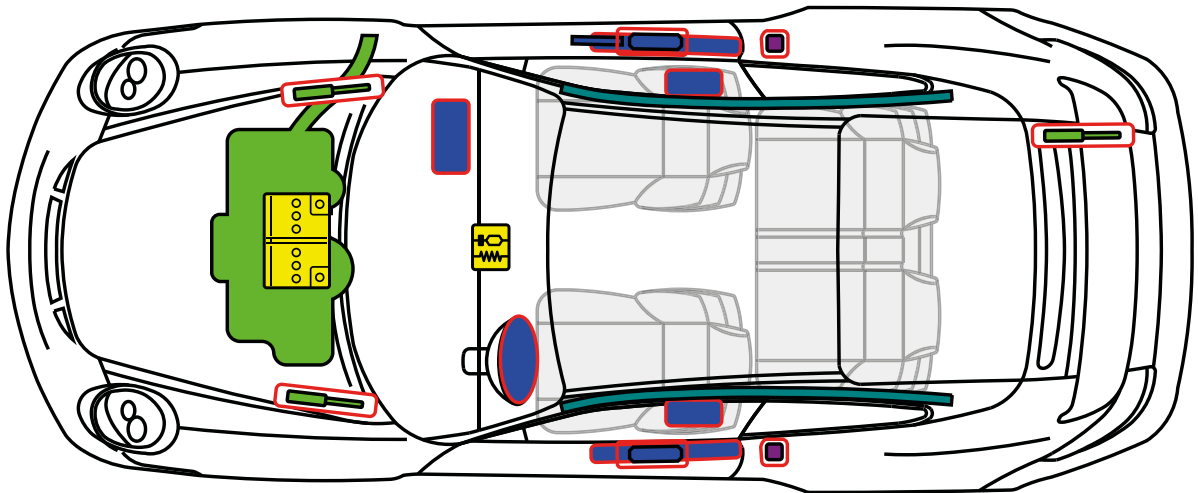

	Airbag		Body reinforcement		SRS-Control unit		High voltage battery
	Gas generator		Gas strut		12-volt Battery		High voltage cable / component
	Seat belt pretensioner		Pedestrian protection system		Fuse box		High voltage cut-off
	Fuel tank		Roll-over protection		Condenser		



Porsche AG, 911 GT3 RS (997)
Coupé
from Model Year 2007

PORSCHE

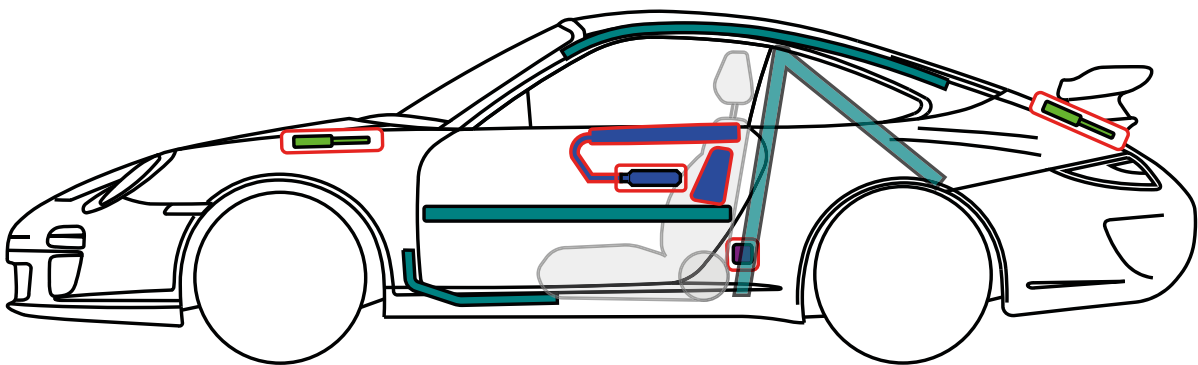
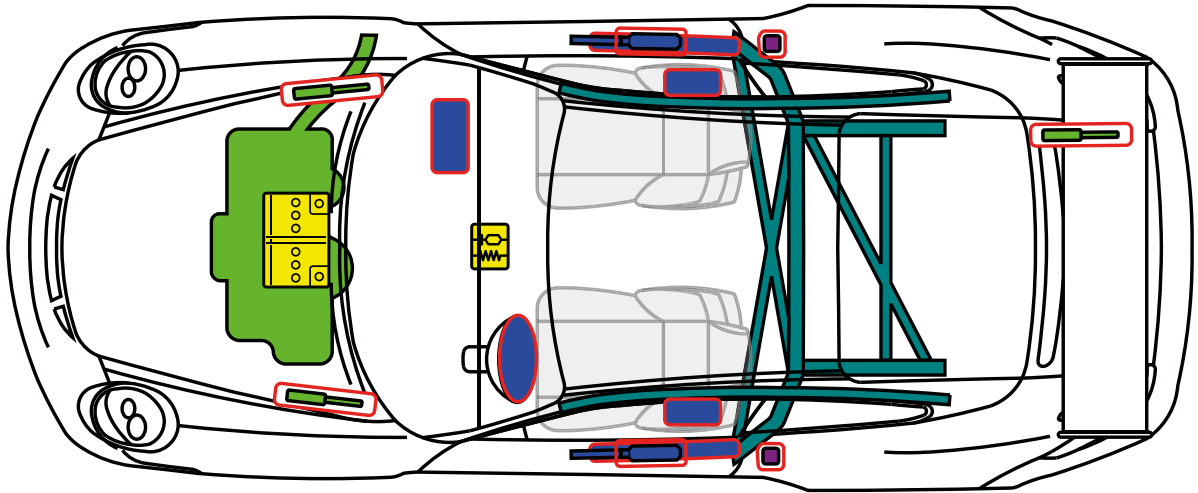

	Airbag		Body reinforcement		SRS-Control unit		High voltage battery
	Gas generator		Gas strut		12-volt Battery		High voltage cable / component
	Seat belt pretensioner		Pedestrian protection system		Fuse box		High voltage cut-off
	Fuel tank		Roll-over protection		Condenser		



**Porsche AG, 911 GT2 (997)
Coupé
from Model Year 2008**

PORSCHE

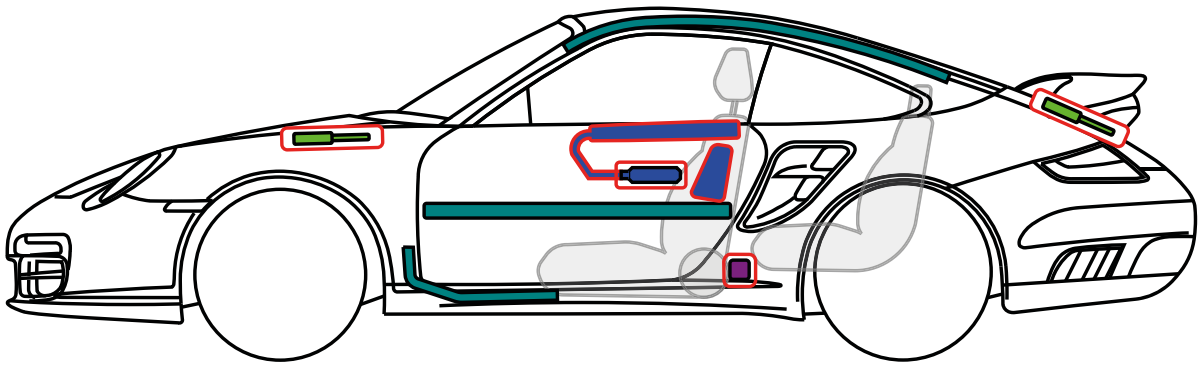
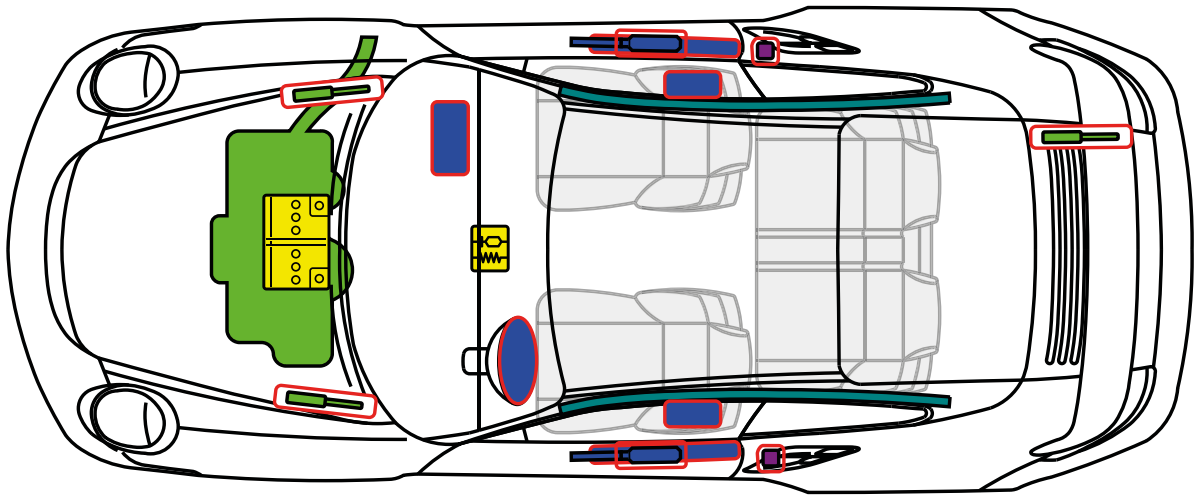

	Airbag		Body reinforcement		SRS-Control unit		High voltage battery
	Gas generator		Gas strut		12-volt Battery		High voltage cable / component
	Seat belt pretensioner		Pedestrian protection system		Fuse box		High voltage cut-off
	Fuel tank		Roll-over protection		Condenser		



**Porsche AG, 911 GT2 RS (997)
Coupé
from Model Year 2011**

PORSCHE

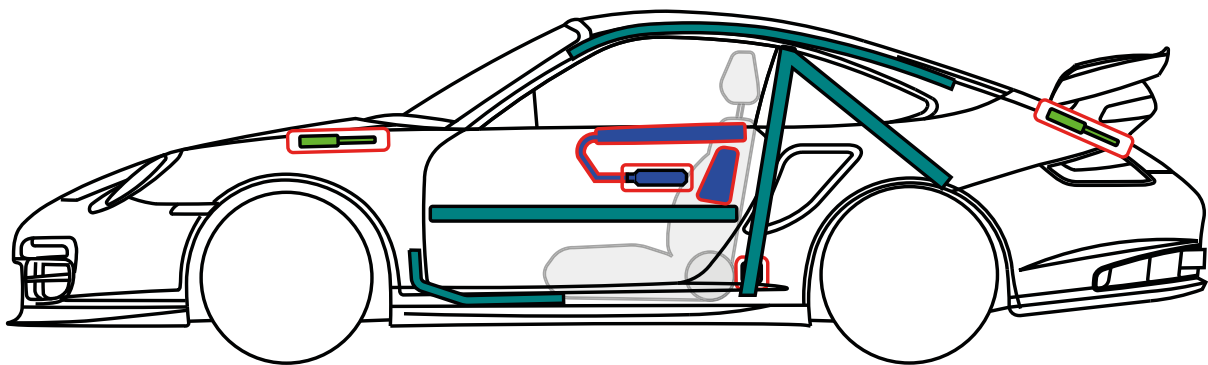
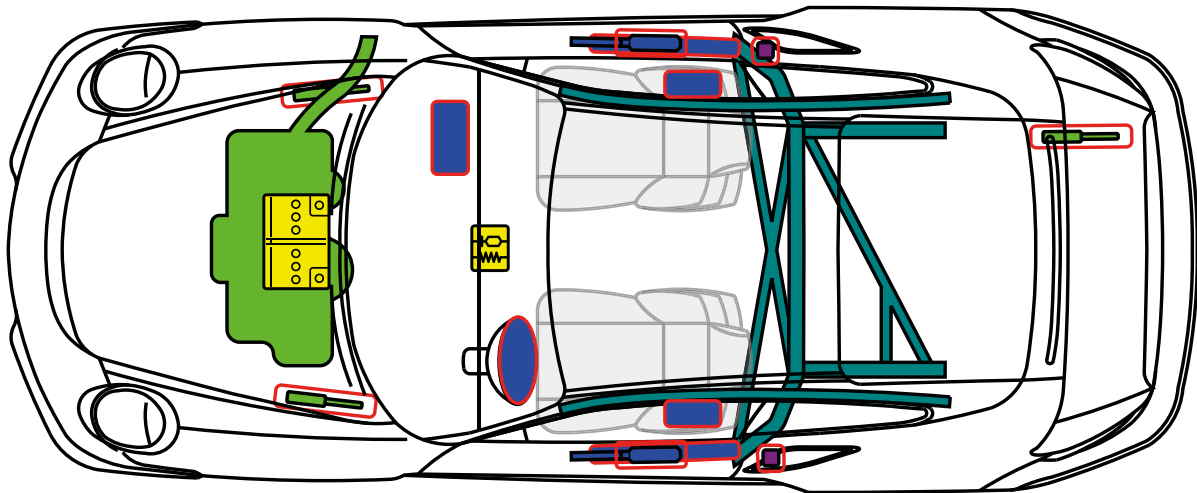

	Airbag		Body reinforcement		SRS-Control unit		High voltage battery
	Gas generator		Gas strut		12-volt Battery		High voltage cable / component
	Seat belt pretensioner		Pedestrian protection system		Fuse box		High voltage cut-off
	Fuel tank		Roll-over protection		Condenser		



**Porsche AG, Panamera/S/4/4S/GTS/Turbo/Diesel/
Turbo S (970) Coupé (incl. Executive models)
from Model Year 2010**

PORSCHE

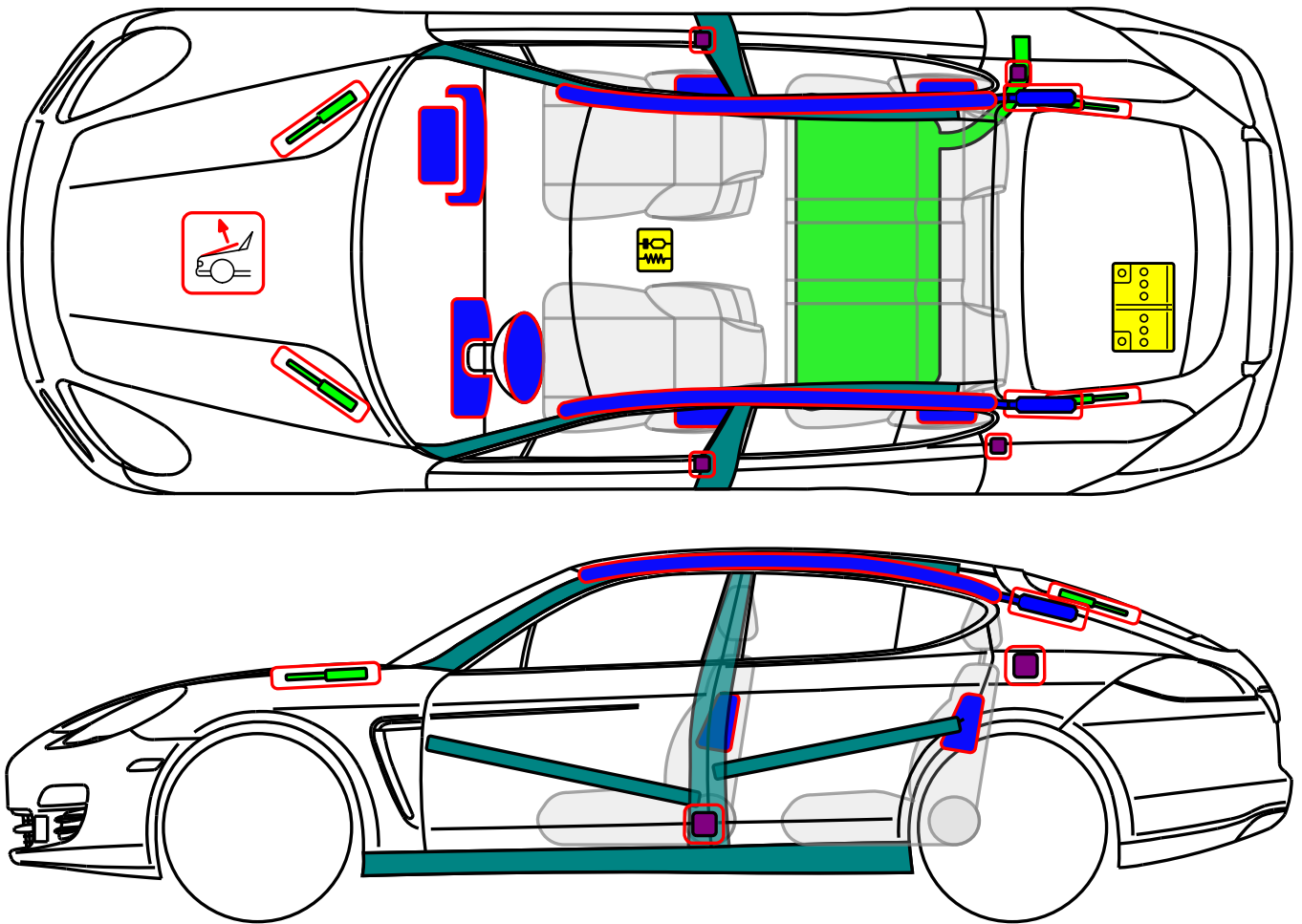

	Airbag		Body reinforcement		SRS-Control unit		High voltage battery
	Gas generator		Gas strut		12-volt Battery		High voltage cable / component
	Seat belt pretensioner		Pedestrian protection system		Fuse box		High voltage cut-off
	Fuel tank		Roll-over protection		Condenser		



**Porsche AG, Panamera S Hybrid (970)
Coupé
from Model Year 2011**

PORSCHE

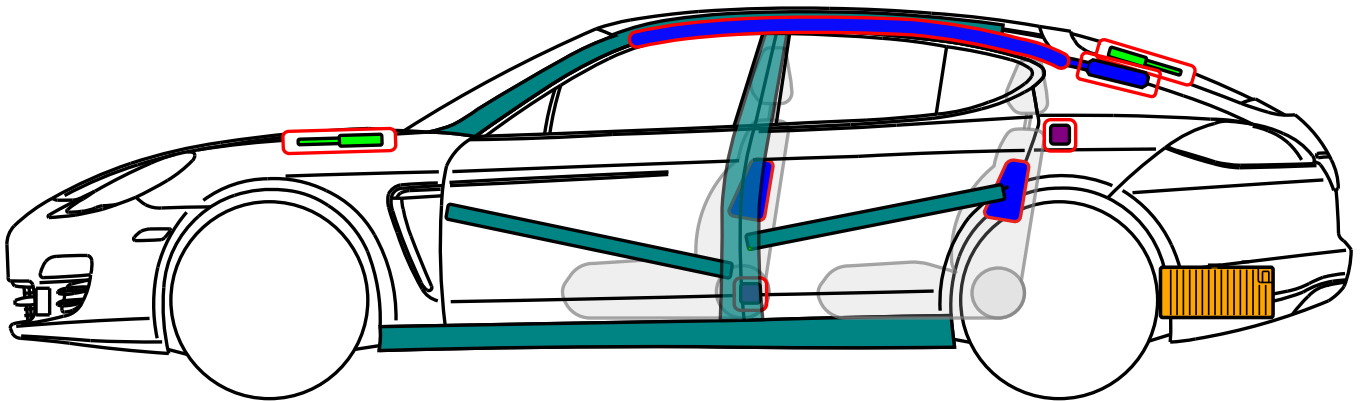
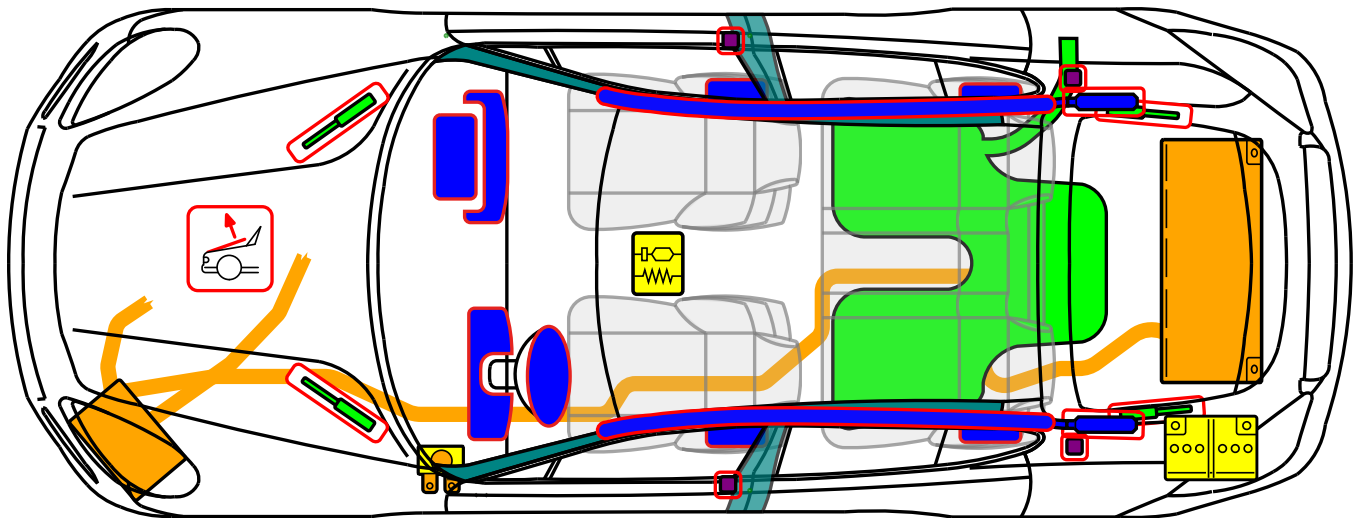

	Airbag		Body reinforcement		SRS-Control unit		High voltage battery
	Gas generator		Gas strut		12-volt Battery		High voltage cable / component
	Seat belt pretensioner		Pedestrian protection system		Fuse box		High voltage cut-off
	Fuel tank		Roll-over protection		Condenser		

Vehicle identification and marking

Panamera S Hybrid identification features

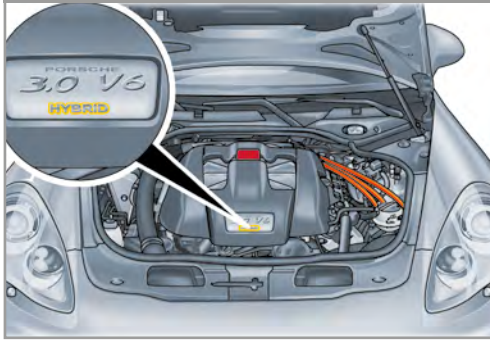

“Hybrid” logo on the engine cover

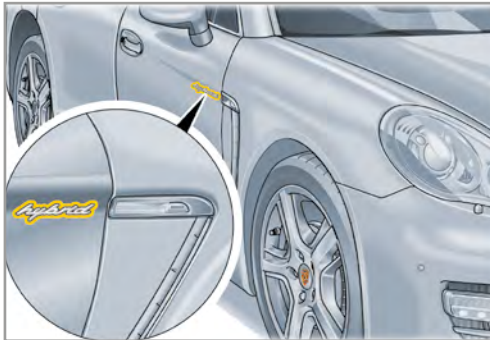

“Hybrid” logo on the right- and left-hand doors

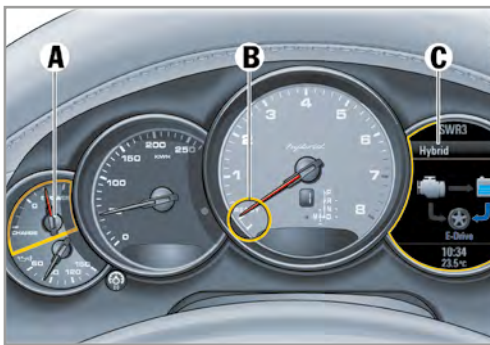

On the **instrument cluster**

A = E-Power meter,
B = READY indicator,
C = energy flow in the multifunction display

Marking of the hybrid components



All high-voltage components are clearly marked with warning labels.



Warning on the lockable plastic cover in the engine compartment.

All high-voltage cables have orange insulation.

Safety information about the hybrid system

Undamaged plugs, cables and sockets in the on-board high-voltage system are safe to touch.

DANGER

Risk of serious or fatal injury from electric shock if handled incorrectly!

If high-voltage components are not handled correctly, there is a risk of fatal injury.

- Do not touch high-voltage components that are in operation.
- Do not damage the orange high-voltage cables in the on-board high-voltage system.
- There may still be voltage in the high-voltage battery even after the on-board high-voltage system has been switched off. The high-voltage battery must not be damaged or opened.

Switching off the passive safety system and high-voltage system

WARNING

The electric motor is silent when stationary!

You cannot always tell from the operating noise whether the car is ready to start because the electric motor is silent when stationary.

- The vehicle may be ready to start even when no engine noises can be heard.
- The combustion engine may start automatically when the transmission is in “P” or “N” depending on the level of charge of the high-voltage battery.

NOTE

In the event of an accident where the airbags and seat belt pre-tensioners are activated

The high-voltage system switches off automatically in accidents where the airbags and seat belt pre-tensioners are activated.

NOTE

In the event of an accident where the airbags and seat belt pre-tensioners are not activated

The following steps should be taken to make sure that the **high-voltage system** is switched off. Depending on accessibility, the **deactivation method** should be **selected in the order stated below**:

1. Switch ignition key to "OFF".
or:
2. Remove fuse number 46 from the fuse box on the front left-hand side.
or:
3. Disconnect (negative terminal) the 12-volt battery in the luggage compartment. With this method, ensure that no jumper cables are connected to the vehicle.

Other deactivation methods as described in the manual (e.g. pulling out the service plug) may only be performed by appropriately qualified personnel.

To ensure that the **passive safety systems** (airbags and seat belt pre-tensioners) are deactivated, the 12-volt battery in the luggage compartment should be disconnected.

Switching off the ignition

The method of switching off the high-voltage system described below applies to both vehicles with a conventional key and those with Porsche Entry & Drive.

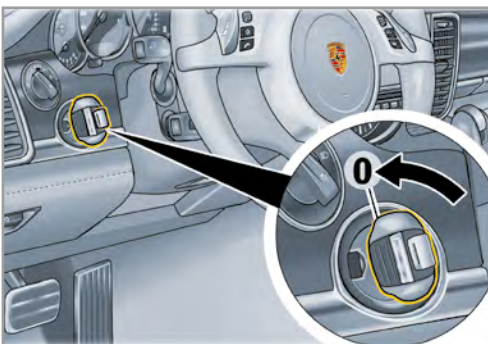

1. Turn the ignition key to "OFF" (0 position).

- There is no voltage in the high-voltage system approx. 20 seconds after it has been switched off.
- The passive safety systems, such as airbags and seat belt pre-tensioners, are still supplied with voltage from the on-board 12-volt battery.

Removing fuse number 46 from the fuse box on the left-hand side of the dashboard

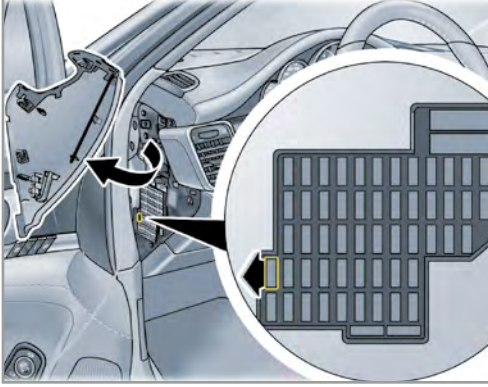

1. Open the lid of the fuse box on the left-hand side of the dashboard.
2. Pull out fuse number **46**.

- There is no voltage in the high-voltage system approx. 20 seconds after it has been switched off.
- The passive safety systems, such as airbags and seat belt pre-tensioners, are still supplied with voltage from the on-board 12-volt battery.

Disconnecting the 12-volt battery

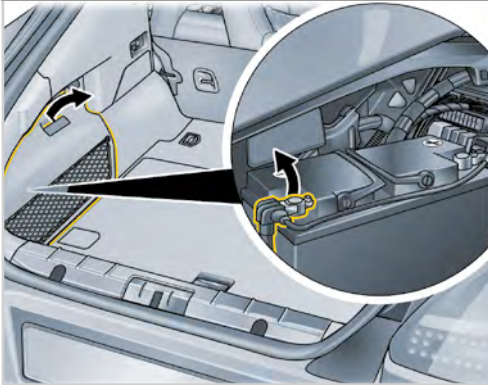

1. Ensure that no jumper cables are connected to the vehicle.
2. Remove the cover of the 12-volt battery on the rear left-hand side of the luggage compartment.
3. Disconnect the negative cable of the 12-volt battery and secure it to prevent accidental contact.

- There is no voltage in the high-voltage system approx. 20 seconds after it has been switched off.
- The passive safety systems (airbags and seat belt pre-tensioners) are deactivated.

Other accident situations

Vehicle in water

There is no risk that the car body will be live. Once the vehicle has been recovered:

1. Allow the water to run out of the interior.
2. Begin switching off the high-voltage system.

Vehicle fire

Suitable extinguishing agent:

water (H₂O)

Battery fire

Suitable extinguishing agent for a battery fire:

dry sand, carbon dioxide (CO₂)

WARNING

Battery modules explode when hot!

The battery modules might explode if the high-voltage battery becomes too hot.

→ Keep to the required safety distances when fighting the fire.



**Porsche AG, Panamera S E-Hybrid (970)
Coupé
from Model Year 2014**

PORSCHE

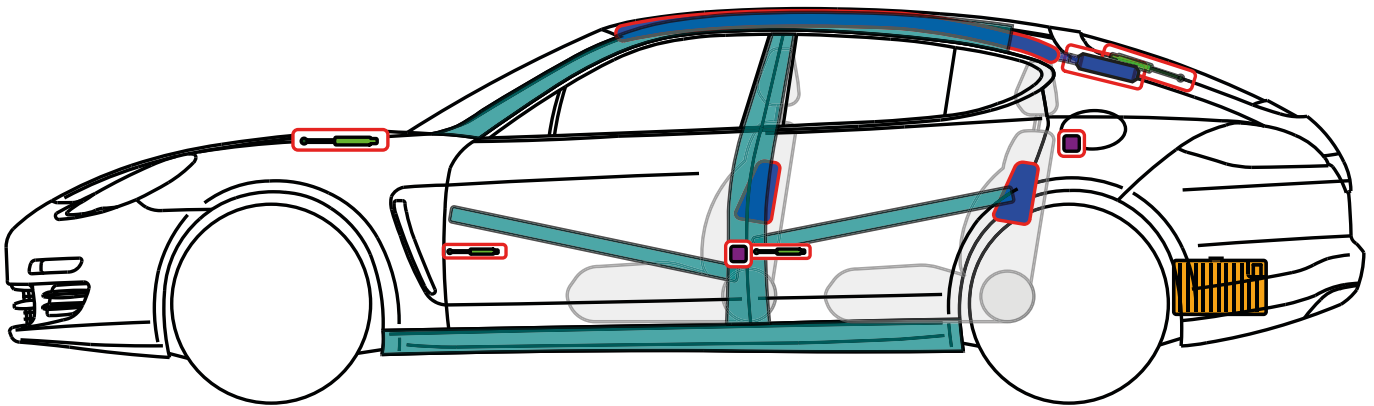
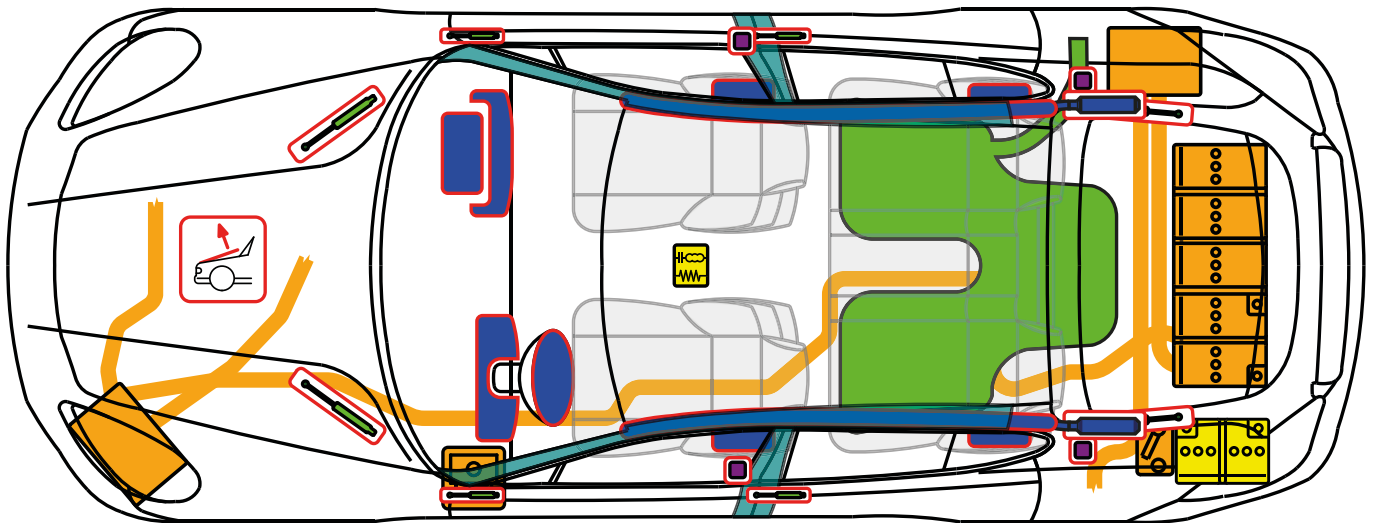

	Airbag		Body reinforcement		SRS-Control unit		High voltage battery
	Gas generator		Gas strut		12-volt Battery		High voltage cable / component
	Seat belt pretensioner		Pedestrian protection system		Fuse box		High voltage cut-off
	Fuel tank		Roll-over protection		Condenser		

Vehicle identification and marking

Panamera S Hybrid identification features – standard equipment

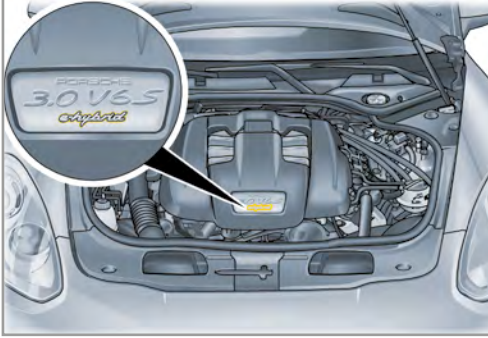

“e-hybrid” logo on the **engine cover**

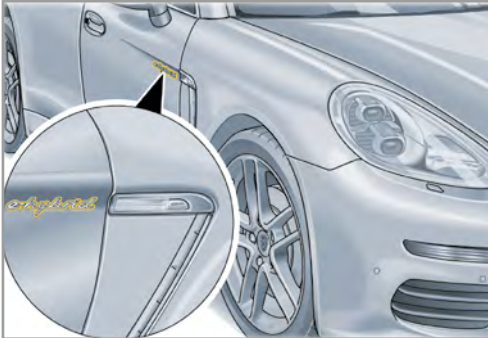

“e-hybrid” logo on the **right- and left-hand doors**

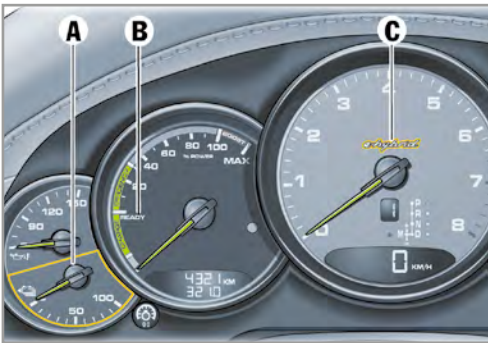

On the **instrument cluster**

A = battery charge state,
B = E-Power meter indicator,
C = “e-hybrid” logo

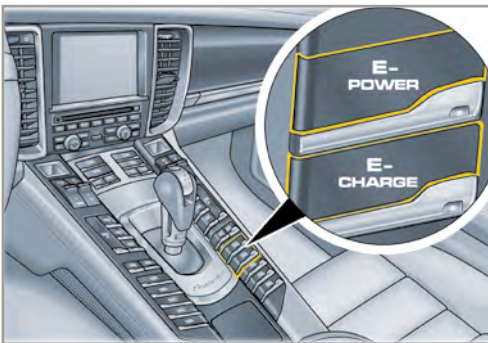

E-POWER and E-CHARGE buttons
on the center console

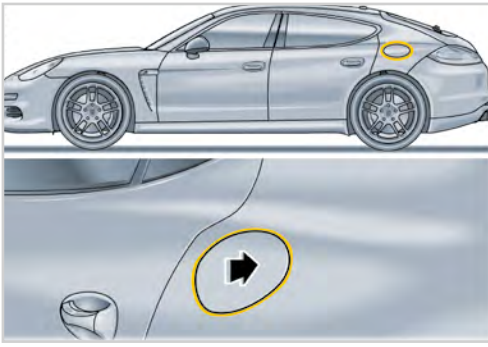

Vehicle charging connection behind the charging-socket lid on rear left side of the vehicle

Marking of the hybrid components



All high-voltage components are clearly marked with warning labels.

All high-voltage cables have orange insulation.

Safety information about the hybrid system

Undamaged plugs, cables and sockets in the on-board high-voltage system are safe to touch.



Risk of serious or fatal injury from electric shock if handled incorrectly!

If high-voltage components are not handled correctly, there is a risk of fatal injury.

- Do not touch high-voltage components that are in operation.
- Do not damage the orange high-voltage cables in the on-board high-voltage system.
- There may still be voltage in the high-voltage battery even after the on-board high-voltage system has been switched off. The high-voltage battery must not be damaged or opened.

Switching off the passive safety system and high-voltage system

⚠ WARNING The electric motor is silent when stationary!

You cannot always tell from the operating noise whether the car is ready to start because the electric motor is silent when stationary.

- The vehicle may be ready to start even when no engine noises can be heard.
- If the ignition is switched on, the combustion engine may start automatically depending on the level of charge of the high-voltage battery.

NOTE Deactivating the HV system

The high-voltage system switches off automatically in accidents where the airbags or seat belt pre-tensioners are activated.

To make sure that the **high-voltage system** is deactivated, it is recommended – depending on accessibility – to use the **primary or secondary emergency disconnection point as the deactivation method:**

1. Primary emergency disconnection point: Switch ignition key to “OFF” and unplug the 12-volt service plug in the rear luggage compartment.
2. Secondary emergency disconnection point: Switch ignition key to “OFF” and pull out fuse number 46 in the front left fuse box.

Other deactivation methods as described in the manual may only be performed by appropriately qualified personnel.

NOTE Deactivating the passive safety systems

The following steps should be taken to make sure that the **passive safety systems** (airbags and seat belt pre-tensioners) are switched off:

1. Disconnect the 12-volt battery in the driver’s footwell. The waiting time after disconnection of the 12-volt battery is 1 minute.
2. Switch off the high-voltage system via the primary or secondary emergency disconnection point to ensure there is no voltage in the on-board 12-volt battery network.

Deactivating the high-voltage system

Switching off the ignition

The method of switching off the high-voltage system described below applies to both vehicles with a conventional key and those with Porsche Entry & Drive (keyless entry system).

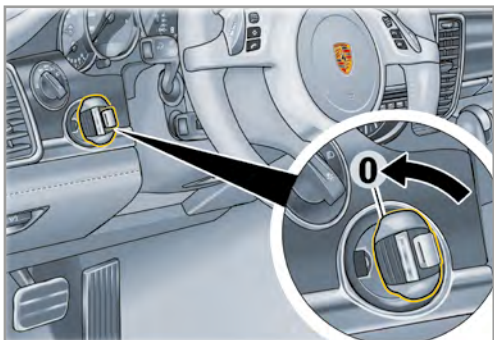

1. Turn the ignition key to “OFF” (0 position).

Primary emergency disconnection point: unplugging the 12-volt service plug in the rear luggage compartment

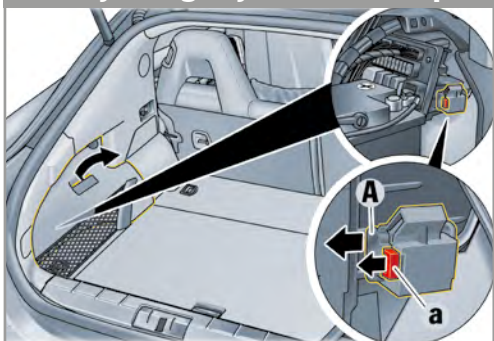

1. Unplug the 12-volt service plug.
2. Unlock -a- and unplug -A- the service plug.

- There is no voltage in the high-voltage system approx. 20 seconds after it has been switched off.
- The passive safety systems, such as airbags and seat belt pre-tensioners, are still supplied with voltage from the on-board 12-volt battery.

Secondary emergency disconnection point: removing fuse number 46 from the fuse box on the left-hand side of the dashboard

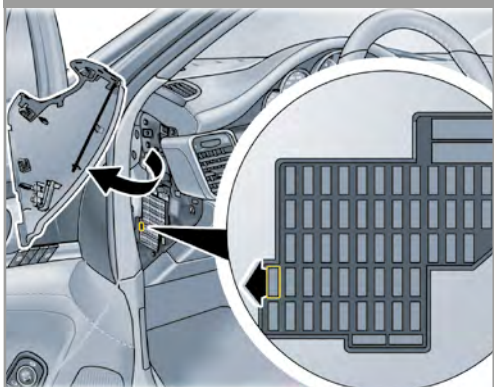

1. Open the lid of the fuse box on the left-hand side of the dashboard.
2. Pull out fuse number **46**.

- There is no voltage in the high-voltage system approx. 20 seconds after it has been switched off.
- The passive safety systems, such as airbags and seat belt pre-tensioners, are still supplied with voltage from the on-board 12-volt battery.

Deactivating the passive safety systems

Disconnecting the 12-volt battery

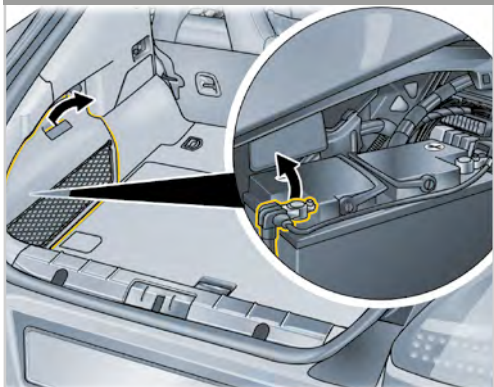

1. Ensure that no jumper cables are connected to the vehicle.
2. Remove the cover of the 12-volt battery on the rear left-hand side of the luggage compartment.
3. Disconnect the negative cable of the 12-volt battery and secure it to prevent accidental contact.

- Additionally deactivate the HV system at an emergency disconnection point.
- The passive safety systems (airbags and seat belt pre-tensioners) are deactivated. The waiting time after disconnection of the 12-volt battery is 1 minute.

Other accident situations

Vehicle in water

There is no risk that the car body will be live. Once the vehicle has been recovered:

1. Allow the water to run out of the interior.
2. Begin switching off the high-voltage system.

Vehicle/battery fire

Suitable extinguishing agent:

water (H₂O), larger quantities to cool the lithium ion battery

Battery fire

Suitable extinguishing agent for a battery fire:

dry sand, carbon dioxide (CO₂)

WARNING Battery cells explode when hot!

Battery modules might explode if the high-voltage battery becomes too hot.

→ Keep to the required safety distances when fighting the fire.



**Porsche AG, Boxter/S/GTS (981)
Cabriolet
from Model Year 2012**

PORSCHE

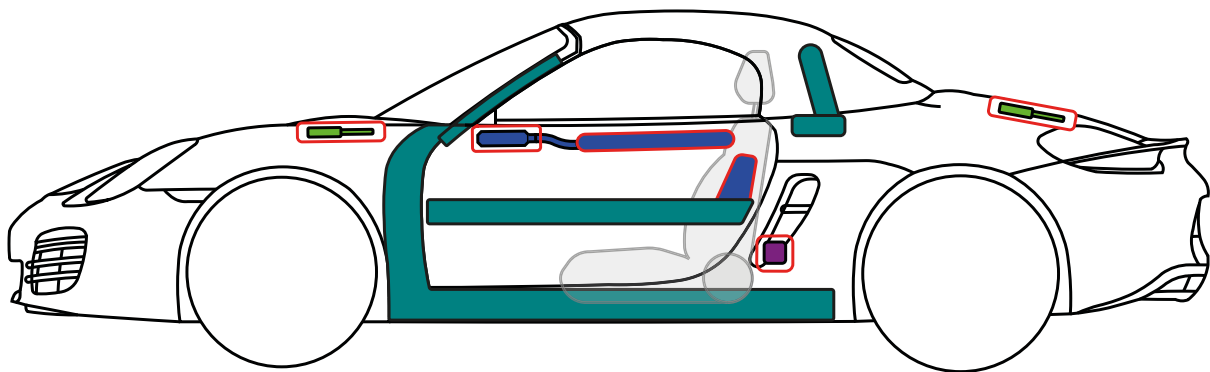
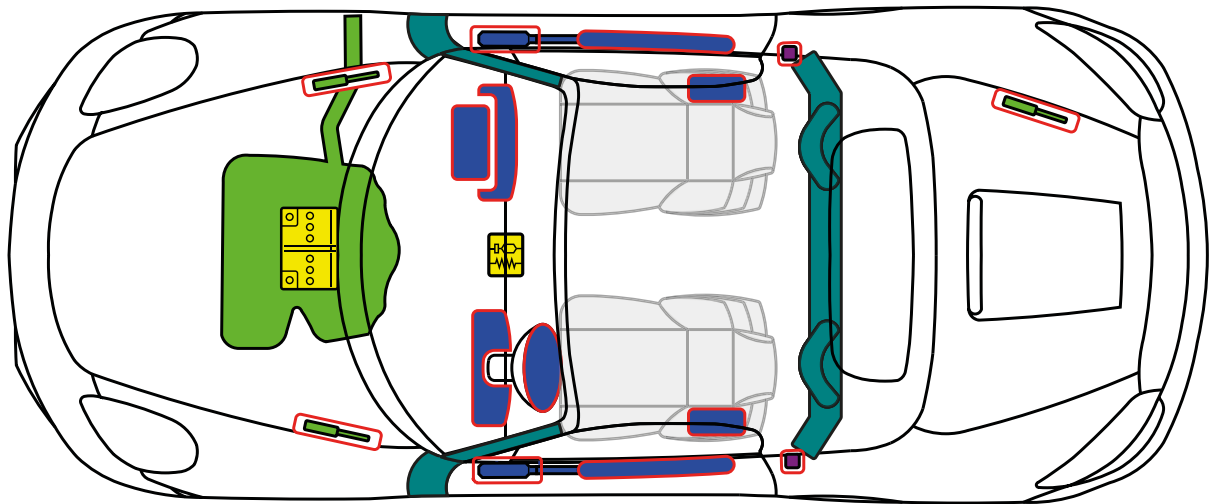

	Airbag		Body reinforcement		SRS-Control unit		High voltage battery
	Gas generator		Gas strut		12-volt Battery		High voltage cable / component
	Seat belt pretensioner		Pedestrian protection system		Fuse box		High voltage cut-off
	Fuel tank		Roll-over protection		Condenser		



Porsche AG, Cayman/S/GTS/GT4 (981)

Coupé

from Model Year 2014

PORSCHE

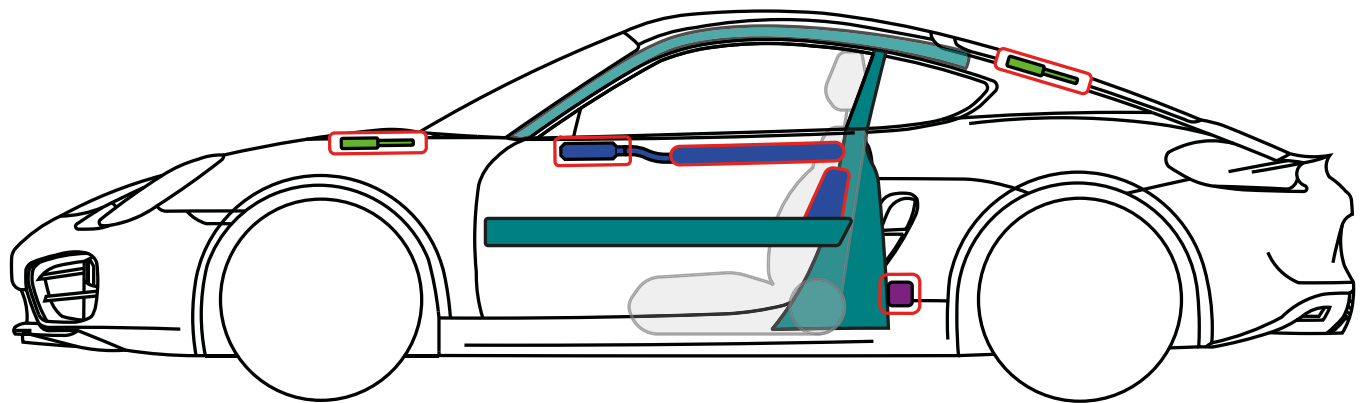
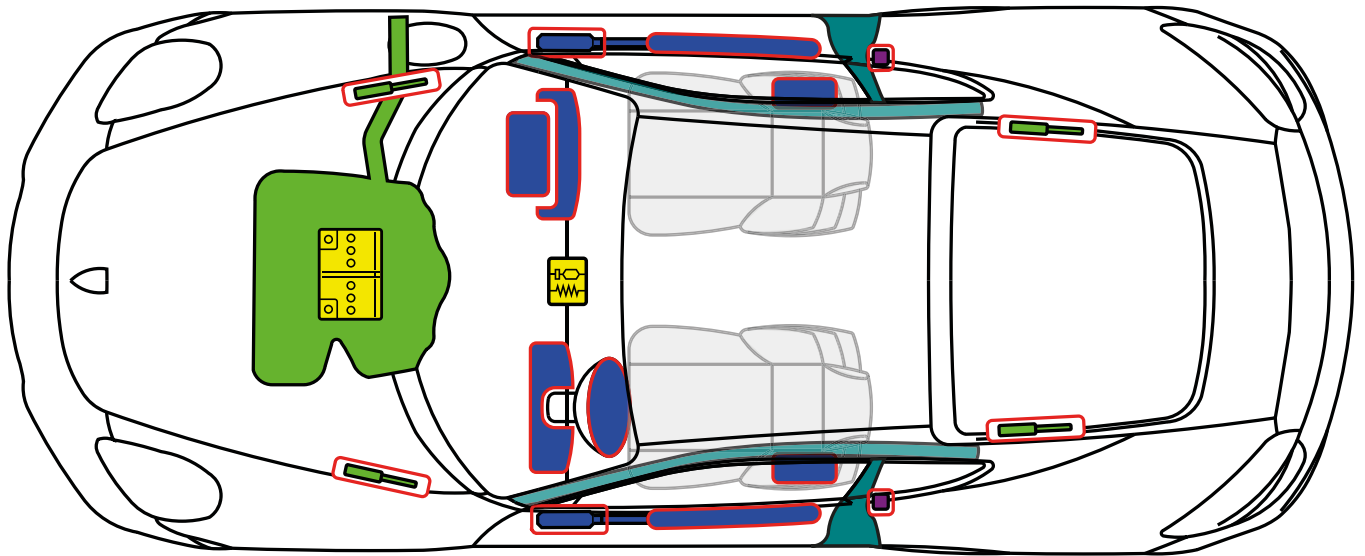

	Airbag		Body reinforcement		SRS-Control unit		High voltage battery
	Gas generator		Gas strut		12-volt Battery		High voltage cable / component
	Seat belt pretensioner		Pedestrian protection system		Fuse box		High voltage cut-off
	Fuel tank		Roll-over protection		Condenser		



PORSCHE

Porsche AG, Boxter Spyder (981) Cabriolet from Model Year 2015

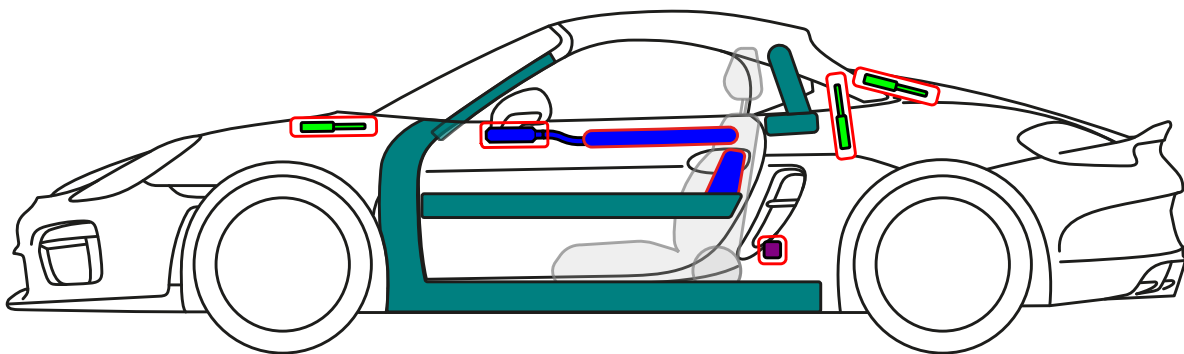
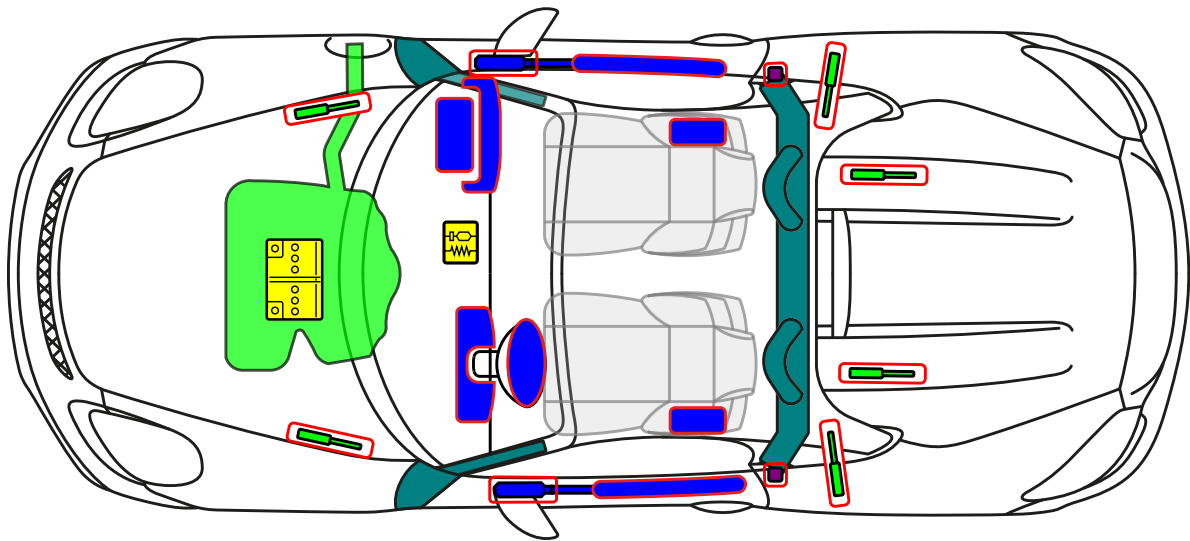

	Airbag		Body reinforcement		SRS-Control unit		High voltage battery
	Gas generator		Gas strut		12-volt Battery		High voltage cable / component
	Seat belt pretensioner		Pedestrian protection system		Fuse box		High voltage cut-off
	Fuel tank		Roll-over protection		Condenser		



PORSCHE

Porsche AG, Macan/S/GTS/S Diesel/Turbo (95B)
SUV
from Model Year 2014

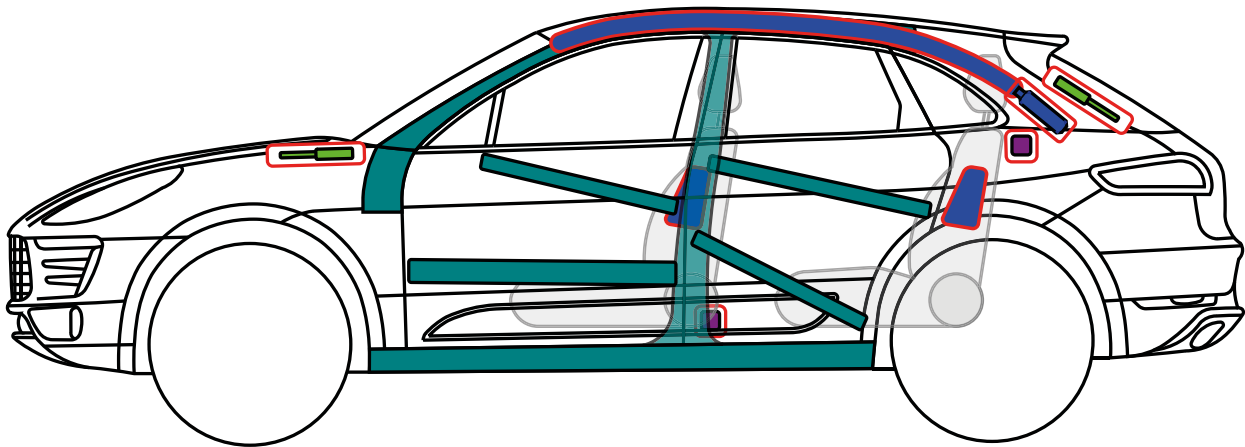
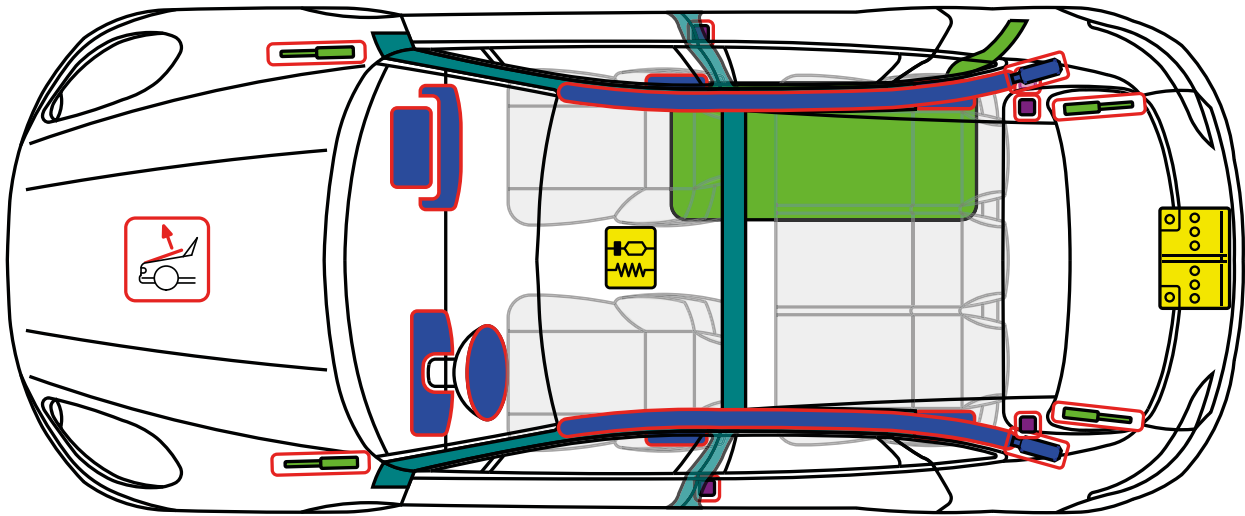



**Porsche AG, 918 Spyder (918)
Cabriolet
from Model Year 2014**

PORSCHE

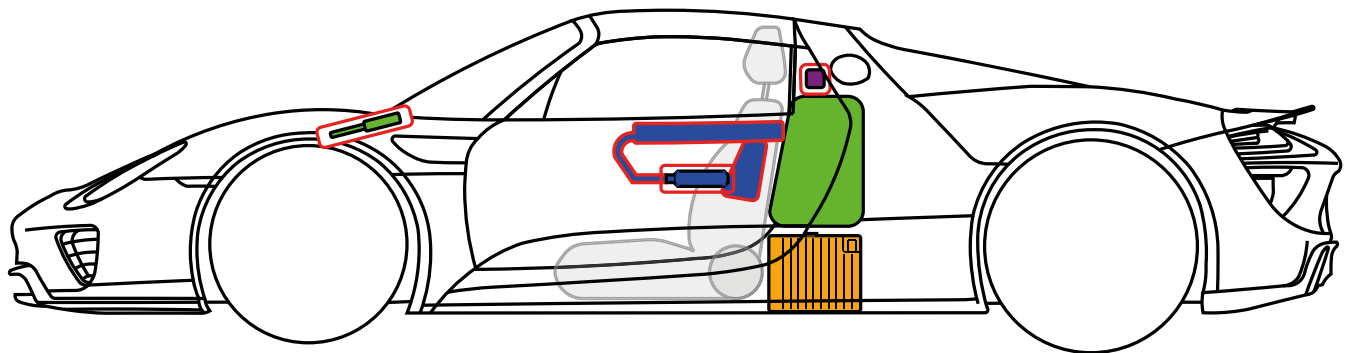
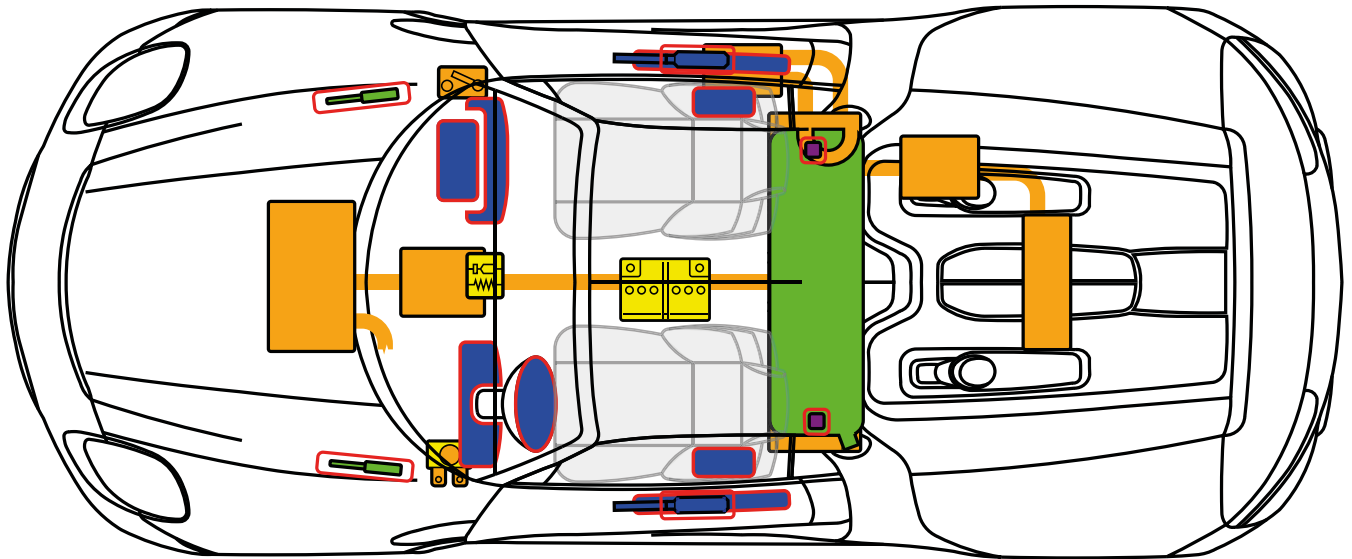

	Airbag		Body reinforcement		SRS-Control unit		High voltage battery
	Gas generator		Gas strut		12-volt Battery		High voltage cable / component
	Seat belt pretensioner		Pedestrian protection system		Fuse box		High voltage cut-off
	Fuel tank		Roll-over protection		Condenser		

NOTE

Body

- The complete body is made of carbon fiber-reinforced plastic (CFRP).
- No conventional body reinforcements are used.

Vehicle identification and marking

Identifying features of the 918 Spyder - standard equipment

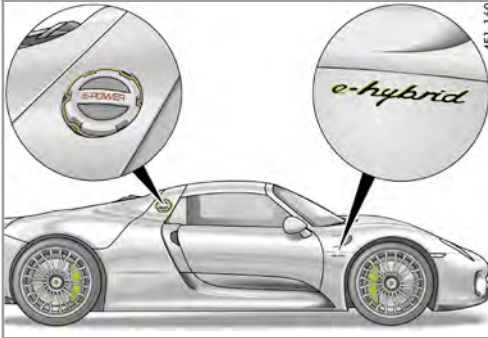

The 918 Spyder is manufactured and supplied exclusively as a plug-in hybrid.

“e-hybrid” logo on the fender at the left and right.

Vehicle charge port with “E-POWER” logo behind the charge port door on the rear right of the vehicle.

Marking of the hybrid components



All high-voltage components are clearly marked with warning stickers.

Orange insulation is used on all high-voltage lines.

Safety information about the hybrid system

Undamaged plugs, connectors, cables and sockets in the high-voltage vehicle electrical system are safe to touch.



Risk of serious or fatal injury from electric shock if handled incorrectly!

If high-voltage components are not handled correctly, there is a risk of fatal injury from high voltage and the possible flow of current through the human body.

- Do not touch high-voltage components that are in operation.
- Do not damage the orange high-voltage lines in the high-voltage vehicle electrical system.
- There may still be voltage in the high-voltage battery even after the high-voltage vehicle electrical system has been deactivated. The high-voltage battery must not be damaged or opened.

Deactivating the high-voltage system and passive safety system

⚠ WARNING The electric motor is silent when stationary!

You cannot always tell from the operating noise whether the vehicle is ready to start because the electric motor is silent when stationary.

- The vehicle may be ready to start even when no engine noises can be heard.
- If the ignition is switched on, the combustion engine may start automatically depending on the state of charge of the high-voltage battery.

NOTE Deactivating the HV system

The high-voltage system switches off automatically in the event of accidents where the airbags or seat-belt pretensioners are triggered.

To make sure that the **high-voltage system** is deactivated, it is recommended – depending on accessibility – to use the **primary or secondary emergency disconnection point as the deactivation method:**

1. Primary emergency disconnection point: Turn ignition key to “OFF” and unplug the 12-volt service plug at the right in the passenger’s footwell.
2. Secondary emergency disconnection point: Turn ignition key to “OFF” and remove fuse number B-6 (7.5 A) “Terminal 30 – HV battery control unit” from the fuse box at the left in the driver’s footwell.

Other deactivation methods as described in the Workshop Manuals may only be performed by appropriately qualified personnel.

NOTE Deactivating the passive safety systems

The probability of incorrect triggering of the passive safety systems (airbag and seat-belt pretensioner) is reduced by removing fuse C-4 from the fuse box in the passenger’s footwell (fuse for airbag control unit). The waiting time after removing fuse C-4 is 1 minute.

To make sure that the passive safety systems (airbag and seat-belt pretensioner) are **completely** deactivated, the 12-volt battery in the vehicle tunnel must be disconnected. The waiting time after disconnection of the 12-volt battery is 1 minute.

Deactivating the high-voltage system

Switching off the ignition

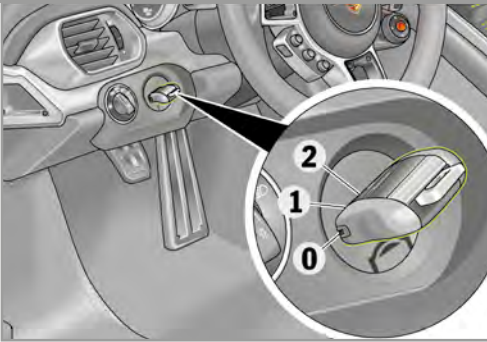

1. Turn the ignition key to “OFF” (position -0-).

Primary emergency disconnection point: Unplugging the 12-volt service plug at the right in the passenger’s footwell

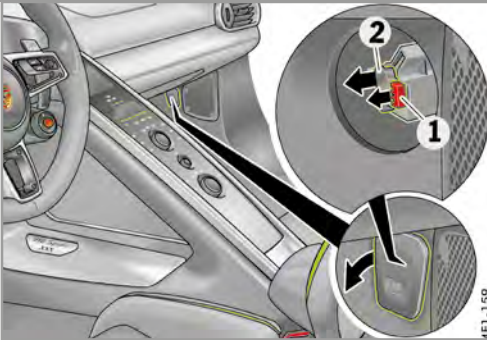

1. Open the cover on the 12-volt service plug at the right in the passenger’s footwell.
2. Release service plug “1”.
Press the release hook back slightly and unlock the service plug “2”.

- There is no voltage in the high-voltage system approx. 20 seconds after it has been deactivated.
- The passive safety systems, such as airbags and seat-belt pretensioners, are still supplied with voltage from the on-board 12-volt battery.

Secondary emergency disconnection point: Removing fuse B-6 from the fuse box at the left in the driver’s footwell

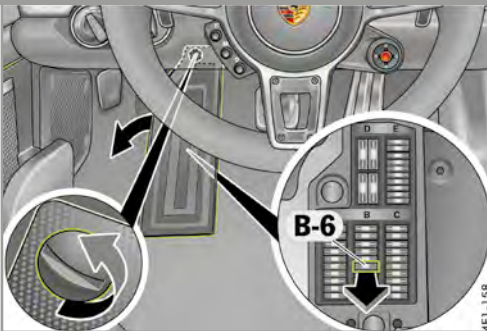

1. Open the cover on the fuse box at the left in the driver’s footwell.
2. Pull out fuse number **B-6**.

- There is no voltage in the high-voltage system approx. 20 seconds after it has been deactivated.
- The passive safety systems, such as airbags and seat-belt pretensioners, are still supplied with voltage from the on-board 12-volt battery.

Deactivating the passive safety systems

Removing fuse C-4 from the fuse box in the passenger's footwell

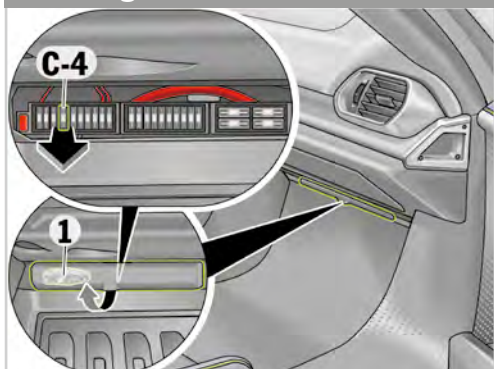

1. Loosen plastic clip “1” and open the cover on the fuse box in the passenger’s footwell.
2. Pull out fuse number **C-4**.

Disconnecting the 12-volt battery

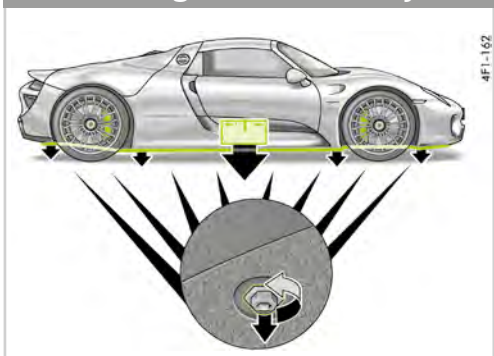

1. Make sure that no jumper cables are connected to the vehicle.
2. Remove underbody paneling and the cover of the 12-volt battery in the vehicle tunnel.
3. Disconnect the negative cable of the 12-volt battery and secure it to prevent accidental contact.

- ➔ There is no voltage in the high-voltage system approx. 20 seconds after it has been deactivated.
- ➔ The passive safety systems, such as airbags and seat-belt pretensioners, are still supplied with voltage from the on-board 12-volt battery.

Other accident situations

Vehicle in water

There is no risk that the vehicle body will be live. Once the vehicle has been recovered:

1. Allow the water to run out of the interior.
2. Start deactivating the high-voltage system.

Vehicle fire

Suitable extinguishing agent:

water (H₂O), larger quantities for cooling lithium ion batteries.

Battery fire

Alternative extinguishing agents for a battery fire:

dry sand, carbon dioxide (CO₂)

⚠ WARNING Battery modules explode when hot!

Battery modules might explode if the high-voltage battery becomes too hot.

→ Observe the required safety distances when fighting the fire.



**Porsche AG, Boxster/S (718)
Cabriolet
from Model Year 2016**

PORSCHE

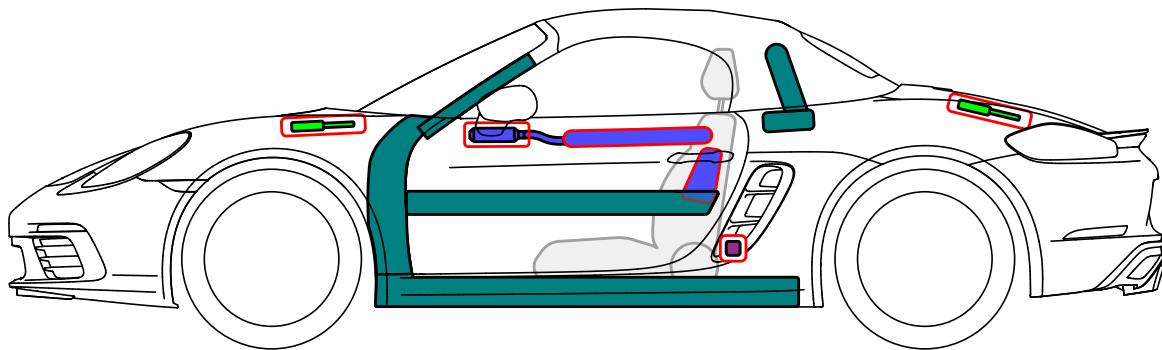
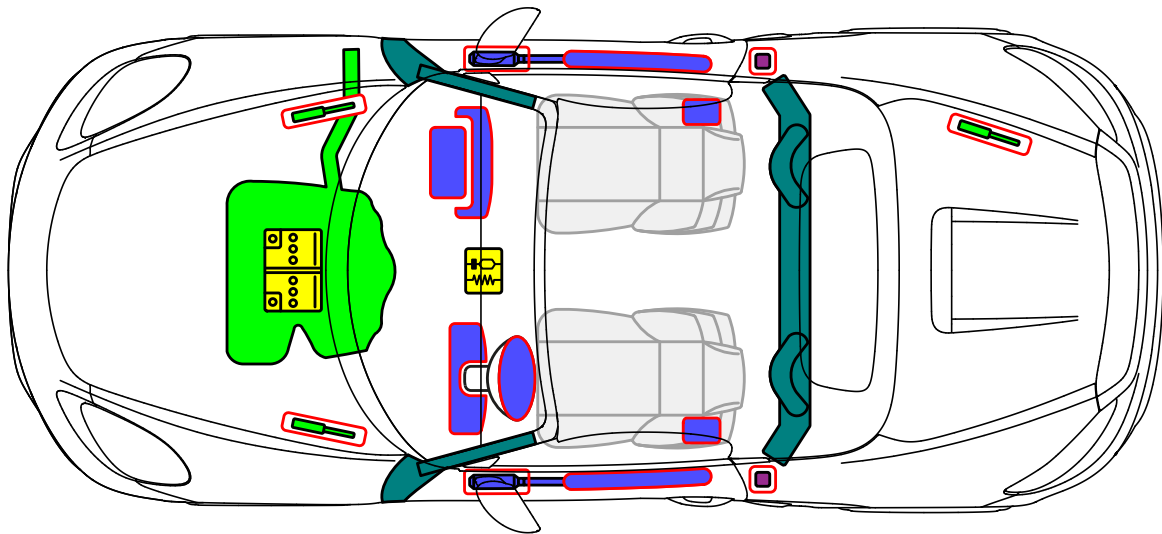

	Airbag		Body reinforcement		SRS-Control unit		High voltage battery
	Gas generator		Gas strut		12-volt Battery		High voltage cable / component
	Seat belt pretensioner		Pedestrian protection system		Fuse box		High voltage cut-off
	Fuel tank		Roll-over protection		Condenser		



**Porsche AG, 911 R (991)
Coupé
from Model Year 2016**

PORSCHE

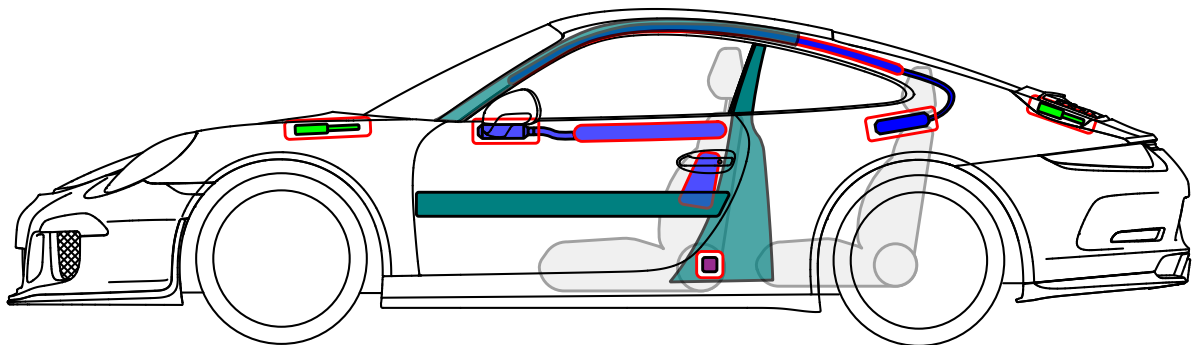
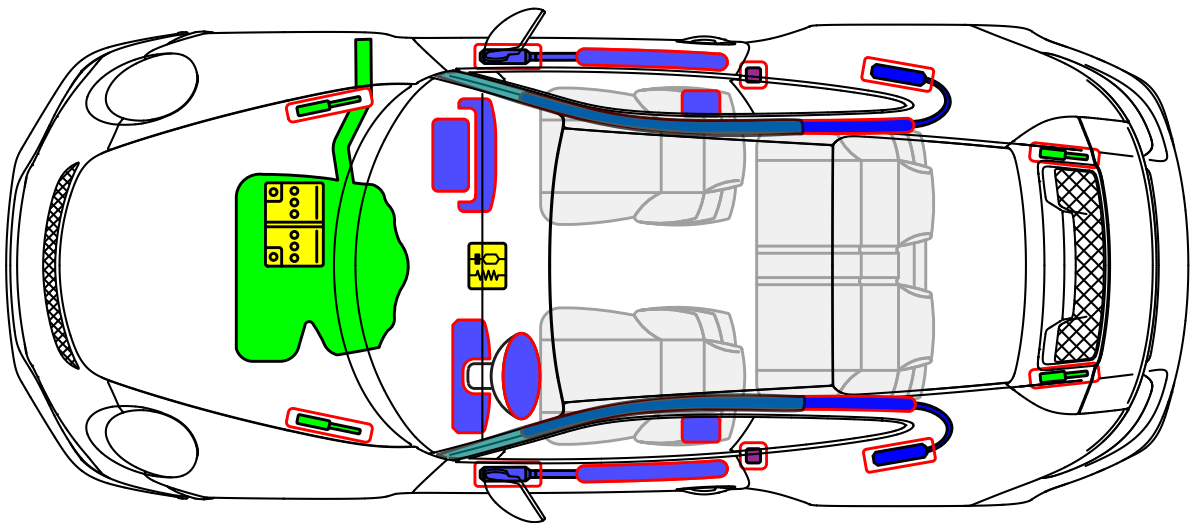



Porsche AG, Cayman/S (718) Coupé from Model Year 2016

PORSCHE

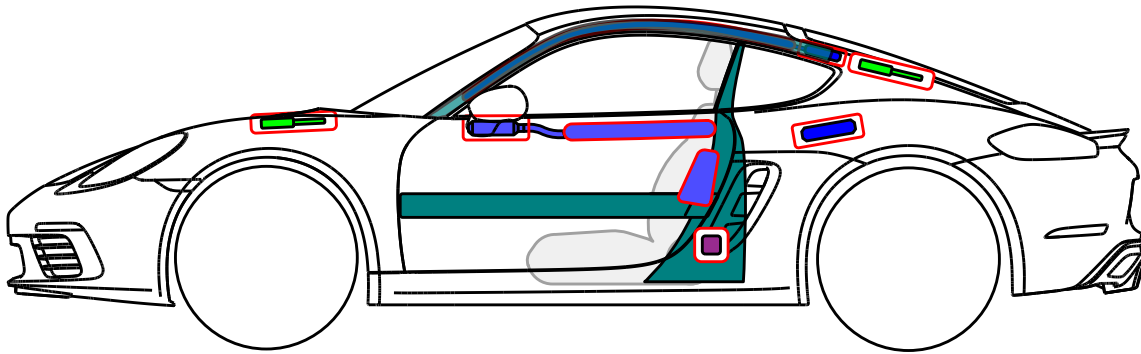
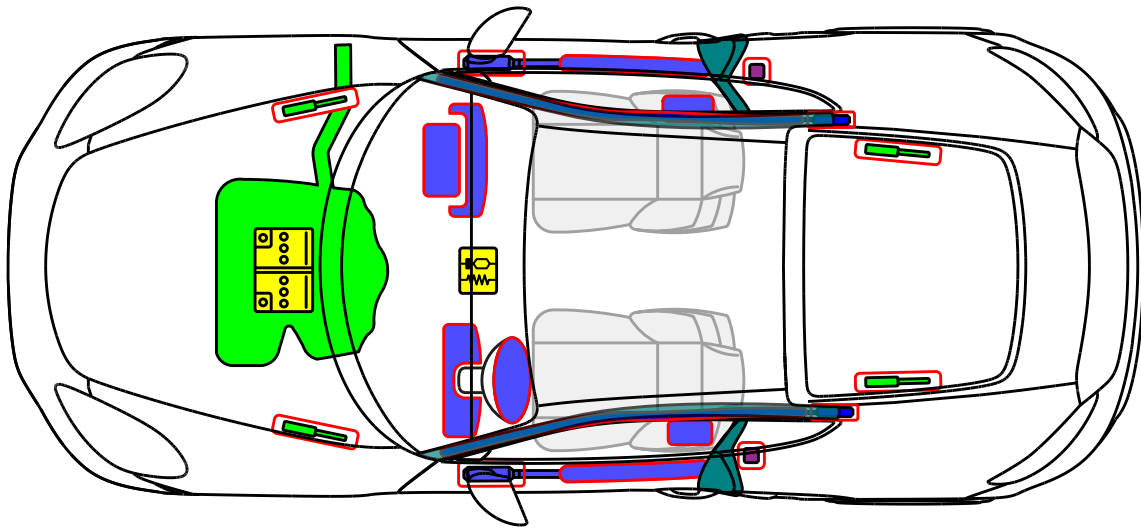



PORSCHE

Porsche AG, Panamera (971) all derivatives (excl. E-Hybrid), Sedan from Model Year 2016

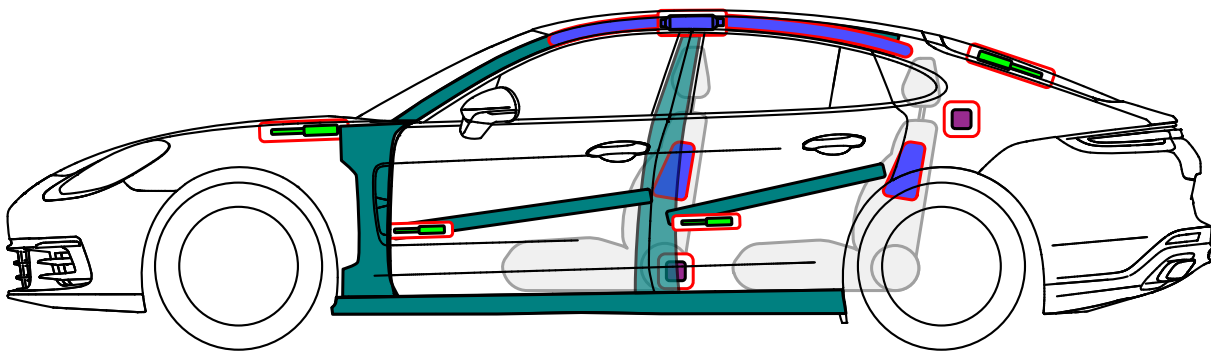
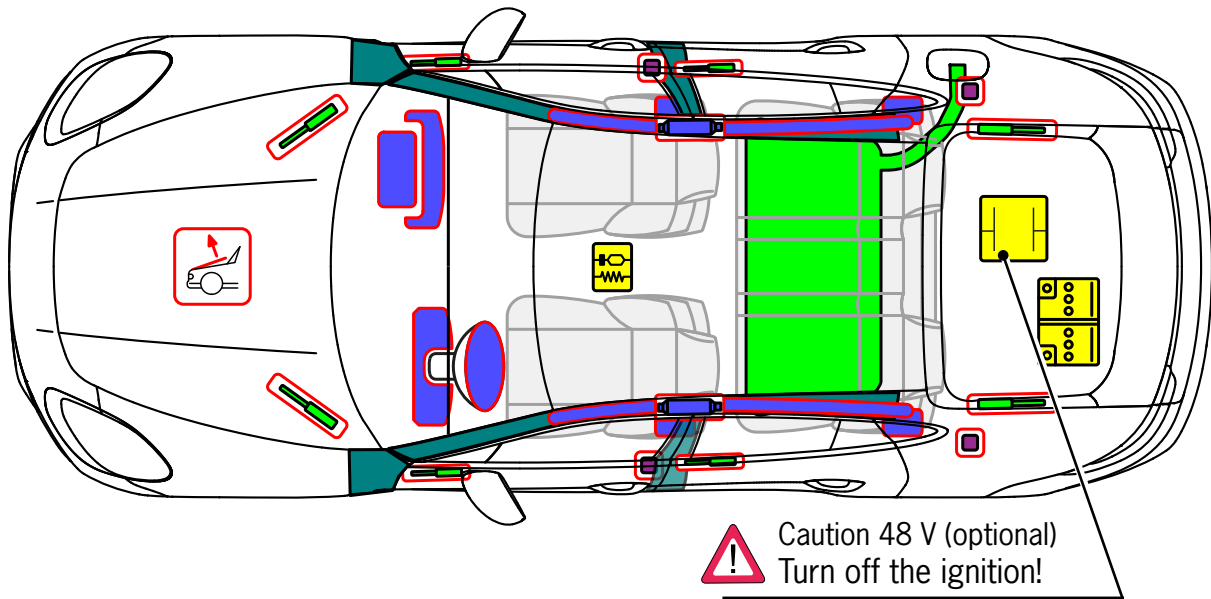

	Airbag		Body reinforcement		SRS-Control unit		High voltage battery
	Gas generator		Gas strut		12-volt Battery		High voltage cable / component
	Seat belt pretensioner		Pedestrian protection system		Fuse box		High voltage cut-off
	Fuel tank		Roll-over protection		Condenser		



**Porsche AG, Panamera (971) S/Turbo S E-Hybrid
Sedan
from Model Year 2016**

PORSCHE

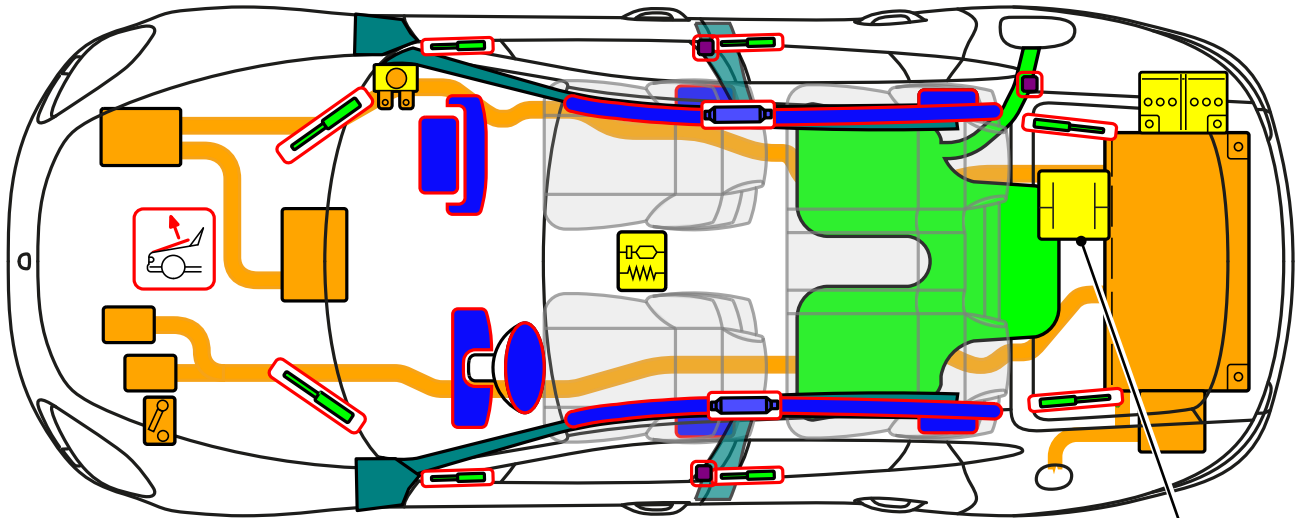

**Caution 48 V (optional)
Turn off the ignition!**

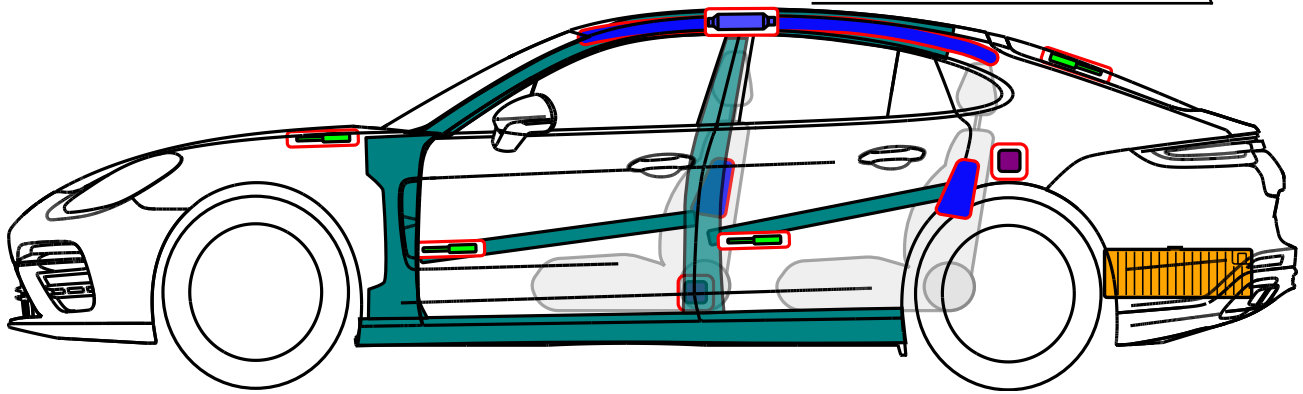

	Airbag		Body reinforcement		SRS-Control unit		High voltage battery
	Gas generator		Gas strut		12-volt Battery		High voltage cable / component
	Seat belt pretensioner		Pedestrian protection system		Fuse box		High voltage cut-off
	Fuel tank		Roll-over protection		Condenser		

Vehicle identification and marking

Panamera S E-Hybrid identification features – standard equipment



“e-hybrid” logo on the **engine** cover

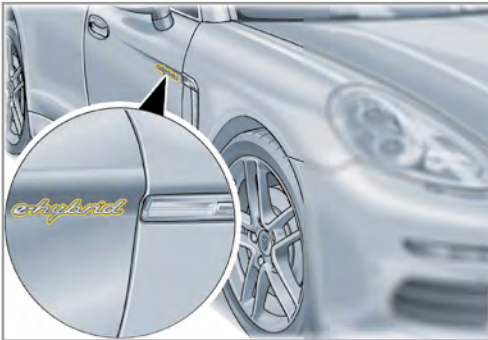

“e-hybrid” logo on the **right- and left-hand doors**

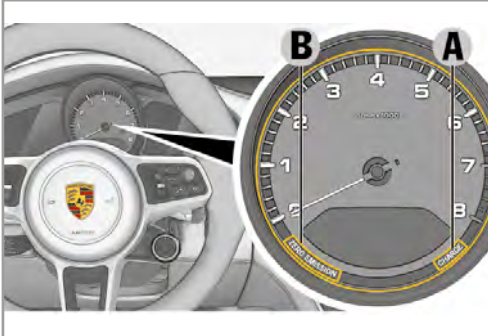

On the **instrument cluster**

B = “ZERO EMISSION”

A = “CHARGE”

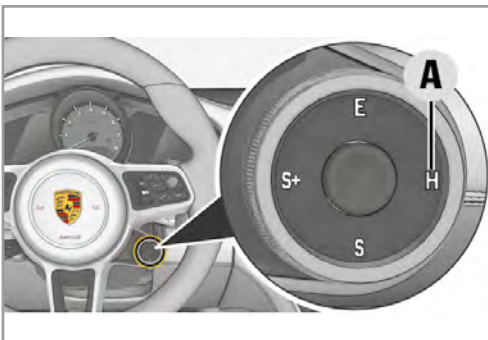

A = “H” labeling on the knob

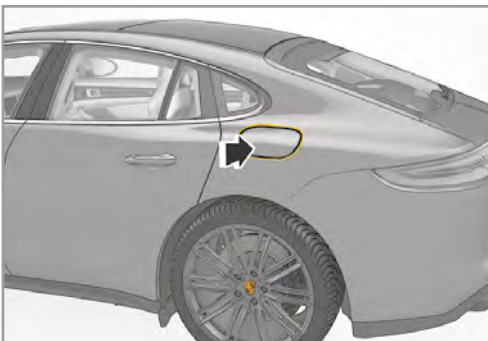

Vehicle charging connection behind the charging-socket lid on rear left side of the vehicle

Marking of the hybrid components

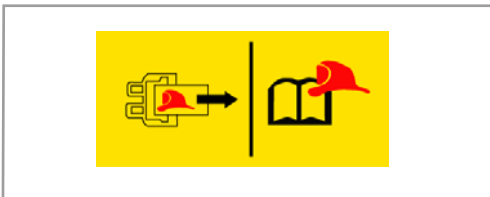
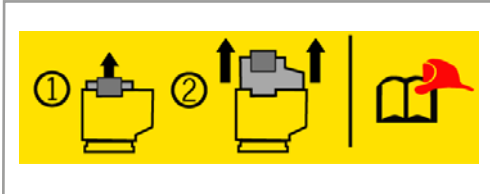

All high-voltage components and high-voltage disconnection points are clearly marked with warning/information stickers.

All high-voltage cables have orange insulation.

Safety information about the hybrid system

Undamaged plugs, cables and sockets in the on-board high-voltage system are safe to touch.

! DANGER

Risk of serious or fatal injury from electric shock if handled incorrectly!

If high-voltage components are not handled correctly, there is a risk of fatal injury.

- **Do not touch high-voltage components that are in operation.**
- Do not damage the orange high-voltage cables in the on-board high-voltage system.
- There may still be voltage in the high-voltage battery even after the on-board high-voltage system has been switched off. The high-voltage battery must not be damaged or opened.

Switching off the passive safety system and high-voltage system

⚠ WARNING The electric motor is silent when stationary!

You cannot always tell from the operating noise whether the car is ready to start because the electric motor is silent when stationary.

- The vehicle may be ready to start even when no engine noises can be heard.
- If the ignition is switched on, the combustion engine may start automatically depending on the level of charge of the high-voltage battery.

NOTE Deactivating the HV system

The high-voltage system switches off automatically in accidents where the airbags or seat belt pre-tensioners are activated.

To make sure that the **high-voltage system** is deactivated, it is recommended – depending on accessibility – to use the **primary or secondary emergency disconnection point as the deactivation method:**

1. Primary emergency disconnection point: Switch ignition to “OFF” and unplug the 12-volt service plug (marked with a flag) on the front left side in the engine compartment.
2. Secondary emergency disconnection point: Switch ignition to “OFF” and pull out fuse number 4 (marked with a flag) in the front right fuse box located in the front passenger footwell.

Other deactivation methods as described in the manual may only be performed by appropriately qualified personnel.

NOTE Deactivating the passive safety systems

To make sure that the **passive safety systems** (airbags and seat belt pre-tensioners) are deactivated,

1. the 12-volt battery in the luggage compartment should be disconnected. The waiting time after disconnection of the 12-volt battery is 1 minute.
2. the high-voltage system should be deactivated via the primary or secondary emergency disconnection point to ensure there is no voltage in the on-board 12-volt battery.

Deactivating the high-voltage system

Switching off the ignition

The method of switching off the high-voltage system described below applies to both vehicles with a conventional key and those with Porsche Entry & Drive (keyless entry system). In both cases, the ignition must be turned to “OFF” first.

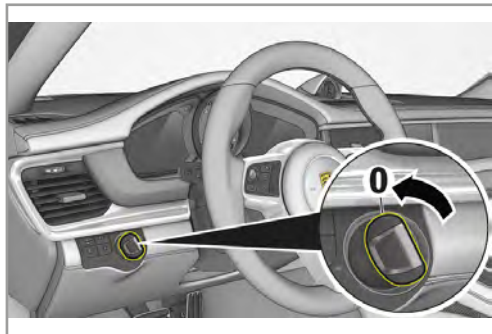

1. Turn the ignition to “OFF” (0 position).

Primary emergency disconnection point: unplugging the 12-volt service plug in the engine compartment at the front left

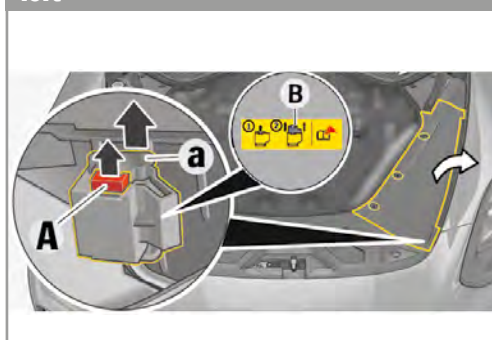

1. Remove the cover.
2. Unplug the 12-volt service plug.
3. Unlock -A- and unplug -a- the service plug (marked with a flag -B-).

- ➔ There is no voltage in the high-voltage system approx. 20 seconds after it has been switched off.
- ➔ The passive safety systems, such as airbags and seat belt pre-tensioners, are still supplied with voltage from the on-board 12-volt battery.

Secondary emergency disconnection point: removing the fuse from the fuse box of the front passenger footwell on the right

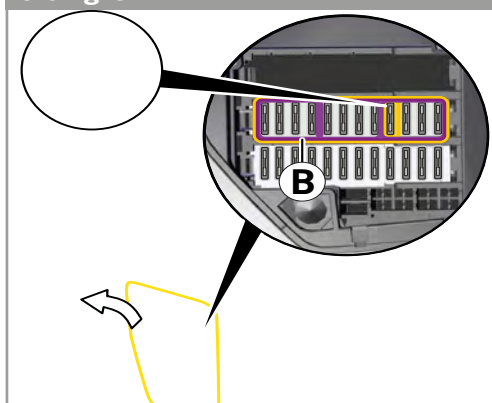

1. Open the lid of the fuse box in the front passenger footwell on the right.
2. Remove the retaining frame (B) from the fuse block.
3. Unplug fuse number 4 (marked with a flag A).

- ➔ There is no voltage in the high-voltage system approx. 20 seconds after it has been switched off.
- ➔ The passive safety systems, such as airbags and seat belt pre-tensioners, are still supplied with voltage from the on-board 12-volt battery.

Deactivating the passive safety systems

Disconnecting the 12-volt battery

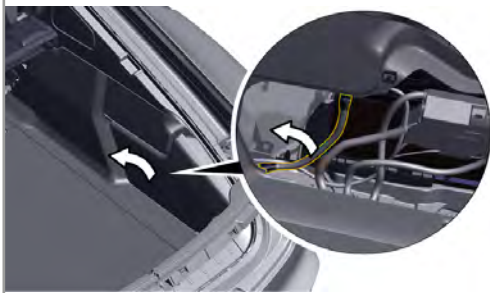

1. Ensure that no jumper cables are connected to the vehicle.
2. Remove the cover of the 12-volt battery on the rear right-hand side of the luggage compartment.
3. Disconnect the negative cable of the 12-volt battery and secure it to prevent accidental contact.

- There is no voltage in the high-voltage system approx. 20 seconds after it has been switched off.
- The passive safety systems (airbags and seat belt pre-tensioners) are deactivated. The waiting time after disconnection of the 12-volt battery is 1 minute.

Other accident situations

Vehicle in water

There is no risk that the car body will be live. Once the vehicle has been recovered:

1. Allow the water to run out of the interior.
2. Begin switching off the high-voltage system.

Vehicle/battery fire

Suitable extinguishing agent:

water (H₂O), larger quantities to cool the lithium ion battery

Battery fire

Suitable extinguishing agents for a battery fire:

dry sand, carbon dioxide (CO₂)

⚠ WARNING Battery cells explode when hot!

Battery modules might explode if the high-voltage battery becomes too hot.

- Keep to the required safety distances when fighting the fire.







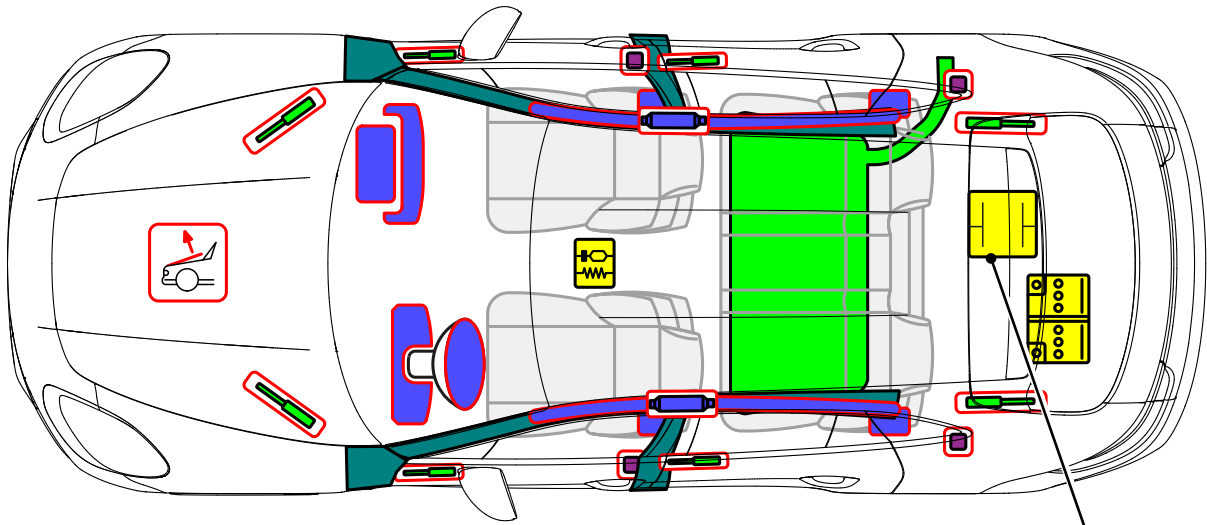



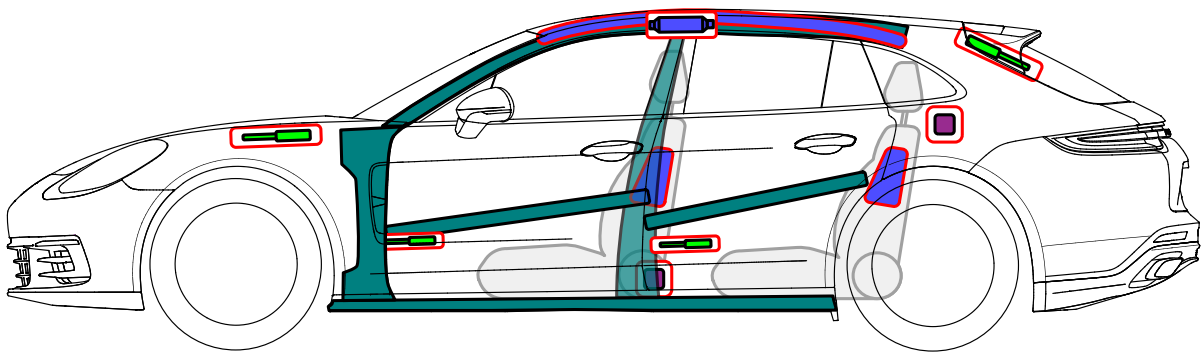







PORSCHE

Porsche AG, Panamera Sport Turismo (974) all derivatives (excl. E-Hybrid), Sport Turismo from Model Year 2017



 Caution 48 V (optional)
Turn off the ignition!



	Airbag		Body reinforcement		SRS-Control unit		High voltage battery
	Gas generator		Gas strut		12-volt Battery		High voltage cable / component
	Seat belt pretensioner		Pedestrian protection system		Fuse box		High voltage cut-off
	Fuel tank		Roll-over protection		Condenser		



Porsche AG, 911 GT2 RS (991)
Coupé
from Model Year 2017

PORSCHE

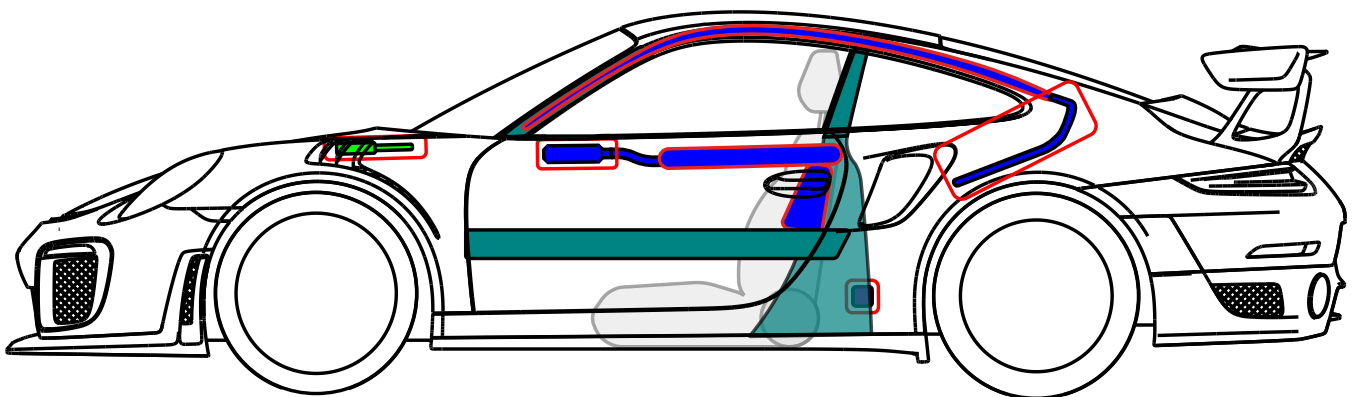
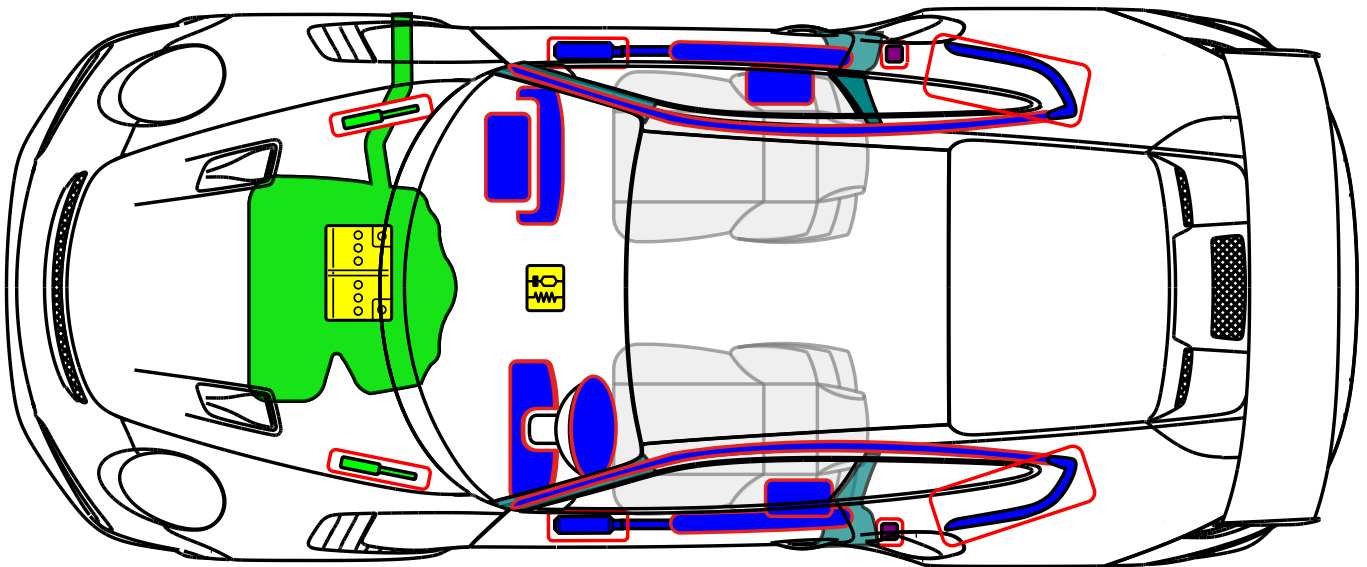

	Airbag		Body reinforcement		SRS-Control unit		High voltage battery
	Gas generator		Gas strut		12-volt Battery		High voltage cable / component
	Seat belt pretensioner		Pedestrian protection system		Fuse box		High voltage cut-off
	Fuel tank		Roll-over protection		Condenser		



PORSCHE

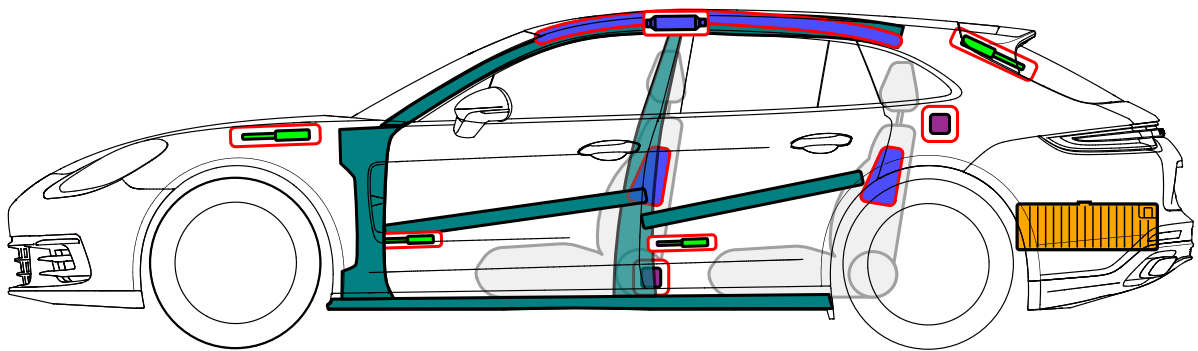
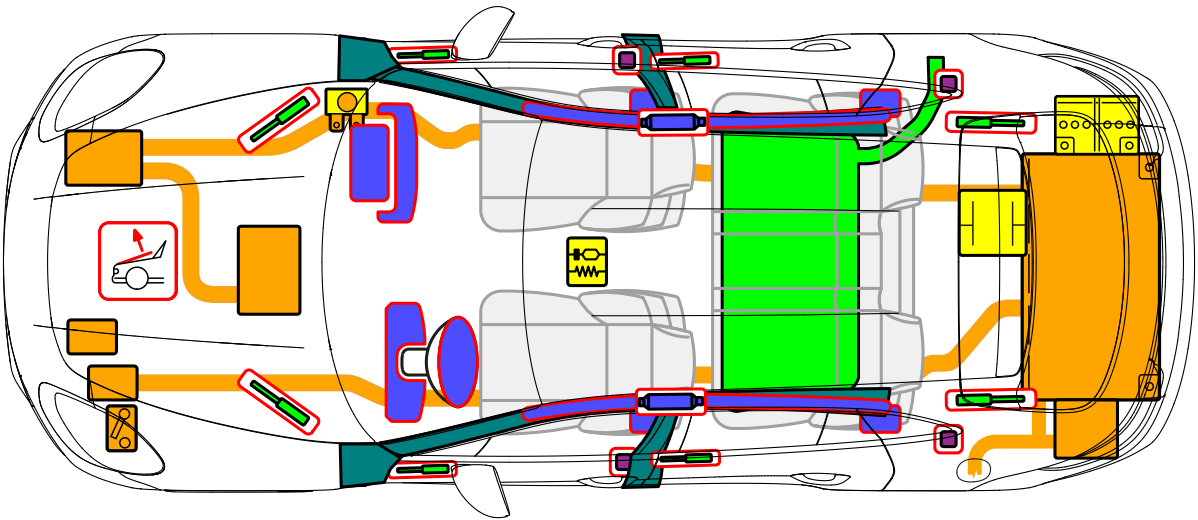

	Airbag		Body reinforcement		SRS-Control unit		High voltage battery
	Gas generator		Gas strut		12-volt Battery		High voltage cable / component
	Seat belt pretensioner		Pedestrian protection system		Fuse box		High voltage cut-off
	Fuel tank		Roll-over protection		Condenser		

Vehicle identification and marking

Panamera Sport Turismo E-Hybrid identification features – standard equipment



'e-hybrid' logo on the **engine cover**

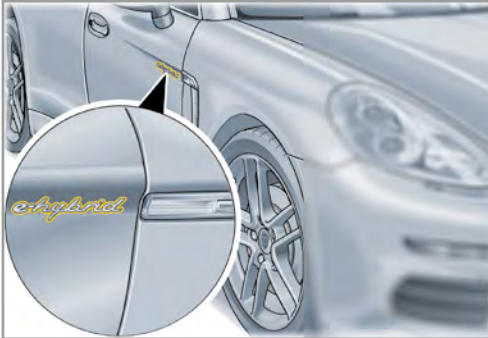

'e-hybrid' logo on the **right- and left-hand doors**

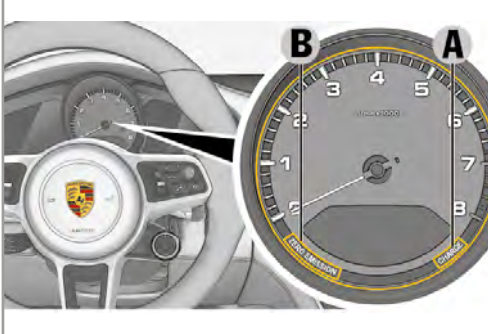

On the **instrument cluster**

B = 'ZERO EMISSION'

A = 'CHARGE'

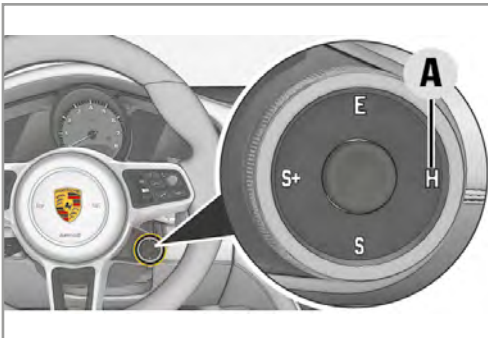

A = 'H' labelling on the knob

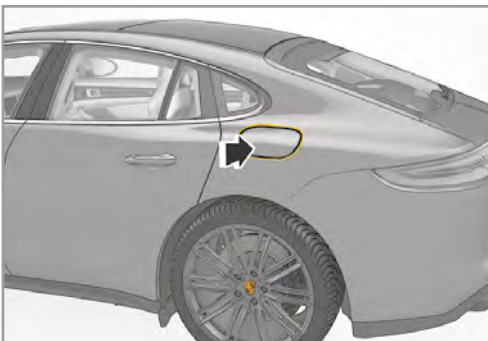

Vehicle charging connection behind the charging-socket lid on rear left side of the vehicle

Marking of the hybrid components

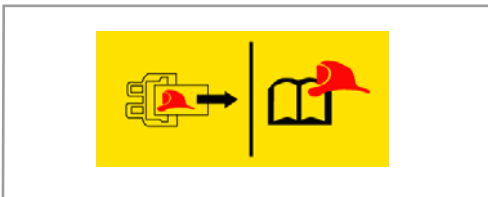
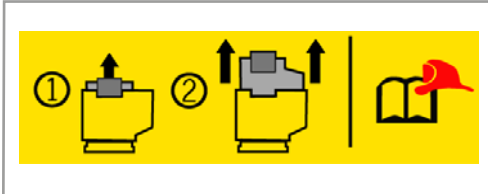

All high-voltage components and high-voltage disconnection points are clearly marked with warning/information stickers.

All high-voltage cables have orange insulation.

Safety information about the hybrid system

Undamaged plugs, connectors, cables and sockets in the on-board high-voltage system are safe to touch.



DANGER

Risk of serious or fatal injury from electric shock if handled incorrectly!

If high-voltage components are not handled correctly, there is a risk of fatal injury.

- **Do not touch high-voltage components that are in operation.**
- Do not damage the orange high-voltage cables in the on-board high-voltage system.
- There may still be voltage in the high-voltage battery even after the on-board high-voltage system has been switched off. The high-voltage battery must not be damaged or opened.

Switching off the passive safety system and high-voltage system

⚠ WARNING The electric motor is silent when stationary!

You cannot always tell from the operating noise whether the car is ready to start because the electric motor is silent when stationary.

- The vehicle may be ready to start even when no engine noises can be heard.
- If the ignition is switched on, the combustion engine may start automatically depending on the level of charge of the high-voltage battery.

NOTE Deactivating the HV system

The high-voltage system switches off automatically in accidents where the airbags or seat belt pre-tensioners are activated.

To make sure that the **high-voltage system** is deactivated, it is recommended – depending on accessibility – to use the **primary or secondary emergency disconnection point as the deactivation method:**

1. Primary emergency disconnection point: Switch ignition to 'OFF' and unplug the 12-volt service plug (marked with a flag) on the front left side in the engine compartment.
2. Secondary emergency disconnection point: Switch ignition to 'OFF' and pull out fuse number 4 (marked with a flag) in the front right fuse box located in the front passenger footwell.

Other deactivation methods as described in the manual may only be performed by appropriately qualified personnel.

NOTE Deactivating the passive safety systems

To make sure that the **passive safety systems** (airbags and seat belt pre-tensioners) are deactivated,

1. the 12-volt battery in the luggage compartment should be disconnected. The waiting time after disconnection of the 12-volt battery is 1 minute.
2. the high-voltage system should be deactivated via the primary or secondary emergency disconnection point to ensure there is no voltage in the on-board 12-volt battery.

Deactivating the high-voltage system

Switching off the ignition

The method of switching off the high-voltage system described below applies to both vehicles with a conventional key and those with Porsche Entry & Drive (keyless entry system). In both cases, the ignition must be turned to 'OFF' first.

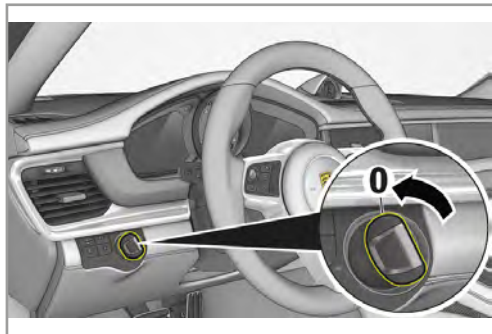

1. Turn the ignition to 'OFF' (0 position).

Primary emergency disconnection point: unplugging the 12-volt service plug in the engine compartment at the front left

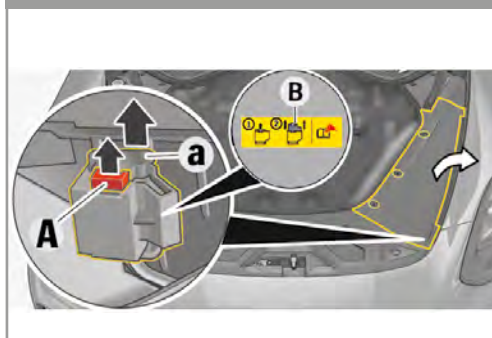

1. Remove the cover.
2. Unplug the 12-volt service plug.
3. Unlock -A- and unplug -a- the service plug (marked with a flag -B-).

- ➔ There is no voltage in the high-voltage system approx. 20 seconds after it has been switched off.
- ➔ The passive safety systems, such as airbags and seat belt pre-tensioners, are still supplied with voltage from the on-board 12-volt battery.

Secondary emergency disconnection point: removing the fuse from the fuse box of the front passenger footwell on the right

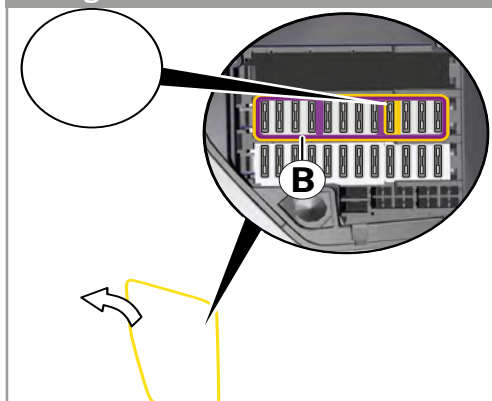

1. Open the lid of the fuse box in the front passenger footwell on the right.
2. Remove the retaining frame (B) from the fuse block.
3. Unplug fuse number 4 (marked with a flag A).

- ➔ There is no voltage in the high-voltage system approx. 20 seconds after it has been switched off.
- ➔ The passive safety systems, such as airbags and seat belt pre-tensioners, are still supplied with voltage from the on-board 12-volt battery.

Deactivating the passive safety systems

Disconnecting the 12-volt battery

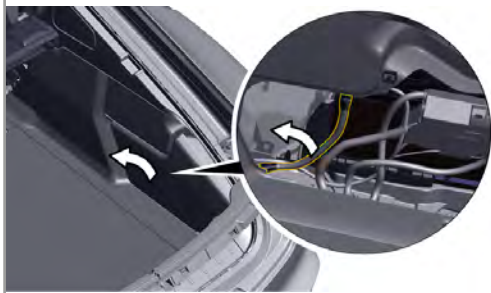

1. Ensure that no jump leads are connected to the vehicle.
2. Remove the cover of the 12-volt battery on the rear right-hand side of the luggage compartment.
3. Disconnect the negative cable of the 12-volt battery and secure it to prevent accidental contact.

- There is no voltage in the high-voltage system approx. 20 seconds after it has been switched off.
- The passive safety systems (airbags and seat belt pre-tensioners) are deactivated. The waiting time after disconnection of the 12-volt battery is 1 minute.

Other accident situations

Vehicle in water

There is no risk that the car body will be live. Once the vehicle has been recovered:

1. Allow the water to run out of the interior.
2. Begin switching off the high-voltage system.

Vehicle/battery fire

Suitable extinguishing agent:

water (H₂O), larger quantities to cool the lithium ion battery

Battery fire

Suitable extinguishing agents for a battery fire:

dry sand, carbon dioxide (CO₂)

⚠ WARNING Battery cells explode when hot!

Battery modules might explode if the high-voltage battery becomes too hot.

- Keep to the required safety distances when fighting the fire.



PORSCHE

Porsche AG, Cayenne (9AY) all derivatives (excl. E-Hybrid), SUV from Model Year 2017

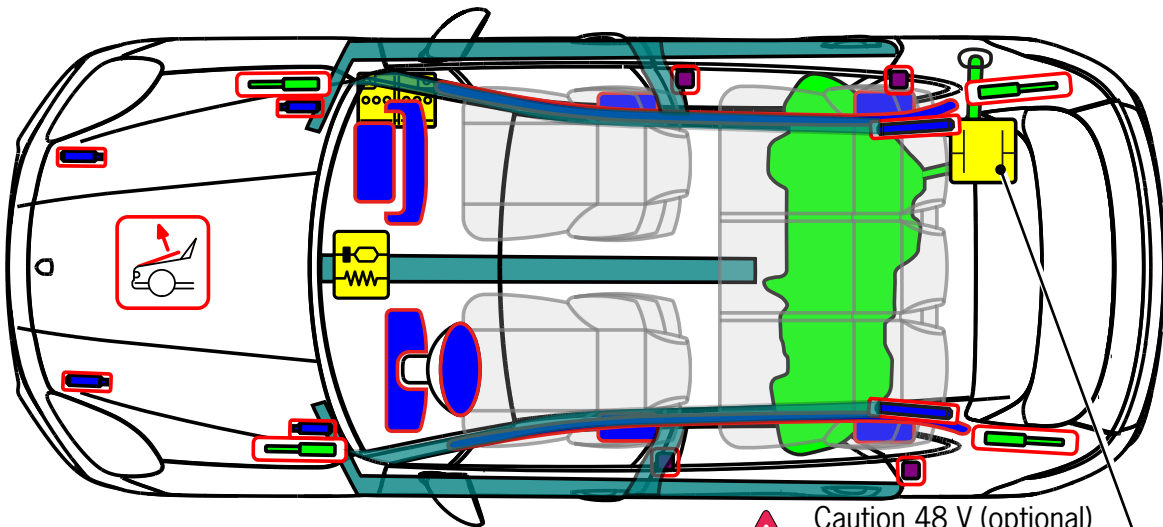

Caution 48 V (optional)
Turn off the ignition!

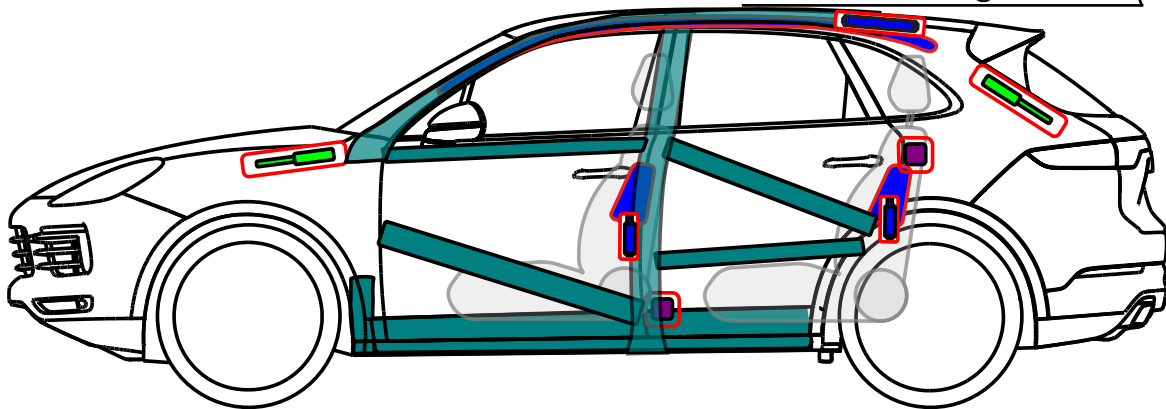

	Airbag		Body reinforcement		SRS-Control unit		High voltage battery
	Gas generator		Gas strut		12-volt Battery		High voltage cable / component
	Seat belt pretensioner		Pedestrian protection system		Fuse box		High voltage cut-off
	Fuel tank		Roll-over protection		Condenser		









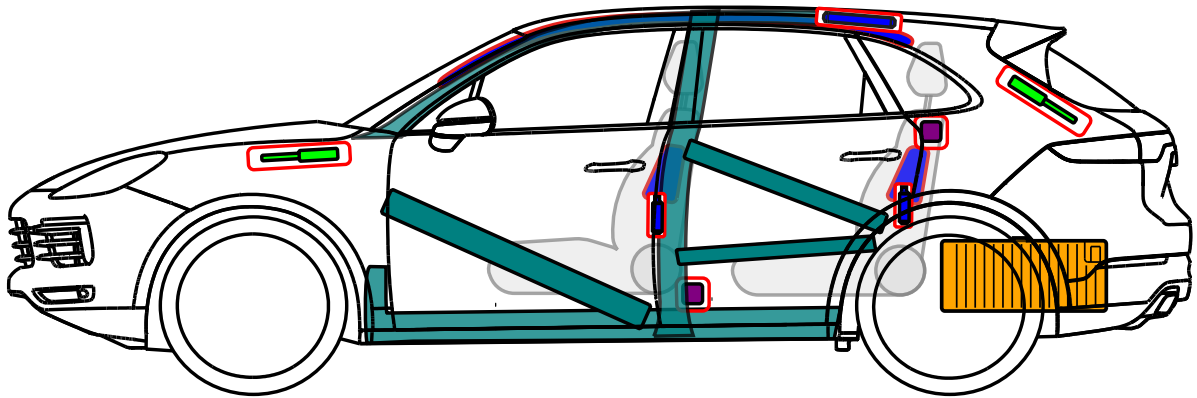
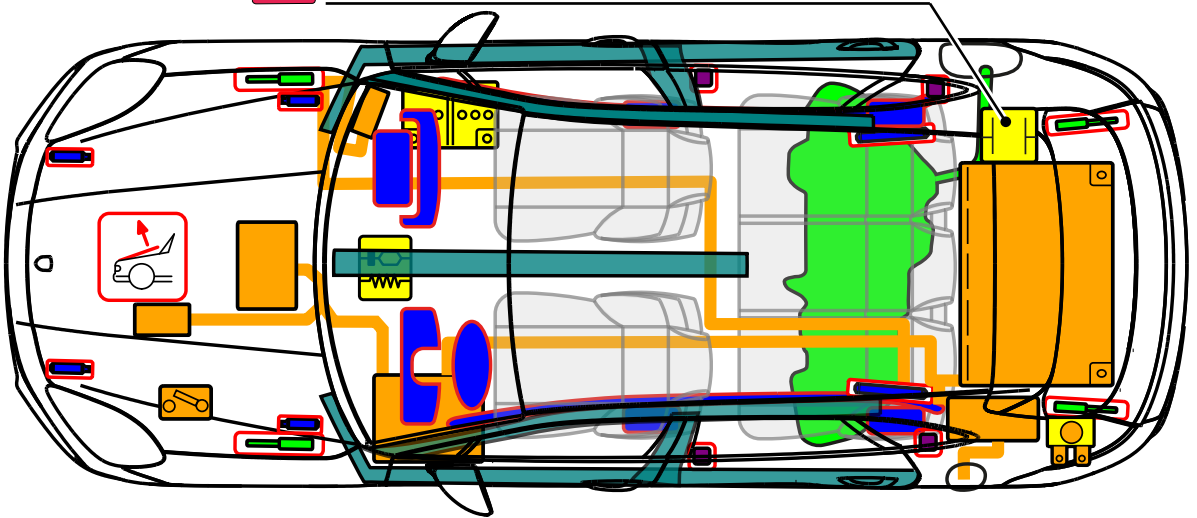







PORSCHE



 Caution 48 V (optional) Turn off the ignition!



	Airbag		Body reinforcement		SRS-Control unit		High voltage battery
	Gas generator		Gas strut		12-volt Battery		High voltage cable / component
	Seat belt pretensioner		Pedestrian protection system		Fuse box		High voltage cut-off
	Fuel tank		Roll-over protection		Condenser		

Vehicle identification and marking

Panamera Cayenne E-Hybrid identification features – standard equipment



'e-hybrid' logo on the **engine cover**

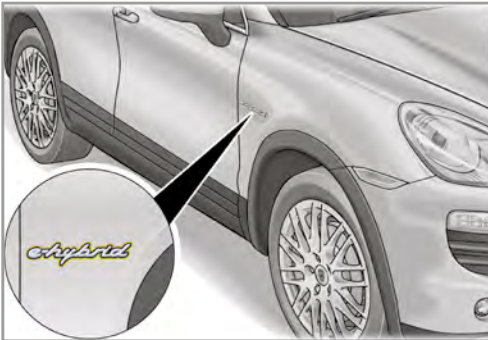

'e-hybrid' logo on the **right- and left-hand doors**

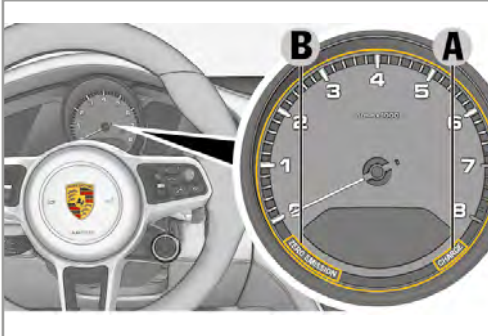

On the **instrument cluster**

B = 'E-POWER'

A = 'CHARGE'

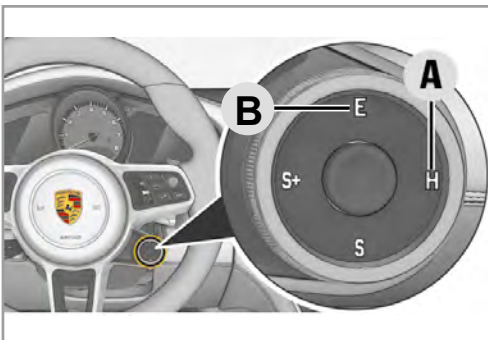

A = 'H' labelling on the knob

B = 'E' labelling on the knob



Vehicle charging connection behind the charging-socket lid on rear left side of the vehicle

Marking of the hybrid components

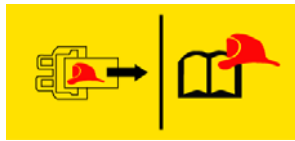
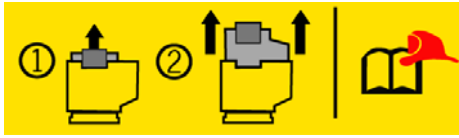

All high-voltage components and high-voltage disconnection points are clearly marked with warning/information stickers.

All high-voltage cables have orange insulation.

Safety information about the hybrid system

Undamaged plugs, connectors, cables and sockets in the on-board high-voltage system are safe to touch.

! DANGER

Risk of serious or fatal injury from electric shock if handled incorrectly!

If high-voltage components are not handled correctly, there is a risk of fatal injury.

- **Do not touch high-voltage components that are in operation.**
- Do not damage the orange high-voltage cables in the on-board high-voltage system.
- There may still be voltage in the high-voltage battery even after the on-board high-voltage system has been switched off. The high-voltage battery must not be damaged or opened.

Switching off the passive safety system and high-voltage system

⚠ WARNING The electric motor is silent when stationary!

You cannot always tell from the operating noise whether the car is ready to start because the electric motor is silent when stationary.

- The vehicle may be ready to start even when no engine noises can be heard.
- If the ignition is switched on, the combustion engine may start automatically depending on the level of charge of the high-voltage battery.

NOTE Deactivating the HV system

The high-voltage system switches off automatically in accidents where the airbags or seat belt pre-tensioners are activated.

To make sure that the **high-voltage system** is deactivated, it is recommended – depending on accessibility – to use the **primary or secondary emergency disconnection point as the deactivation method:**

1. Primary emergency disconnection point: Switch ignition to '**OFF**' and unplug the 12-volt service plug (marked with a flag) on the front left side in the engine compartment.
2. Secondary emergency disconnection point: Switch ignition to '**OFF**' and pull out fuse number **10** (marked with a flag) in the front right fuse box located on the left-hand side of the boot.

Other deactivation methods as described in the manual may only be performed by appropriately qualified personnel.

NOTE Deactivating the passive safety systems

To make sure that the **passive safety systems** (airbags and seat belt pre-tensioners) are deactivated,

1. the 12-volt battery in the luggage compartment should be disconnected. The waiting time after disconnection of the 12-volt battery is 1 minute.
2. the high-voltage system should be deactivated via the primary or secondary emergency disconnection point to ensure there is no voltage in the on-board 12-volt battery.

Deactivating the high-voltage system

Switching off the ignition

The method of switching off the high-voltage system described below applies to both vehicles with a conventional key and those with Porsche Entry & Drive (keyless entry system). In both cases, the ignition must be turned to 'OFF' first.

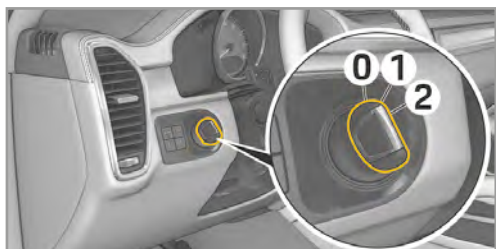

1. Turn the ignition to 'OFF' (0 position).

Primary emergency disconnection point: unplugging the 12-volt service plug in the engine compartment at the front left

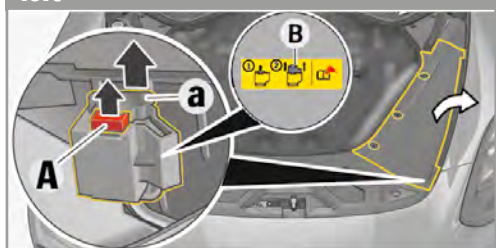

1. Remove the cover.
2. Unplug the 12-volt service plug.
3. Unlock -A- and unplug -a- the service plug (marked with a flag -B-).

- There is no voltage in the high-voltage system approx. 20 seconds after it has been switched off.
- The passive safety systems, such as airbags and seat belt pre-tensioners, are still supplied with voltage from the on-board 12-volt battery.

Secondary emergency disconnection point: Pulling the fuse in the fuse box of the left side of the trunk

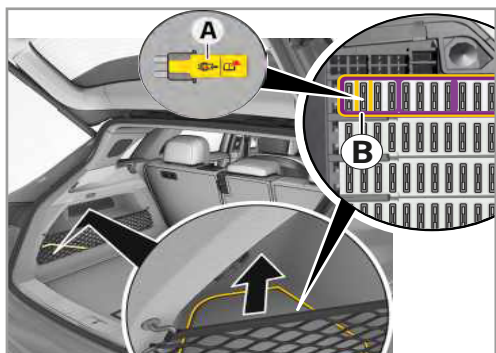

1. Open the breaker box cover in the left side of the trunk.
2. Remove the retaining frame (B) from the fuse block.
3. Unplug fuse number 10 (marked with a flag A).

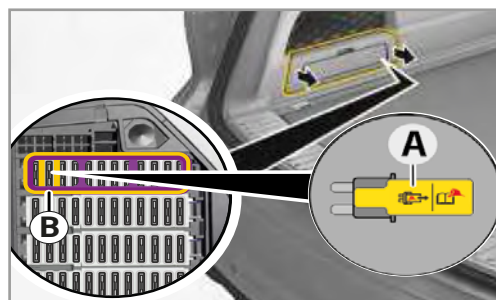

1. With an optional DVD changer: remove the case from the left side of the trunk.
2. Remove the retaining frame (B) from the fuse block.
3. Unplug fuse number 10 (marked with a flag A).

- There is no voltage in the high-voltage system approx. 20 seconds after it has been switched off.
- The passive safety systems, such as airbags and seat belt pre-tensioners, are still supplied with voltage from the on-board 12-volt battery.

Deactivating the passive safety systems

Disconnecting the 12-volt battery

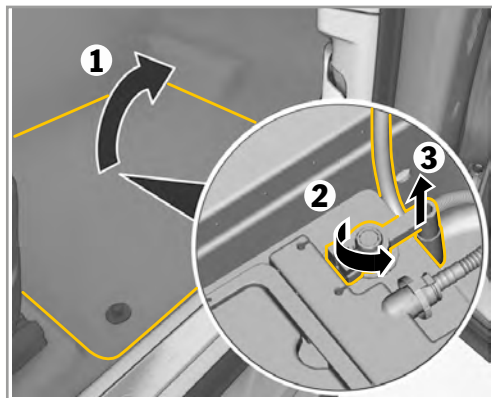

Ensure that no jump leads are connected to the vehicle.

1. Move the passenger seat back to the furthest position, if possible.
2. Loosen the carpet cut-out (-1-) in the front left footwell.
3. Disconnect the negative cable of the 12-volt battery (-2-) and secure it to prevent accidental contact (-3-).

- Additionally deactivate the high-voltage system at an emergency separation point.
- The passive safety systems (airbags and seat belt pre-tensioners) are deactivated. The waiting time after disconnection of the 12-volt battery is 1 minute.

Other accident situations

Vehicle in water

There is no risk that the car body will be live. Once the vehicle has been recovered:

1. Allow the water to run out of the interior.
2. Begin switching off the high-voltage system.

Vehicle/battery fire

Suitable extinguishing agent:

water (H₂O), larger quantities to cool the lithium ion battery

⚠ WARNING Battery cells explode when hot!

Battery modules might explode if the high-voltage battery becomes too hot.

- Keep to the required safety distances when fighting the fire.



**Porsche AG, 911 (992) all derivatives,
Coupé
from Model Year 2019**

PORSCHE

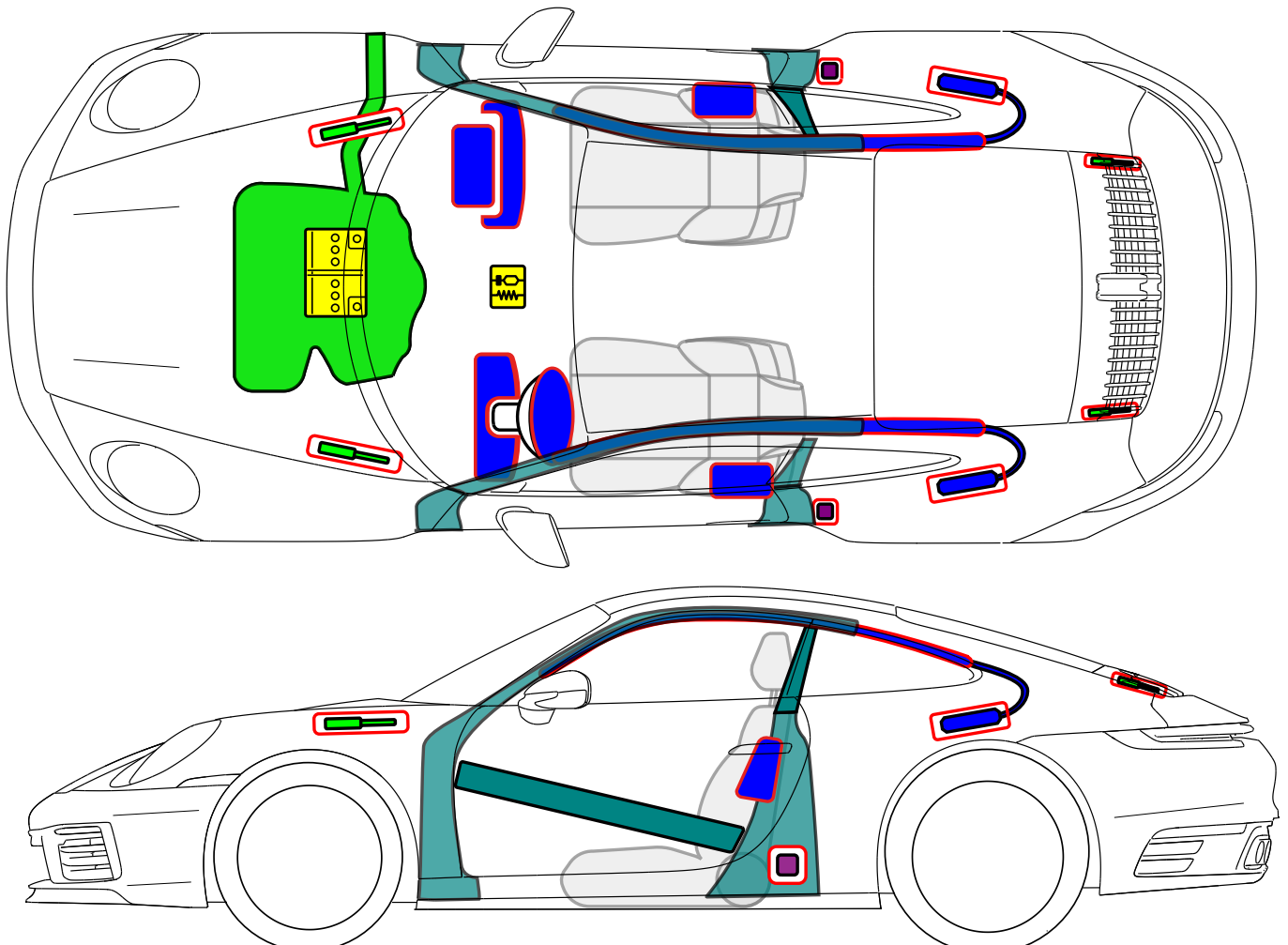

	Airbag		Body reinforcement		SRS-Control unit		High voltage battery
	Gas generator		Gas strut		12-volt Battery		High voltage cable / component
	Seat belt pretensioner		Pedestrian protection system		Fuse box		High voltage cut-off
	Fuel tank		Roll-over protection		Condenser		



PORSCHE

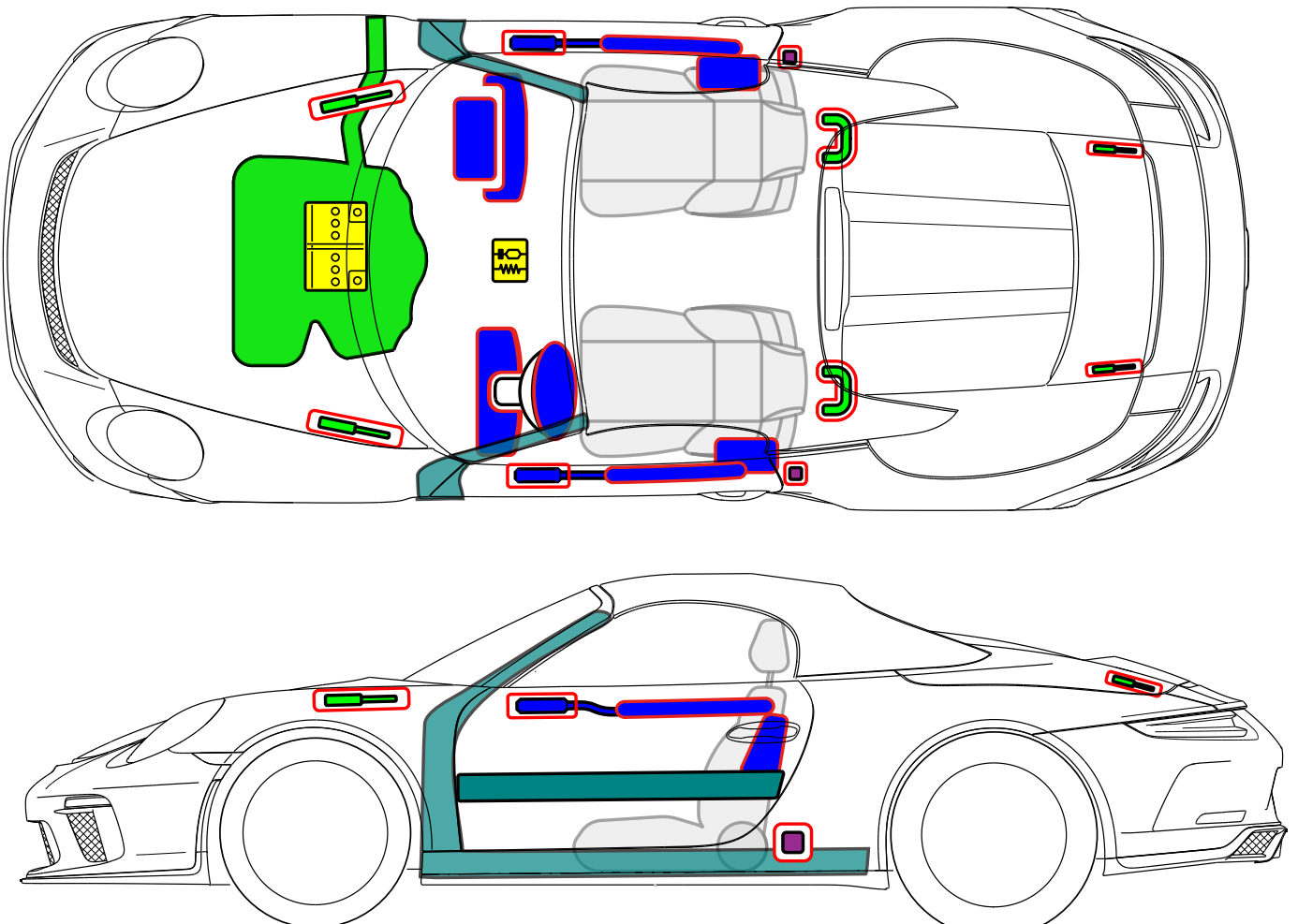

	Airbag		Body reinforcement		SRS-Control unit		High voltage battery
	Gas generator		Gas strut		12-volt Battery		High voltage cable / component
	Seat belt pretensioner		Pedestrian protection system		Fuse box		High voltage cut-off
	Fuel tank		Roll-over protection		Condenser		



PORSCHE

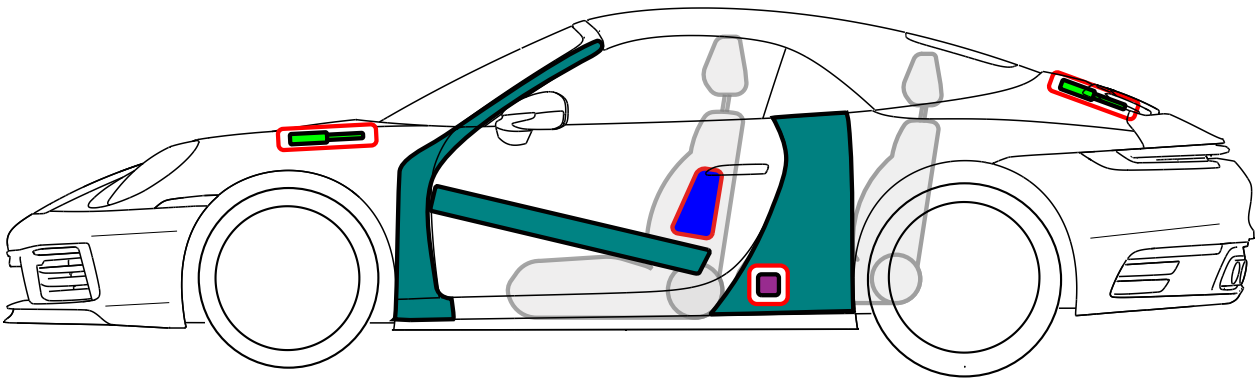
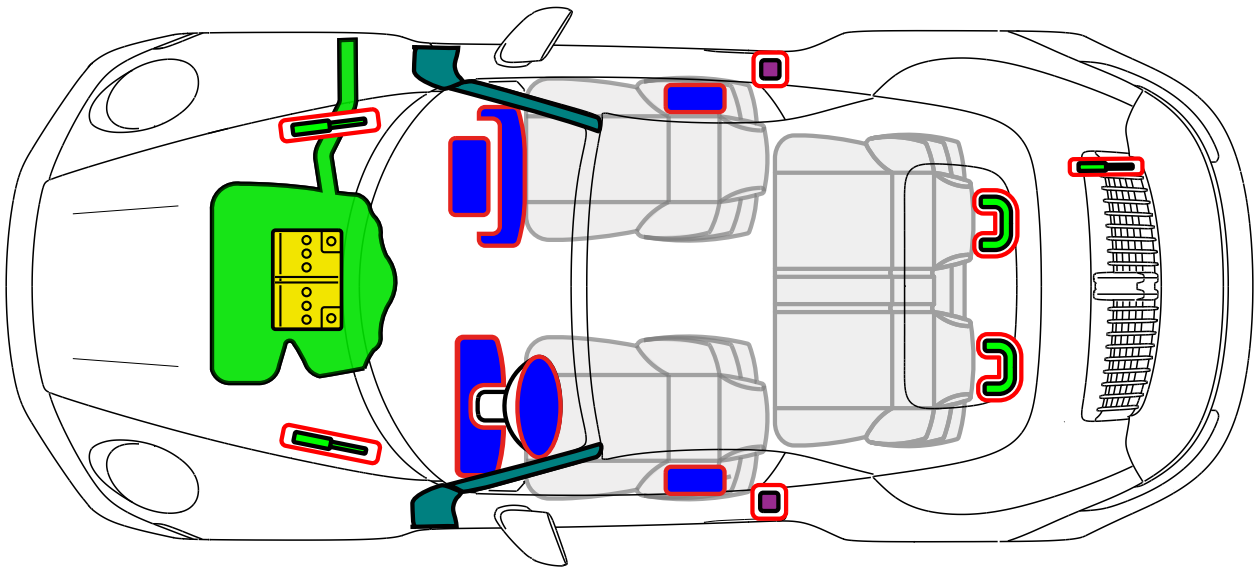

	Airbag		Body reinforcement		SRS-Control unit		High voltage battery
	Gas generator		Gas strut		12-volt Battery		High voltage cable / component
	Seat belt pretensioner		Pedestrian protection system		Fuse box		High voltage cut-off
	Fuel tank		Roll-over protection		Condenser		



**Porsche AG, 718 Cayman GT4 (982)
all derivatives, Coupé
from Model Year 2019**

PORSCHE

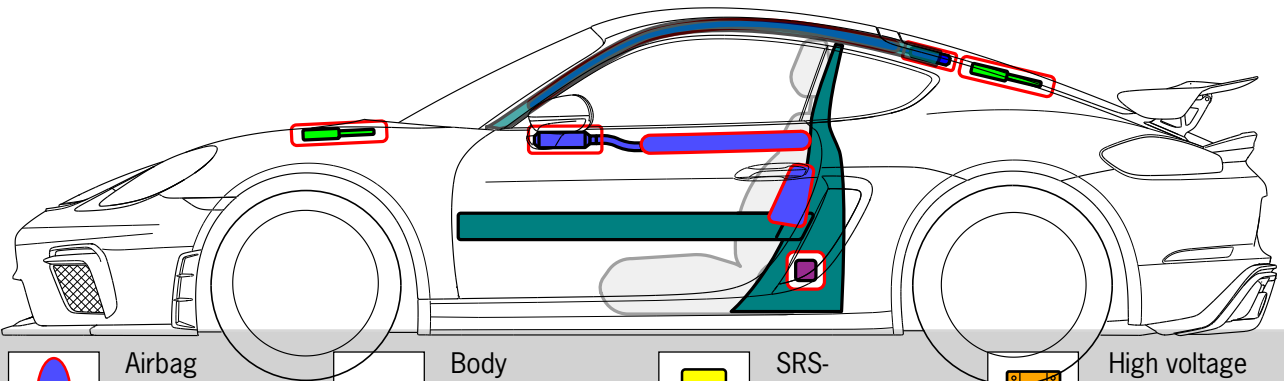
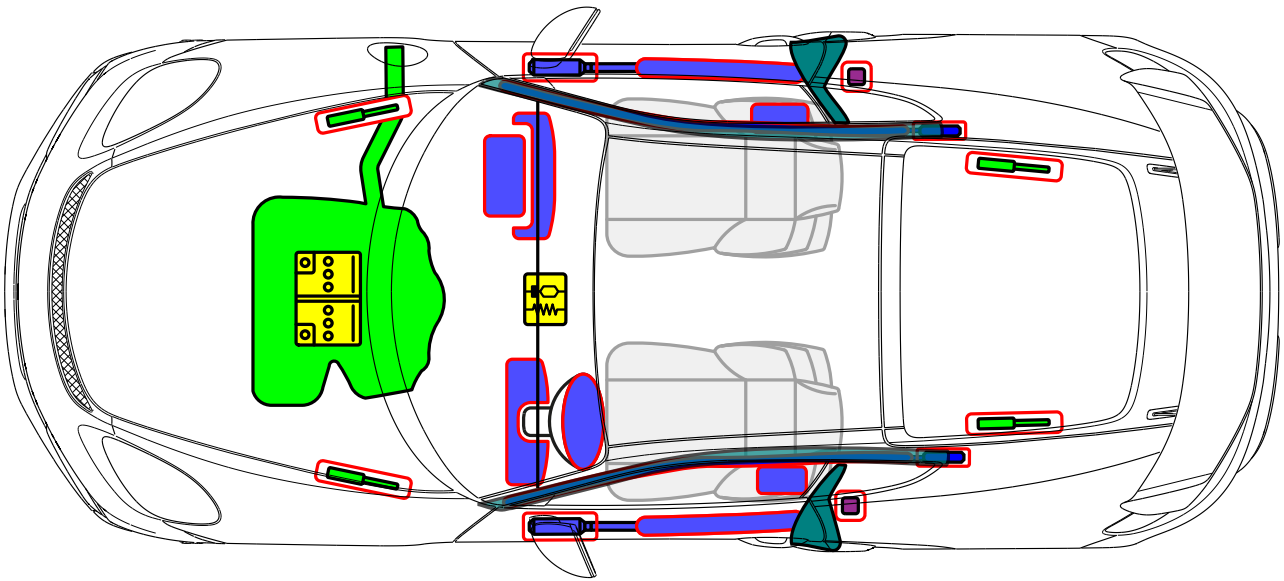

Airbag



Body reinforcement



SRS-Control unit



High voltage battery



Gas generator



Gas strut



12-volt Battery



High voltage cable / component



Seat belt pretensioner



Pedestrian protection system



Fuse box



High voltage cut-off



Fuel tank



Roll-over protection



Condenser



**Porsche AG, Boxter Spyder (982)
all derivatives, Cabriolet
from Model Year 2019**

PORSCHE

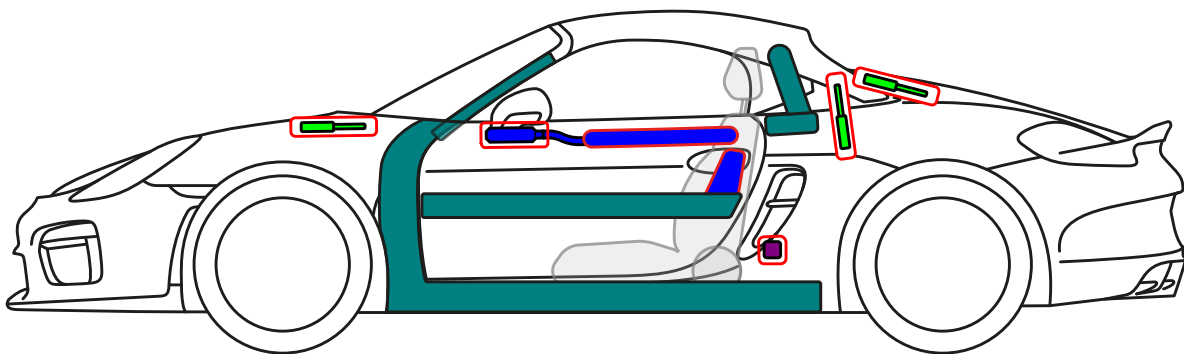
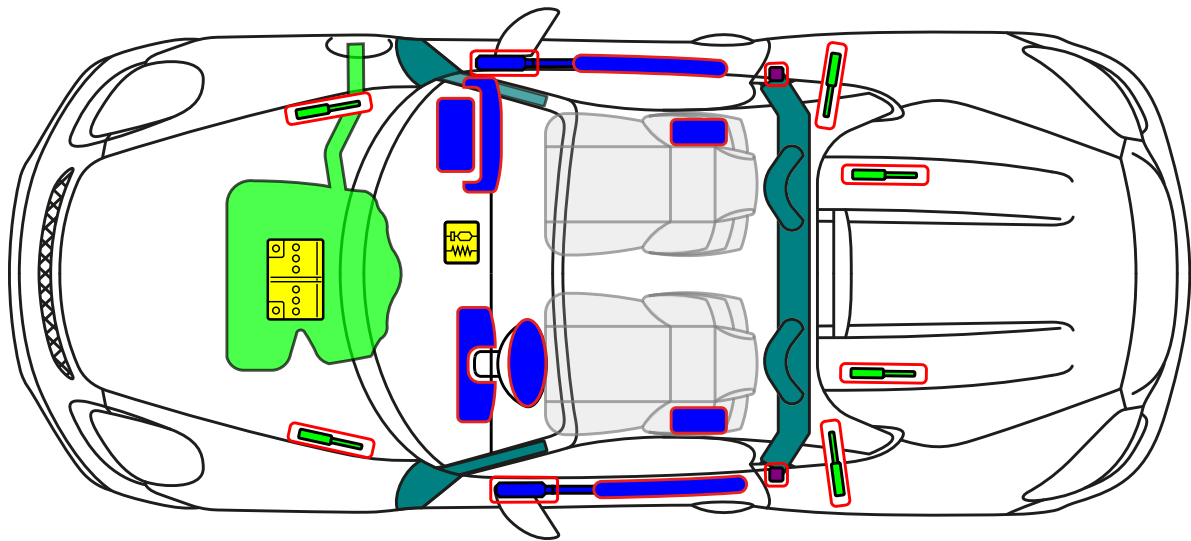

	Airbag		Body reinforcement		SRS-Control unit		High voltage battery
	Gas generator		Gas strut		12-volt Battery		High voltage cable / component
	Seat belt pretensioner		Pedestrian protection system		Fuse box		High voltage cut-off
	Fuel tank		Roll-over protection		Condenser		



**Porsche AG, Taycan, all derivatives (Y1A),
Saloon
from MY 2020**



PORSCHE



Secondary emergency disconnection point

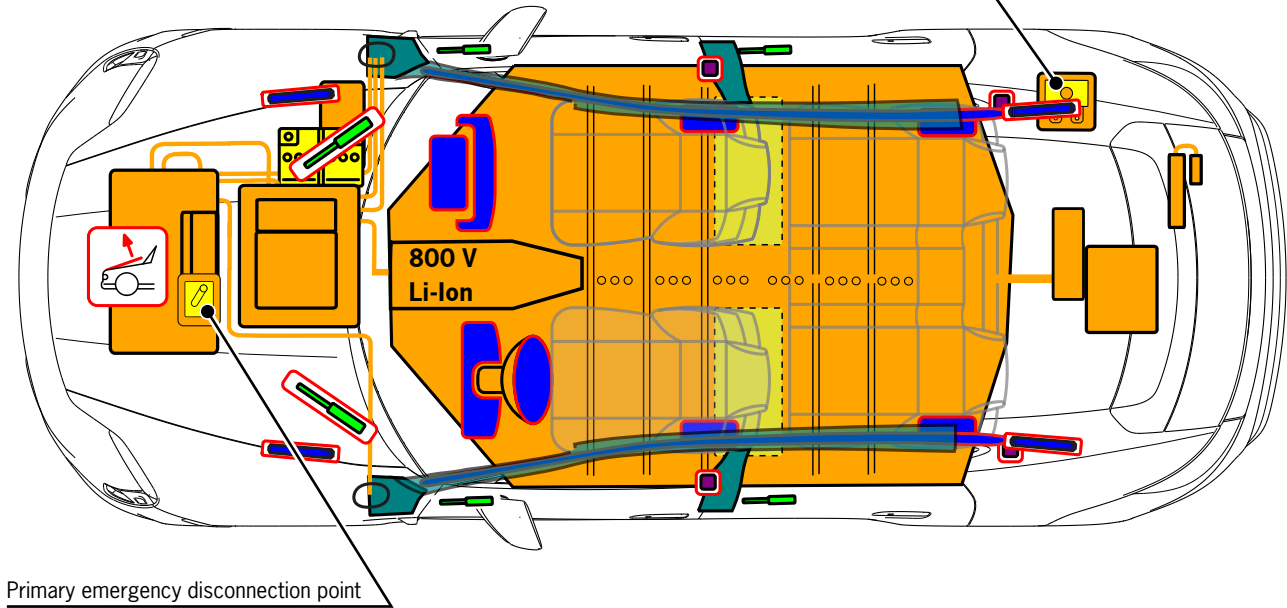

Primary emergency disconnection point

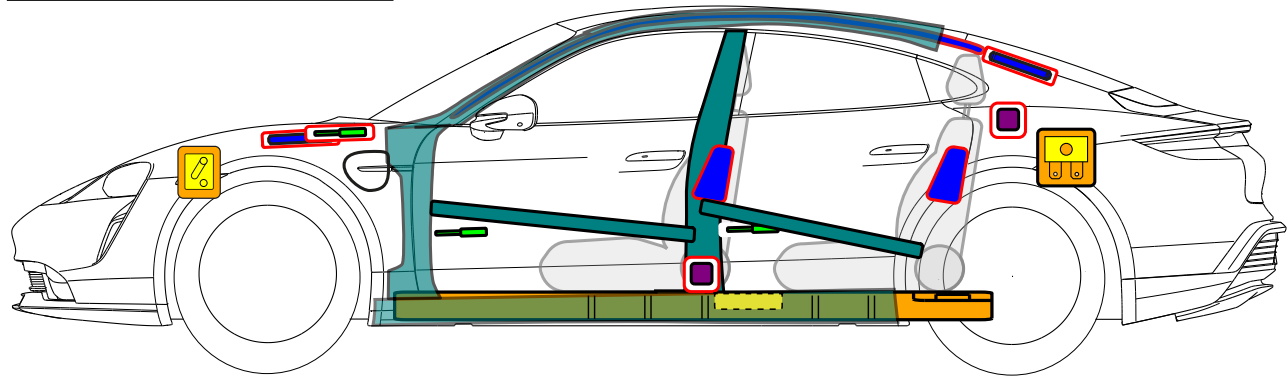

	Airbag		Body reinforcement		SRS-Control unit		High voltage battery
	Gas generator		Gas strut		12-volt Battery		High voltage cable / component
	Seat belt pretensioner		Pedestrian protection system		Fuse box		High voltage cut-off
	Fuel tank		Roll-over protection		Condenser		

1. Vehicle identification and marking

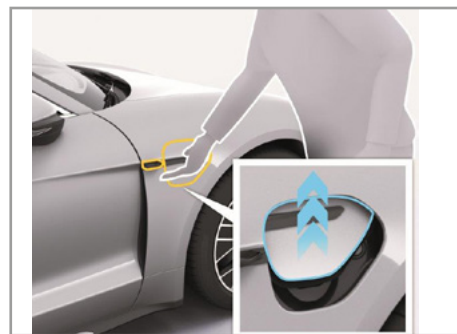

The Porsche Taycan is only available with an electric powertrain.

Taycan

The Porsche Taycan can be identified by the design of its body, the (optional) logo on the rear, and the electrical symbols in the instrument cluster.

2. Shutdown / stabilization / lifting

Press switch **P**.

This automatically activates the parking brake.



3. Avoidance of direct hazards / safety precautions

Switching off the ignition

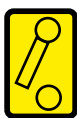

Press START-STOP without pressing the foot brake.

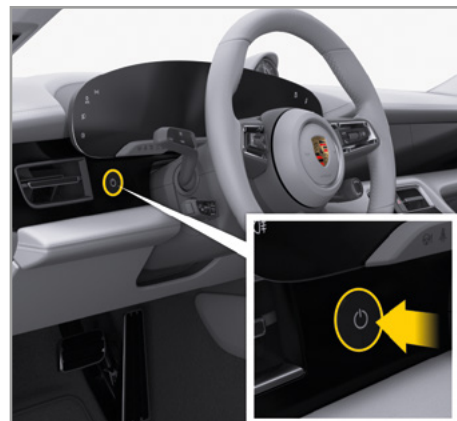

The absence of engine noise does not mean that the vehicle is switched off.



Re-starting is possible until the vehicle has been shut down.

Deactivating the high-voltage system



The high-voltage system is automatically deactivated in the case of accidents where airbags and seat belt pretensioners have been triggered.



In all other cases, the high-voltage system must be deactivated as follows:

Deactivating the high-voltage system

Option 1 - Primary emergency disconnection point:

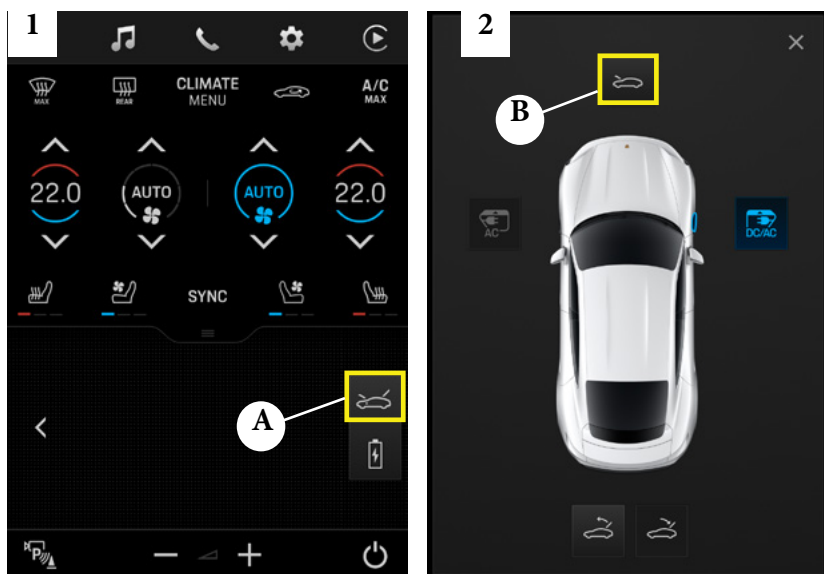

Open the front flap via the operating menu

1. Tap button **-A-**.
2. Tap button **-B-**.

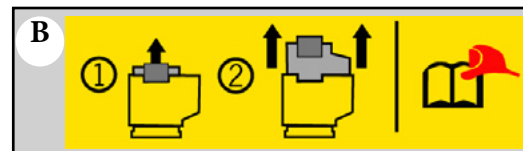

Primary emergency disconnection point:

1. Remove the cover at the rear of the luggage compartment.
2. Release **-A-**.
3. and detach the service connector (marked with tab **B**) **-a-**.

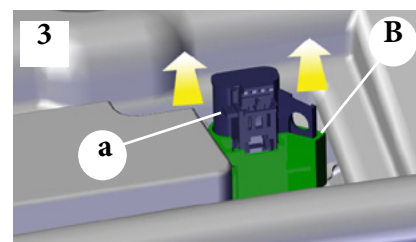
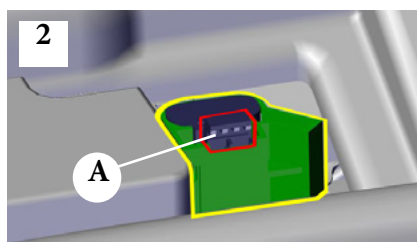
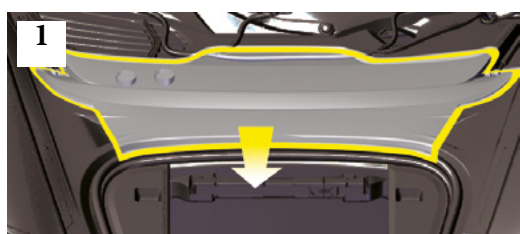

Option 2 - Secondary emergency disconnection point:

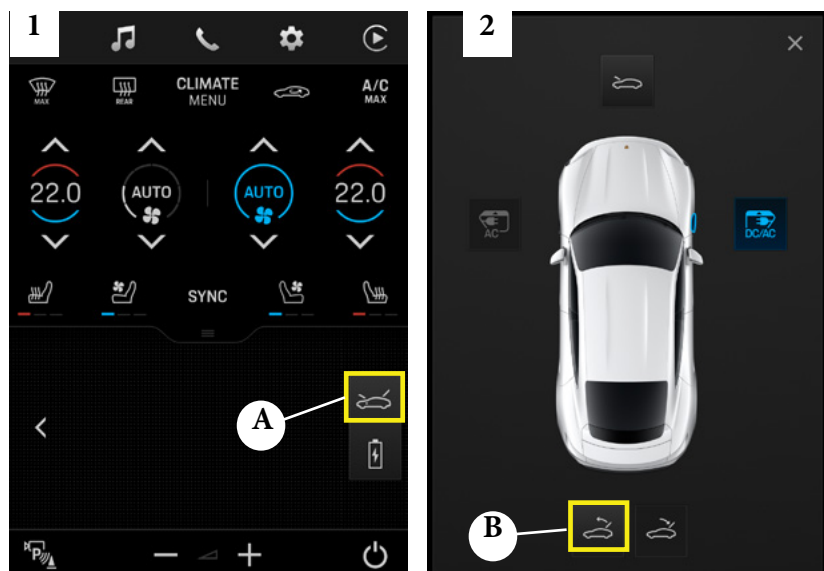

Open the tailgate via the operating menu

1. Tap button **-A-**.
2. Tap button **-B-**.



Option 2 - Secondary emergency disconnection point:

1. Remove the side cover on the right-hand side of the luggage compartment.
2. Remove the retaining frame (-K-) from the fuse block.
3. Detach fuse no. 1 (marked with tab A).

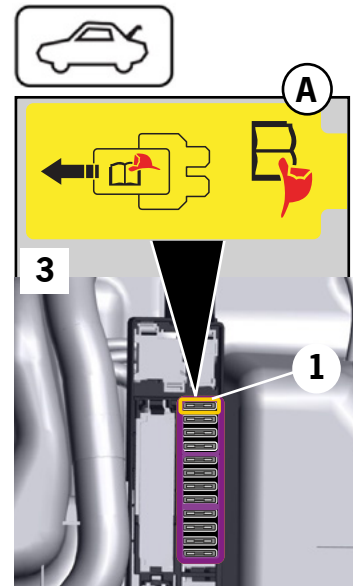
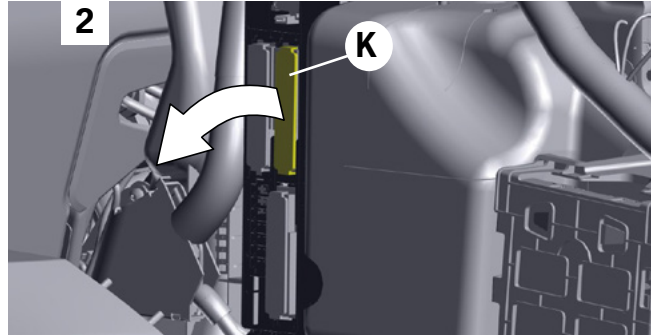

Wait around 20 seconds after switching off in order to ensure that no residual voltage is left in the high-voltage system.



The passive safety systems such as airbags and seat belt pretensioners continue to be provided with power by the 12-volt on-board power supply.

Disconnecting the 12 V battery

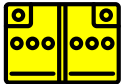

1. Remove the cover from the 12-volt battery at the rear right of the luggage compartment.
2. Unfasten the negative cable of the 12-volt battery at the screw connection and secure against accidental contact.



The passive safety systems (airbags and seat belt pretensioners) are deactivated.

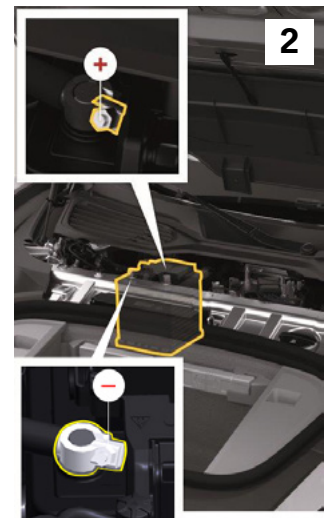

4. Accessing vehicle occupants

When freeing occupants, attention must be paid to the parts of the bodywork made of high-strength steel and the components of the restraint systems (in particular pyrotechnic devices) as specified on Page 1.



It is essential to avoid additional deformation of the sill panels and the underbody during the rescue operation (e.g. use of hydraulic equipment to provide support).

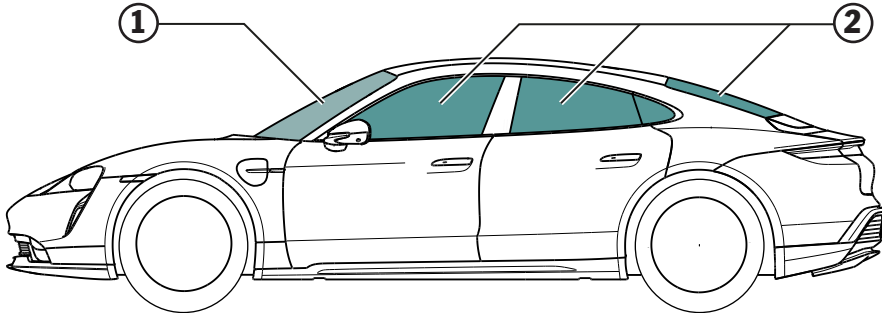

Types of glass

- ① Laminated safety glass
- ② Tempered safety glass

5. Stored energy / liquids / gases / solids

LI ION



All high-voltage cables are provided with orange-colored insulation.



NEVER cut, break, or touch high-voltage components or cables. This could result in serious injuries or death.

6. Vehicle fires

Use large quantities of water (H₂O) to extinguish a vehicle fire.

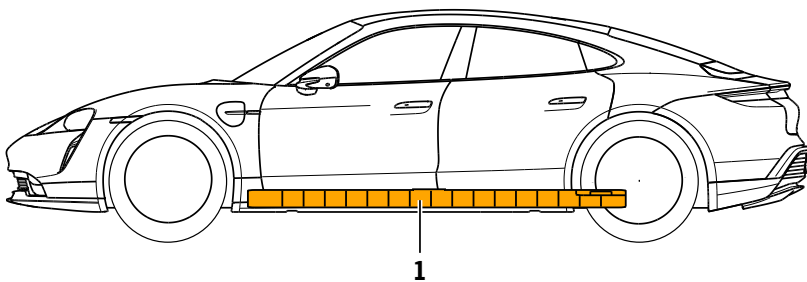

1 High-voltage battery

Use an ample quantity of water (H₂O) to cool the li-ion battery.



Warning: Re-ignition of the battery



In the event of damage or improper use, lithium-ion batteries can ignite spontaneously or with a delay, or ignite again after the fire has been extinguished.

1. Check battery temperature with a thermal infrared camera or thermometer.
Non-critical temperature range: <65 °C.
2. Wear appropriate personal protective equipment.



7. Vehicle in water

There is no risk of voltage being applied to the bodywork.

After recovering the vehicle:

1. Allow the water to drain out of the inside of the vehicle.
2. Initiate deactivation of the high-voltage system (see Section 3).

8. Towing / transportation / storage

Only transport the vehicle with both axles on a tow truck or car transporter.

Check the temperature of the lithium-ion battery before transport.

Non-critical temperature range: <65 °C.



Keep it at a safe distance from other vehicles.



Warning: Re-ignition of the battery



9. Important additional information

Further information on accident assistance and the recovery of vehicles with high-voltage systems can be found at <https://www.vda.de/en/services/Publications/rescue-and-towing-of-vehicles-with-high-voltage-systems.html>

9. Explanation of pictograms used

	Electric vehicle		Flammable
	Warning / Caution		Hazardous to the human health
	Warning, Electricity		Corrosives
	Electronic vehicle key distance		Acute toxicity
	Open the hood		Use thermal infrared camera
	Open the tailgate		Use water to extinguish the fire
	High-voltage battery (Lithium-Ion)		