

Emergency Response Guide



SORENTO PHEV

ECO plug-in



Contents

1. Identification / Recognition	3
2. Immobilization / Stabilization / Lifting	8
3. Disable Direct Hazards / Safety Regulations	9
4. Access to the Occupants	14
5. Stored Energy / Liquid / Gases / Solids	17
6. In Case of Fire	21
7. In Case of Submersion	25
8. Towing / Transportation / Storage	26
9. Important Additional Information	29

1. Identification / Recognition

Initial Response: Identify, Immobilize and Disable

The following procedures should be used whenever you are dealing with a Sorento PHEV at an emergency scene. However, all operations should be consistent with your department's standard operating procedures, guidelines, and any applicable laws. When an PHEV is damaged in a crash, the high voltage safety systems may have been compromised and present a potential high voltage electrical shock hazard. Exercise caution and wear appropriate personal protective equipment (PPE) safety gear, including high voltage safety gloves and boots. Remove all metallic jewelry, including watches and rings.

Identify

The Sorento PHEV is a hybrid electric vehicle. Emergency responders should respond to emergency scenarios involving the Sorento PHEV accordingly, exercising extreme care and caution to avoid contact with the high voltage system within the vehicle.



1. Identification / Recognition

1.1 Identifying a Kia SORENTO PHEV

Orange Color Cables

Orange color cables run under the floor of the vehicle and under the hood. When opening the hood, the orange color cable identifies a PHEV.



Charging Port

- The charging port is located on the side of the vehicle.

#Note : The doors must be un-locked to open the charge port door.

How to open the charging port

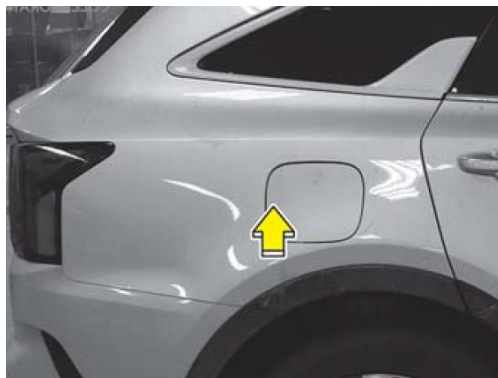

1. Press the unlock door button, depress the brake pedal and apply the Electric Parking Brake (EPB).
2. Turn OFF all switches, move the shift dial to P (Park) and turn off the vehicle.
3. Open the charging inlet door by pressing rear center edge of the charging inlet door.

Unlock charging door in an emergency

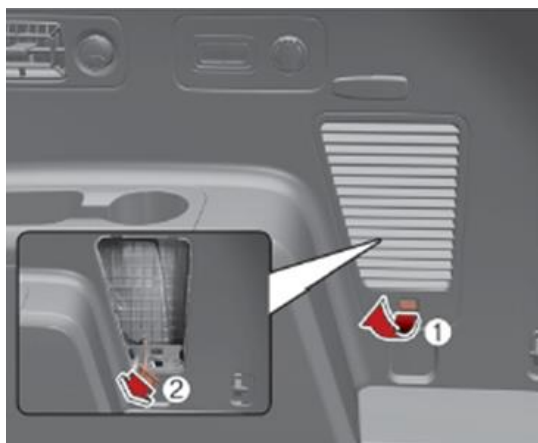

- Charging door can be open even if the battery is discharged. (Push the charging port)
- The charging cable may not be disconnected when foreign materials enters the cable or the cable is encrusted with ice.
- If this happens, open the cover(1) on the right side of the luggage room and pull the emergency cable(2) lightly 2 to 3 times.

1. Identification / Recognition

1.1 Identifying a Kia SORENTO PHEV

VIN Label

The VIN (Vehicle Identification Number) identifies the Plug-in hybrid with a "H" displayed in the 8th position, as shown in the below drawing.

The VIN can be found:

- 1) Underneath the front passenger seat (or driver seat).
- 2) On the vehicle certification label attached to the driver's side center pillar.
- 3) VIN Plate also can be seen through the windshield from outside.

XXXXXXXXHXXXXXXXXX

← 8th position

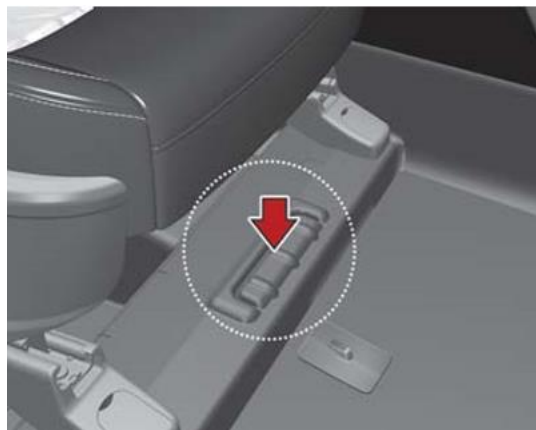

1. Identification / Recognition

1.1 Identifying a Kia SORENTO PHEV

SORENTO PHEV Cluster Instrument Panel

The Sorento Plug-in Hybrid cluster instrument panel displays the PHEV specific features such as high voltage battery SOC (State of Charge) in the highlighted part.

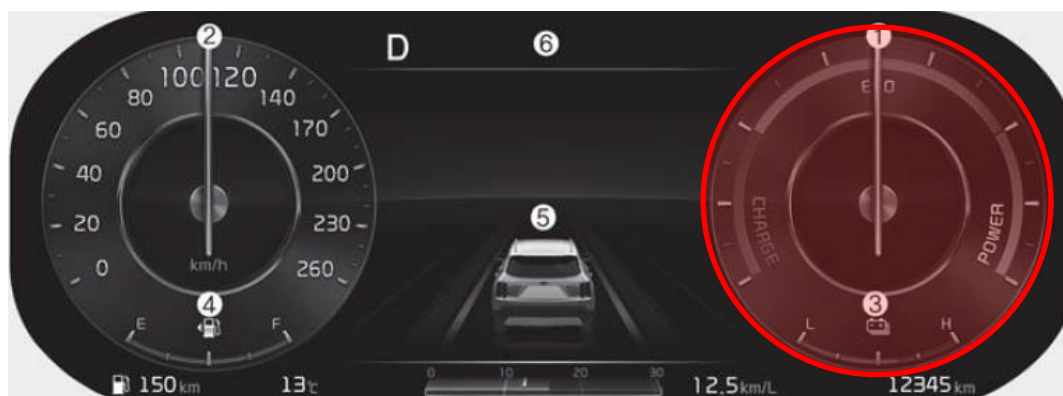
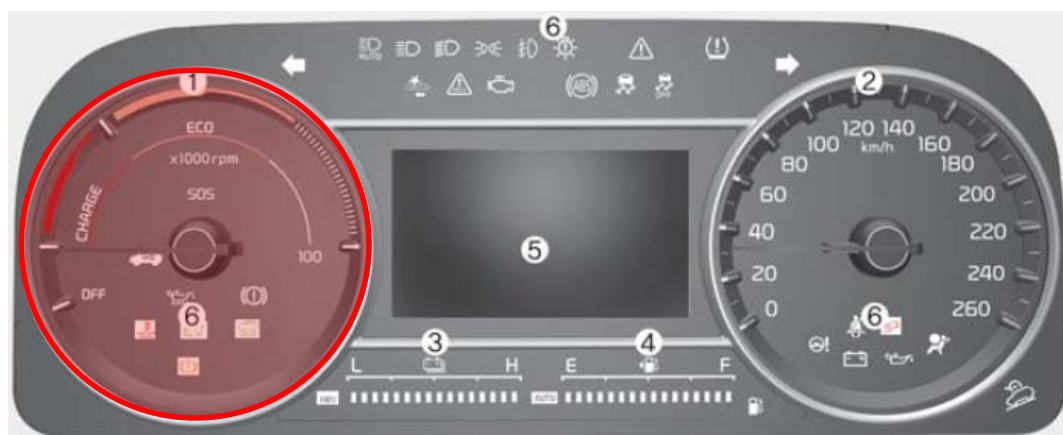

- | | |
|-----------------------------|--------------------------------|
| 1. Power gauge | 4. Fuel gauge |
| 2. Speedometer | 5. LCD display |
| 3. Hybrid battery SOC gauge | 6. Warning and indicator light |

1. Identification / Recognition

1.1 Identifying a Kia SORENTO PHEV

Charge Status Indicator

When charging or using the high voltage battery, can check the charging status of the battery by looking at the color of the lights or lights within the charging port of the vehicle. The color of illuminated lights indicates the charge level of the battery.



Classification		Details	Lamp indication	
Mode	Status		Charging inlet	Charge button
A	READY	Non-charging state (Battery state 0 ~ 65 %)	ON (Yellow)	OFF
		Non-charging state (Battery state 65 ~ 100 %)	ON (Green)	OFF
B	Aux. Battery Saver/High voltage warning	Aux. Battery Saver/High voltage warning state	ON (Red)	OFF
C	Charging	Charging (charging connector connected) (Battery state 0 ~ 65 %)	Blink (Yellow)	OFF
		Charging (charging connector connected) (Battery state 65 ~ 100 %)	Blink (Green)	OFF
D	Charging complete	Charging complete/Shutdown status (OFF after approx. 5 seconds)	ON (Green) → OFF	OFF
E	Charging failed	Charging failed (charging connector connected)	Blink (Red)	OFF
F	Scheduled charging standby	Scheduled charging standby (charging connector connected) (OFF after approx. 3 minutes)	OFF	ON
G	Error	CAN communication error status	ON (Green) → ON (Orange) → ON (Red)	OFF

2. Immobilization / Stabilization / Lifting

2.1 Immobilization

The next step is to immobilize the vehicle to prevent any accidental movement that can endanger response personnel or civilians. When the Sorento PHEV is damaged in a crash, the vehicle may appear to be shut off, even when it actually is not, due to a lack of engine sounds. When the "READY" mode light is illuminated on the Instrument Panel, the vehicle can move silently using the electric motor. Responders should approach the vehicle from the sides and stay away from the front or rear as they are potential paths for vehicle movement. Be sure to immobilize the vehicle in the following manner.

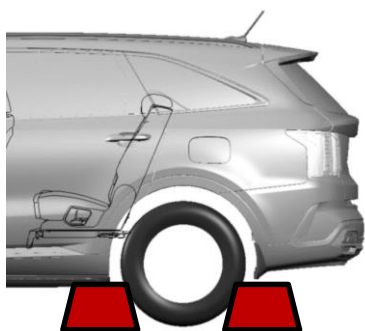

Chock the wheels



Set the Electronic Parking Brake (EPB)



Put the vehicle in P (Park) position by pressing the 'P' button on the rotary shifter

2.2 Vehicle Stabilization

Use standard stabilization (lift) points, as shown on the right. Always be sure to connect to a structural components of the vehicle and avoid placing cribbing under high voltage cables, and other areas not normally considered acceptable.

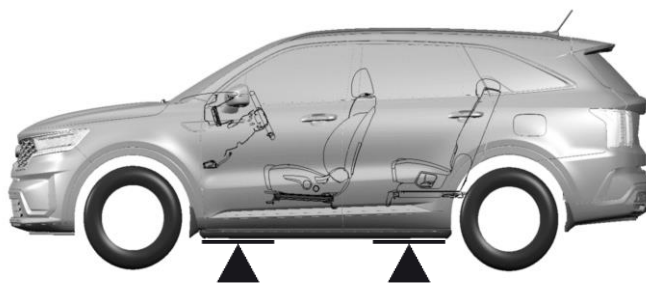

CAUTION

- When installing a block or jack, avoid high voltage cable, battery and fuel system (exhaust system).
- If high voltage components or cables are exposed, do not place any support on them.

3. Disable Direct Hazards / Safety Regulations

The final step in the initial response process, conducted after immobilizing the vehicle, is to disable the vehicle, its SRS components and the high voltage electrical system. To prevent current flow through the system, use one of the following procedures to disable the vehicle.

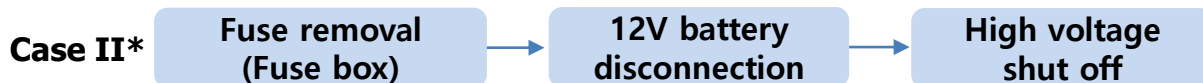
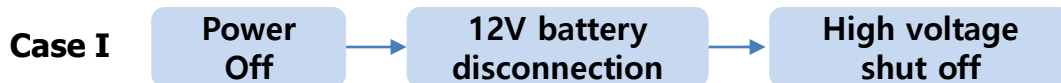

*In case of emergency

3.1 Disabling the System – Smart Key System and “POWER”

START/STOP Button

1. Confirm the status of the READY light on the instrument panel. If the  READY light is illuminated, the vehicle is ON.

a) If the READY light is NOT illuminated, the vehicle is off. Do not push the “POWER” START/STOP button because the vehicle may start (go into READY mode).

b) To turn OFF the system, press the 'P' (Park) button on the rotary shifter dial, and press the POWER button.

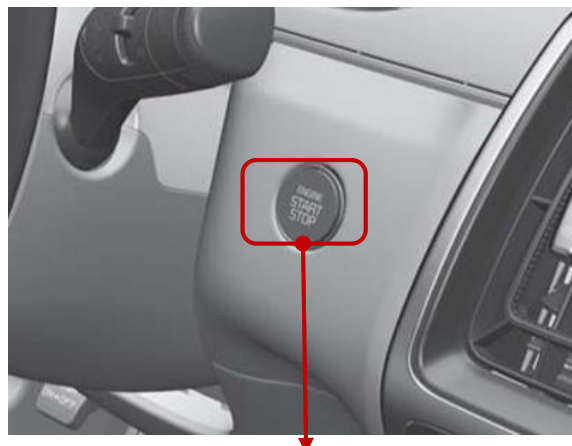

“POWER” START/STOP Button

3. Disable Direct Hazards / Safety Regulations

Without depressing the brake pedal

Pressing POWER button	Vehicle condition
One time	Electrical accessories are operational.
Two times	The warning lights can be checked before the vehicle is started.
Three times	Off

While depressing the brake pedal

Pressing POWER button	Vehicle condition
One time	Ready to drive

2. If necessary, lower the windows, unlock the doors and open the tail gate as required, before disconnecting the 12V battery. Once the 12V battery is disconnected, power controls will not operate. (Refer to below “4. – c” for 12V battery disconnection)

3. Before disconnecting the 12V battery, remove the smart key at least 2 meters away from the vehicle to prevent accidental restart.

3. Disable Direct Hazards / Safety Regulations

4. Follow the procedure below to remove the safety plug and disable the high voltage battery:

a) Open the luggage mat (A).



b) Remove the auxiliary battery service cover (A).



c) Disconnect the auxiliary 12V negative (-) battery terminal (A) after loosening the nut.



d) Disconnect the service interlock connector (A).



If the service interlock connector can not be disconnected, cut the service interlock connector wire.



3. Disable Direct Hazards / Safety Regulations

3.2 Disabling the System – IG (Ignition) Fuse Removal

1. Open the hood.
2. Remove the engine room fuse box cover.
3. If necessary, lower the windows, unlock the doors and open the tailgate as required, before disconnecting the 12V battery (located in the left side of the engine room). Once the 12V battery is disconnected, power controls will not operate.



Engine room fuse box

4. In the event the vehicle is unable to be disabled using the “Power” START/STOP Button, using the fuse puller located in the engine room fuse box, pull both the IG1, IG2 fuse from the engine room fuse box. If the IG fuses cannot be located, pull out all of the fuses and relays in the fuse box.

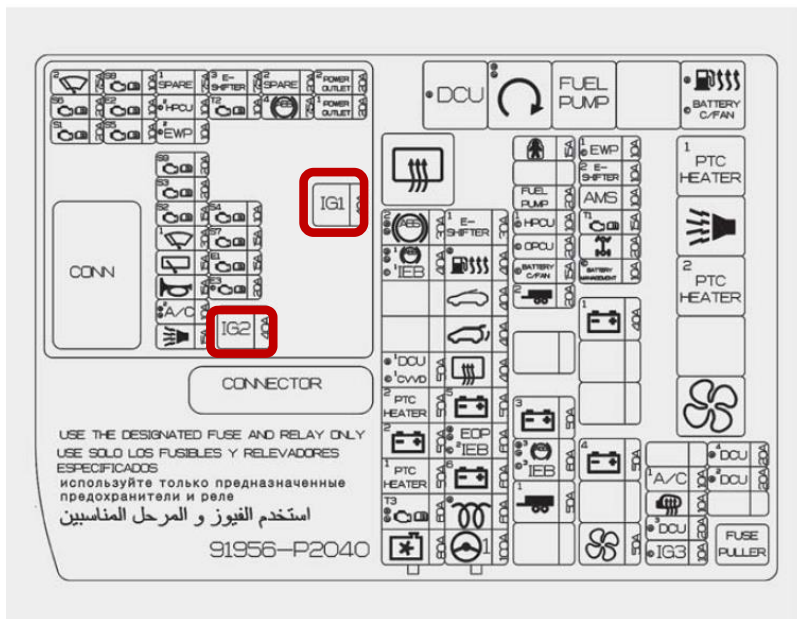

3. Disable Direct Hazards / Safety Regulations

5. Disconnect the 12V battery and interlock cable by referring to page 11.

If previously mentioned methods of disabling the vehicle's system are unsuccessful, any emergency procedures involving the PHEV vehicle may cause the accidental deployment of undeployed airbags and electric shock from high-voltage components.

CAUTION **Electrocution Risk**

- *Before engaging in any emergency response procedures, ensure the vehicle is disabled and wait 5 minutes to allow the capacitor in the high voltage system to discharge to avoid electrocution.*
- *Exposed cables or wires may be visible inside or outside the vehicle. Never touch the metal chassis wires, cables, connectors, or any electric components before disabling the system.*

Failure to follow these instructions will lead to serious bodily injury or death by electrocution.

4. Access to the Occupants

4.1 Extraction Operations

The Sorento PHEV is an eco friendly vehicle. Because of the high voltage components contained therein, first responders should pay special attention when they extract occupants in the car. Before performing any extraction operations, the first responders should "Identify, Immobilize and Disable" the vehicle as discussed in sections on emergency procedures.

4.2 Vehicle Stabilization

Use standard stabilization (lift) points, as shown beside. Always be sure to connect to a structural component of the vehicle and avoid placing cribbing under high voltage cables, and other areas not normally considered acceptable.

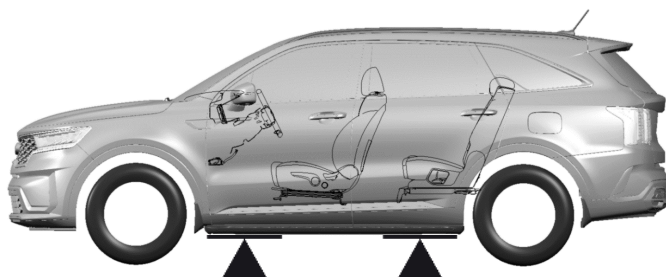

4.3 Extraction Tools and Procedure

When responding to an incident involving a Sorento PHEV, we recommend that the first responders follow their organization's standard operating procedures for dealing with vehicle emergencies.

When the first responders cut the vehicle, they should always pay special attention to the airbag system, orange colored high voltage cables and other high voltage components so that the parts are not damaged and to prevent a risk of explosion or electrocution.

4. Access to the Occupants

4.4 Location of Ultra-high Strength Steel

In these images, high strength steel is used in the areas colored in blue and ultra-high strength steel is used in the red colored areas. Depending on the tools used, ultra-high strength steel can be challenging or impossible to cut. If necessary, use a workaround technique.

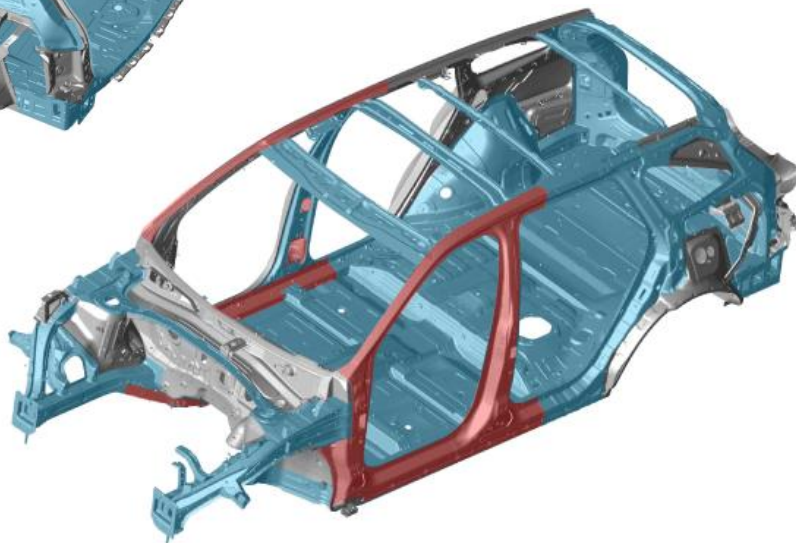
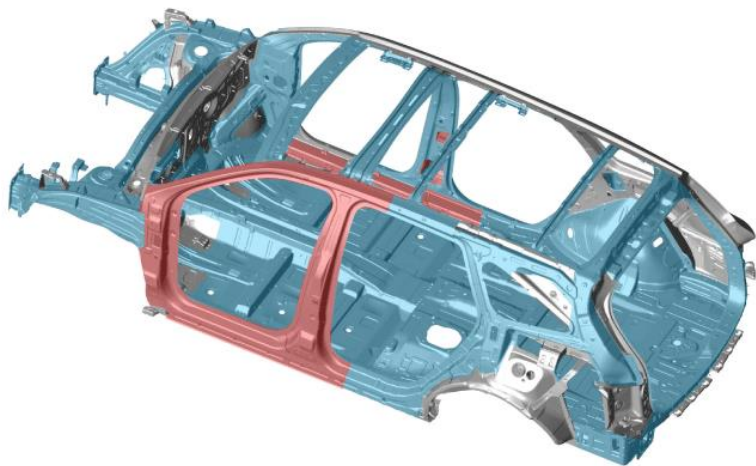
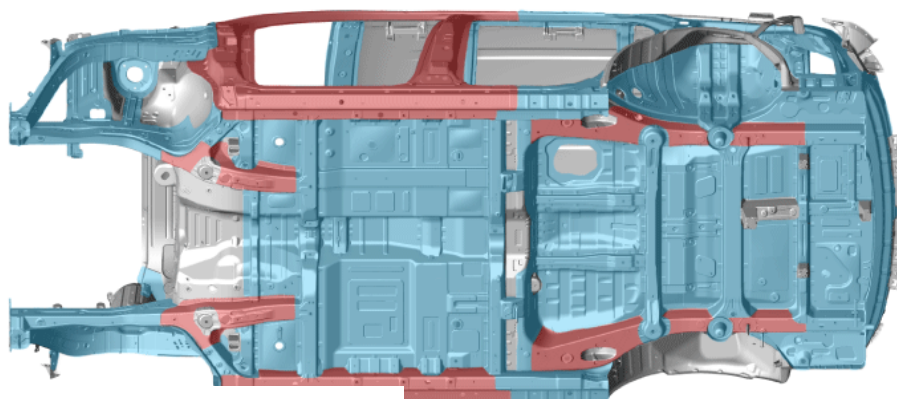

- Mild steel
- High strength steel
- Ultra-high strength steel









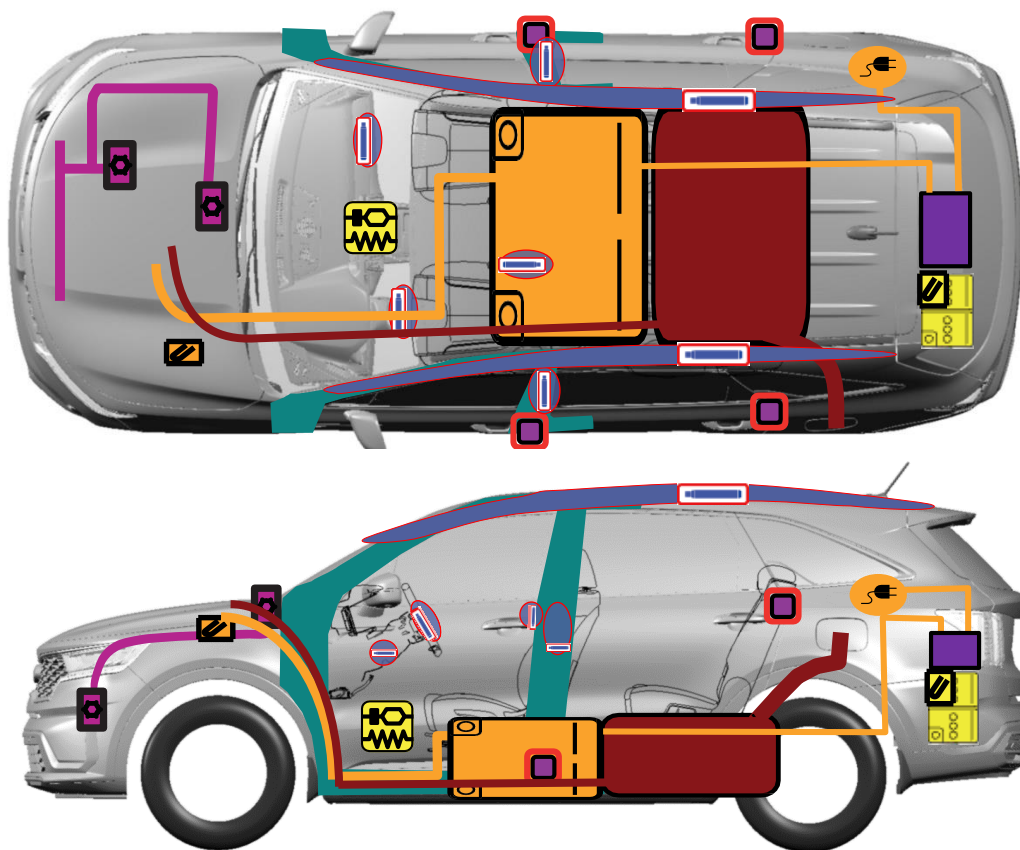





4. Access to the occupants

4.5 Occupants Rescue Guide

When dealing with an emergency situation, refer to the components as below.

Do not cut the body near the airbag, high voltage cable, fuel system.



 Supplemental Restraint System Control Module (SRSCM)	 Airbag	 Airbag Inflator
 High voltage cable	 Seat belt pretensioner	 Air-conditioning line
 Service Plug	 12V battery (-) connector	 Ultra-High Strength Steel
 High Voltage Battery	 Air-conditioning component	 Gasoline fuel tank & Line
 OBC (On-Board charger)	 12V battery	 High voltage charge port

5. Stored Energy / Liquid / Gases / Solids

5.1 High Voltage System

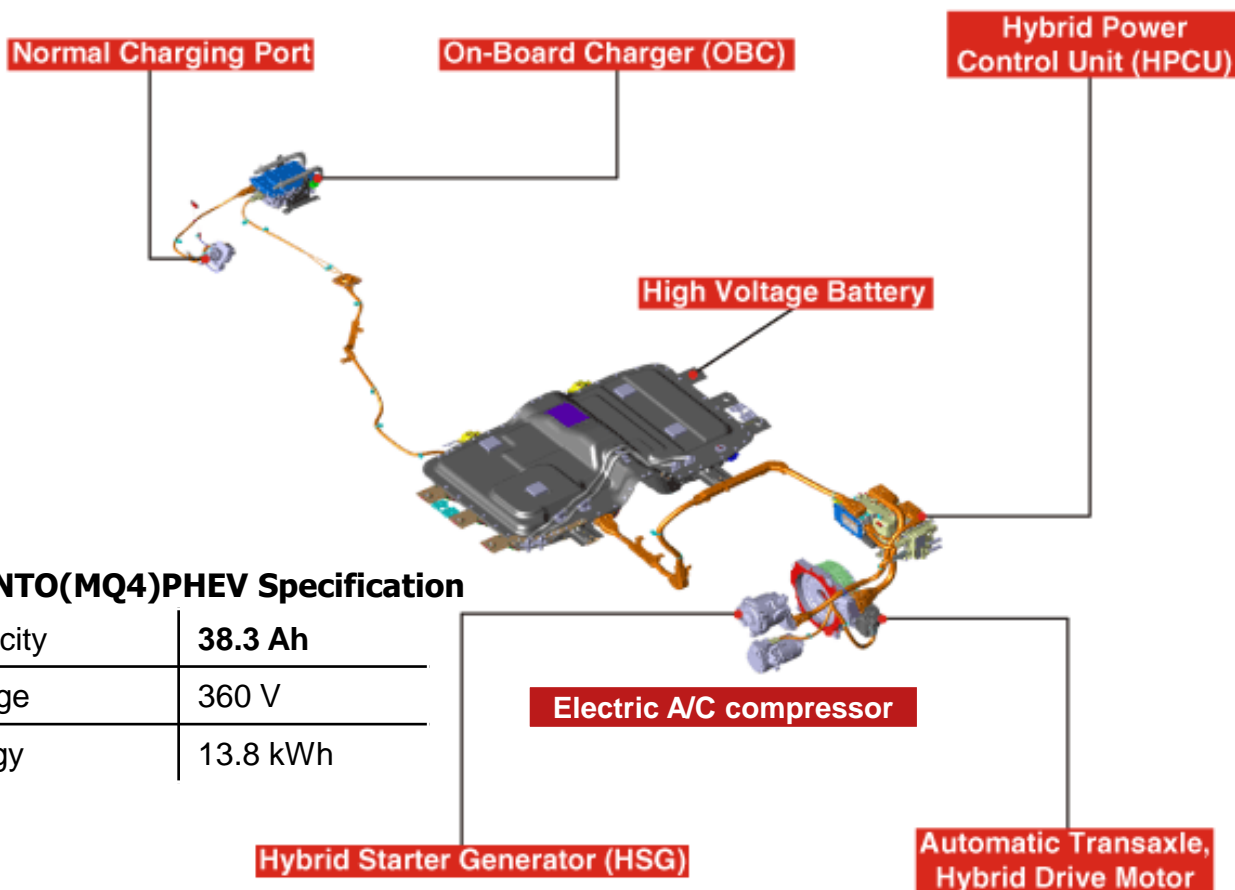

SORENTO(MQ4)PHEV Specification

Capacity	38.3 Ah
Voltage	360 V
Energy	13.8 kWh

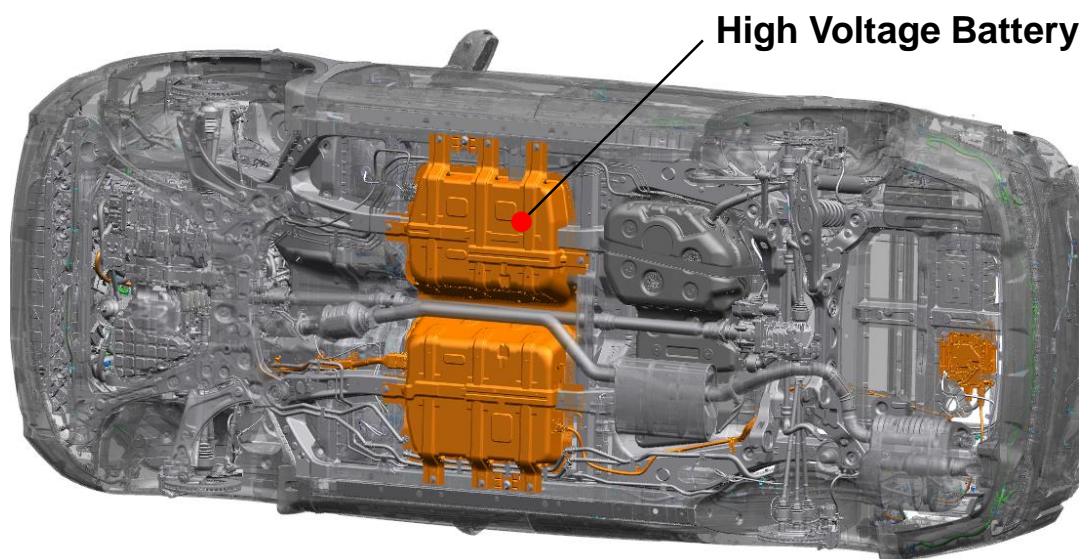

5. Stored Energy / Liquid / Gases / Solids

5.1 High Voltage System

Motor

The motor of the PHEV converts electrical energy into motive force with a Max. power of 59.3Hp (44.2kW) and Max. torque of 195lb-ft (264Nm).



HPCU

The HPCU includes an Inverter and LDC (Low Power DC-DC Converter) in one housing. The inverter converts DC to AC to supply electricity to the motor.

It also converts AC to DC to charge the high voltage battery. The LDC transfers high voltage electricity to a 12 volt system to charge 12V auxiliary battery.

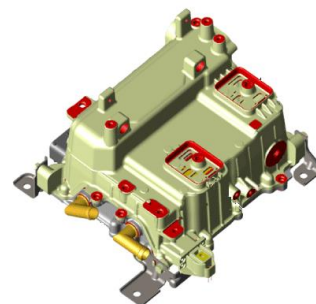

PHEV – High Voltage Battery

High voltage battery modules supply and store electric energy from the traction motor. The battery is a lithium-ion polymer battery with the following specifications:

360V / 38.3Ah / 13.8kWh.



HSG (Hybrid Starter Generator)

The HSG restarts the engine in the ICE/HEV modes, and also charges the high voltage battery while driving, acting as the generator for the hybrid vehicle.

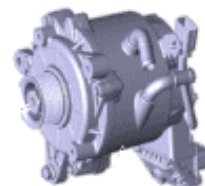

On-Board Charger (OBC)

The OBC is the battery charging equipment that converts external AC to DC to charge the high voltage battery.

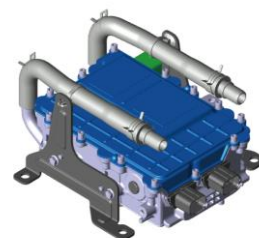

5. Stored Energy / Liquid / Gases / Solids

5.2 High Voltage Orange Cabling

The high voltage cabling is orange, per Society of Automotive Engineers (SAE) standards. Cables run under the floor of the vehicle and connect the high voltage battery to the HPCU, Motor, LDC, Inverter, OBC, A/C compressor and other high voltage components located towards the front of the vehicle.

The presence of orange cables under the hood, in the under-floor battery compartment, or HV cables under the car, identifies the vehicle as an PHEV vehicle.

CAUTION High Voltage Cables

- *Never cut or disconnect the high voltage orange cabling and connectors without first disabling the HV system by removing the safety plug (refer to page 11).*
- *Exposed cables or wires may be visible inside or outside the vehicle. Never touch the metal chassis wires, cables, connectors, or any electric components before disabling the system.*

Failure to follow these instructions will lead to serious bodily injury or death by electrical shock.

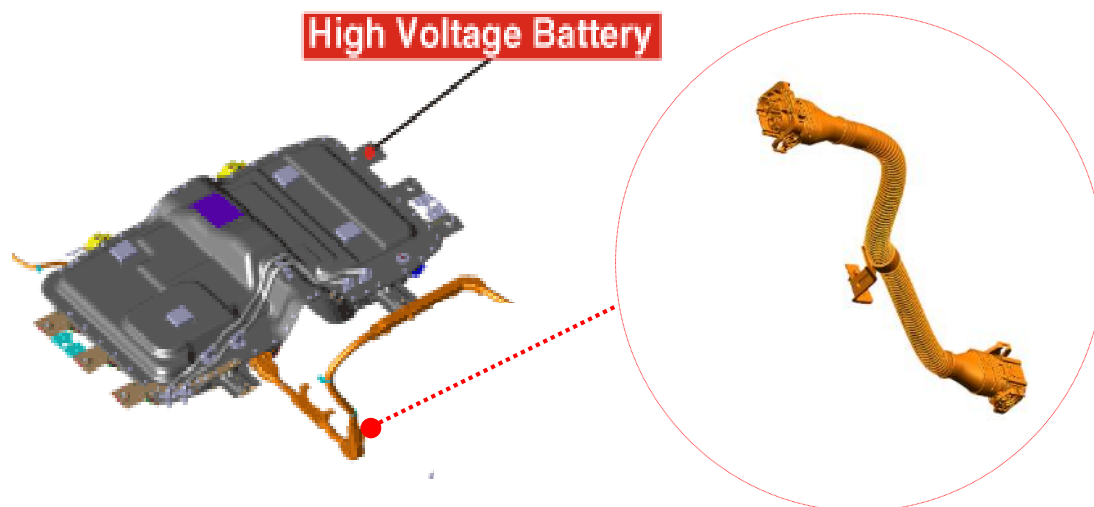

5. Stored Energy / Liquid / Gases / Solids

5.3 Fuel (Gasoline)

Sorento PHEV has a 1.6L 4-cylinder engine. The fuel type is gasoline that is stored in the fuel tank and delivered through the fuel line. When dealing with an emergency situation, be careful not to cut the fuel line and tank.

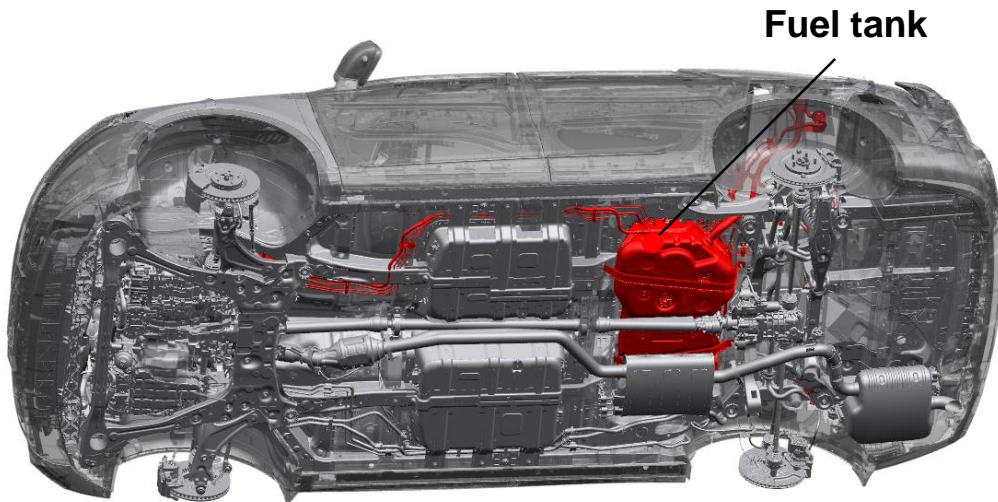
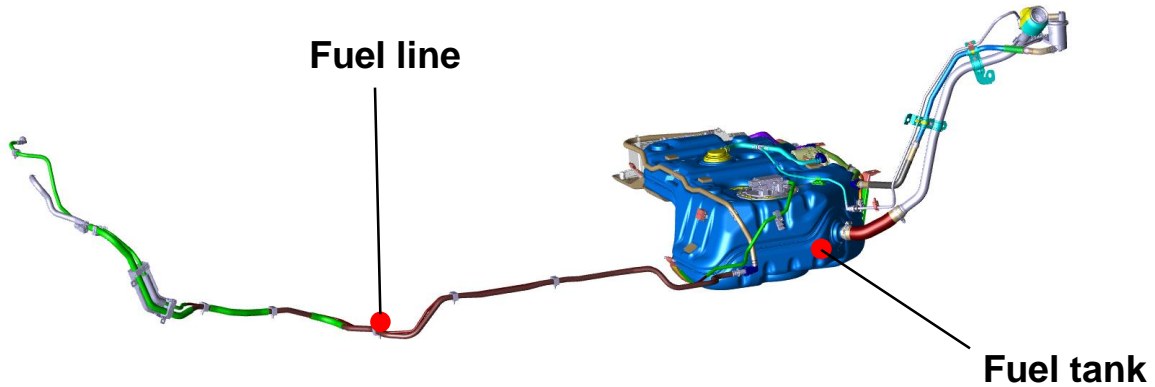

6. In Case of Fire

6.1 Firefighting Operations

Strict precautions must be taken while conducting firefighting operations due to following reasons:

- Lithium-ion Polymer batteries contain gel electrolyte that can vent, ignite, and produce sparks when subjected to temperatures above 300°F.
- Vehicle may burn rapidly with a flare-burning effect.
- Even after the high-voltage battery fire appears to have been extinguished, renewed or delayed fire can occur.
 - Use a thermal imaging camera to ensure the high voltage battery is completely cooled before leaving the incident.
 - Always advise second responders that there is a risk of the battery re-igniting.
 - In a fire, submersion or a collision that has compromised the high voltage battery, always store it in an open area with no exposures within 50 feet.
- A burning battery could release hydrogen fluoride, carbon monoxide, and carbon dioxide gasses. Use NIOSH/MSHA approved full-face self-contained breathing apparatus (SCBA) with full protective gear. Even if the high voltage battery pack is not directly involved in a vehicle fire, approach the vehicle very carefully.

6.2 Extinguishers

- Small fires that do not involve the high voltage battery should be extinguished using an ABC fire extinguisher. (ex. Fire caused by wiring harnesses, electrical components, etc.)
- Do not attempt to extinguish fires that involve the high voltage battery with small amounts of water as this can result in electrocution. Fires that involve the high voltage battery should be extinguished using large amounts of water (Max 100,000 liter) to cool the high voltage battery. Fire fighters should not hesitate to pour larger amounts of water on the vehicle in such scenarios. Make sure the battery is fully cooled to avoid fire re-ignition.

6. In Case of Fire

6.3 How to Deal With the Situation

Fire

Extinguish the fire with a large amount of water. Don't use seawater or salt water. Use of such water can generate toxic vapors or cause re-ignition.

Damaged battery or Fluid leak*

Disconnect 12V Battery (-) terminal, Disable the high voltage system, Neutralize the battery by applying a large volume of water. (Process will not discharge the battery.)

Battery discharging

*To be used if electrolyte solution leakage or damage to the high voltage battery casing is observed.

6.3.1 Vehicle Fire

- Use a large volume of water (max. 100,000 liter). Water must cool down the battery.
- If water is applied directly onto the high voltage battery module inside the casing, it will better cool the battery. (But, never attempt to penetrate the HV battery or its casing to apply water.)



- Putting water into the high voltage battery can be difficult due to the battery case.
- Put water through the hole that might be made due to the accident or fire.



6. In Case of Fire

6.3.2 High Voltage Battery Damage and Fluid Leaks

If electrolyte solution leakage or any damage to the Lithium ion battery casing is observed, the first responders should attempt to neutralize the battery by applying a large volume of water to the battery pack while wearing appropriate Personal Protective Equipment (PPE). The neutralization process helps stabilize the thermal condition of the battery pack but does not discharge the battery.

- Do not put any smoke, spark, flame around the vehicle.
- Do not touch or step on the spilled electrolyte.
- If electrolyte leak occurs, wear appropriate solvent resistant PPE and use soil, sand, or a dry cloth to clean up the spilled electrolyte. Be sure to adequately ventilate the area.



CAUTION

Electrolyte Irritation

The high voltage battery contains electrolyte solution. To avoid exposure to electrolyte solution and serious personal injury, always wear appropriate solvent resistant PPE (Personal Protective Equipment) and SCBA (Self-Contained Breathing Apparatus).

- *Electrolyte solution is an eye irritant. In the event of contact with eyes, rinse with plenty of water for 15 minutes.*
- *Electrolyte solution is a skin irritant. Therefore, in the event of contact with skin, wash off with soap.*
- *Electrolyte liquid or fumes coming into contact with water will create vapors in the air from oxidization. These vapors may irritate skin and eyes. In the event of contact with vapors, rinse with plenty of water and consult a doctor immediately.*
- *Electrolyte fumes (when inhaled) can cause respiratory irritation and acute intoxication. Inhale fresh air and wash mouth with water. Consult a doctor immediately.*

6. In Case of Fire

6.4 High Voltage Battery Re-ignition by Stranded Energy

Damaged cells in the high voltage battery can experience thermal runaway* and re-ignition. To prevent re-ignition, the first responder and second responder need to be aware of the risk of stranded energy* which remains in the damaged cells and can lead to re-ignition.

*Thermal runaway : The originating cause of thermal runaway is generally short-circuiting inside a battery cell and a resulting increase in the cell's internal temperature. Battery produces heat with thermal runaway and it can spread from one battery cell to many cells, in a domino effect.

*Stranded energy : Energy remains inside any undamaged battery cells after the accident. Stranded energy can cause a high voltage battery to re-ignite multiple times after a fire has been extinguished.

How to Prevent Re-ignition (Mitigating Stranded Energy Risk)

1. 12V battery (-) terminal disconnection (To depower battery management system)
2. High voltage shut off
*refer to page 11
3. Discharging the high voltage battery
*refer to page 27-28

7. In Case of Submersion

7.1 Submerged or Partially Submerged Vehicles

Some emergency responses can involve a submerged vehicle. The Sorento PHEV does not have high voltage components on the vehicle's body or framework. It is safe to touch the vehicle's body or framework if there is no severe damage to the vehicle, whether it is in water or on land.

In the event that the vehicle is submerged or partially submerged, remove the vehicle from the water before attempting to disable the vehicle. Drain the water from the vehicle. Use one of the methods described in page 9-13 to disable the vehicle.

Then, discharge the battery by referring to page 27-28

CAUTION

- *If severe damage causes high voltage components to become exposed, responders should take appropriate precautions and wear appropriate insulated personal protective equipment.*
- *Do not attempt to remove a safety plug while the vehicle is in water.*

Failure to follow these instructions can lead to death or serious injury by electrocution.

8. Towing / Transportation / Storage

8.1 Towing and Transportation

In the event of an accident, the high voltage system must be disabled. The safety plug must be removed from the high voltage battery according to one of the methods described in page 9-13 to disable the vehicle.

Towing the Sorento PHEV Vehicle is not different from towing a conventional AWD vehicle.

If emergency towing is necessary, we recommend having it done by an authorized Kia dealer or a commercial tow-truck service.

Proper lifting and towing procedures are necessary to prevent damage to the vehicle.

The use of wheel dollies or flatbed is recommended.

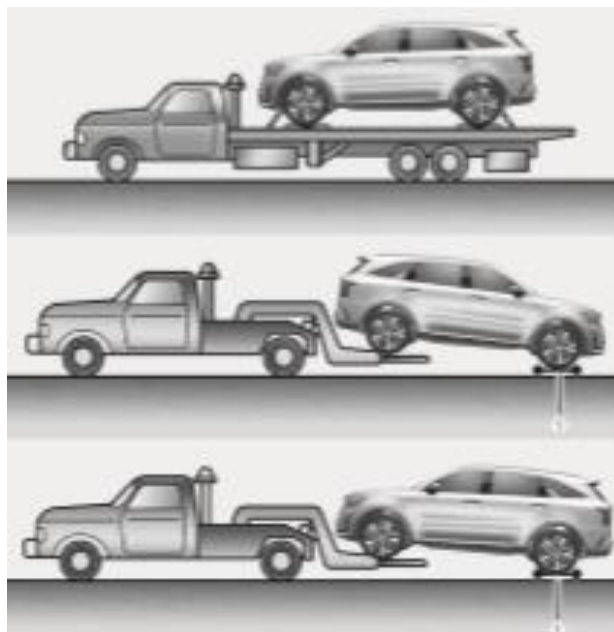

CAUTION

- *Do not tow with sling-type equipment. Use wheel lift or flatbed equipment.*
- *Never tow the vehicle with the front wheels on the ground (forward or backward), as this may cause fire or damage to the motor.*



8. Towing / Transportation / Storage

8.2 Storage of Damaged Vehicle with a Damaged Battery (Discharge)

- Drain fluids and water, then disconnect the negative (-) terminal of the 12 V battery.
- In addition, remove the water inside the battery or vehicle, then remove the service plug from the high voltage battery before storing a damaged vehicle.
- Place the vehicle in an open space away from any structure, vehicle, or building.
- Then, keep on eye on the vehicle until the discharging procedures are completed.
- **If the battery can be removed from the vehicle by moving the vehicle on the lift, remove and discharge the battery. (refer to the next page)**
- **If the battery can't be removed, set the water pool and pouring water until the entire battery is submerged.**

Water pool condition : tap water or pond water that does not contain salt

- Maintain this water level for at least 90 hours.
- Then, put salt into the water pool to make 3.5 % salt water.
- Wait for additional 48 hours in salt water.
- Drain the water and dry it.

CAUTION **Battery Discharging**

- *DO NOT USE SALT WATER for the first step.*
- *A large volume of flammable hydrogen gas can be generated in salt water due to electrolysis.*
- *After submerging the vehicle in pure water for at least 90 hours, put salt in the water pool.*

Battery discharging in the water pool

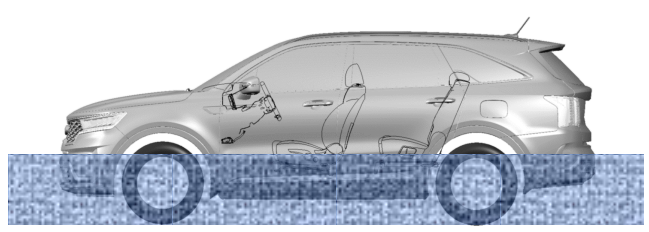

8. Towing / Transportation / Storage

8.3 Damaged Battery Storage

- To store the damaged battery safely, the battery must be discharged.
- If the battery can be removed from the vehicle, discharge the battery to prevent re-ignition.

CAUTION

- *Extinguish all smoke, spark, flame around the vehicle.*
- *Electrolyte solution is a skin irritant.*
- *Do not touch or step on the spilled electrolyte.*
- *If electrolyte leak occurs, wear appropriate solvent resistant PPE and use soil, sand, or a dry cloth to clean up the spilled electrolyte. Be sure to adequately ventilate the area.*

- Prepare water that does not contain salt such as tap water or pond water.
- Leave the battery in water for at least 90 hours.
- Then, put salt in water to make 3.5% salt water.
- Wait for additional 48 hours in salt water.
- Take out the battery from the container and dry it.

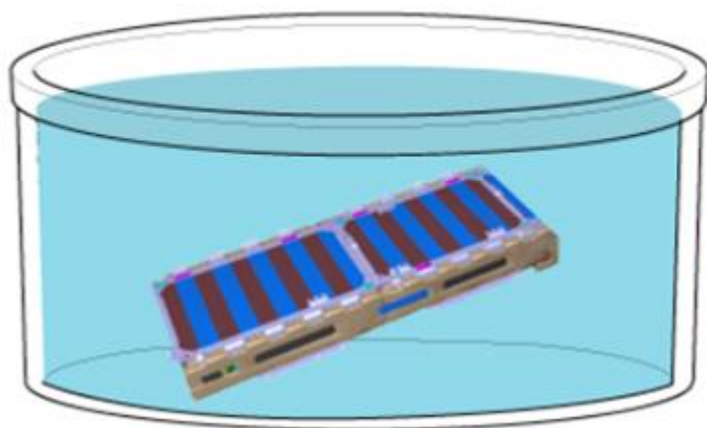

9. Important Additional Information

9.1 Emergency Starting

Jump Starting

Do not attempt to jump start the high voltage battery, as it cannot be jump started. In case of full discharge of the high voltage battery, the vehicle must be towed as mentioned on the previous page.

In case the 12V auxiliary battery is discharged, connect a starting device to the jump terminal in the engine room as you would any 12V battery (see image). Refer to the “Emergency Starting” section of the Owner’s Manual for additional information. Connect jumper cables in the order shown in the image and disconnect in reverse order.

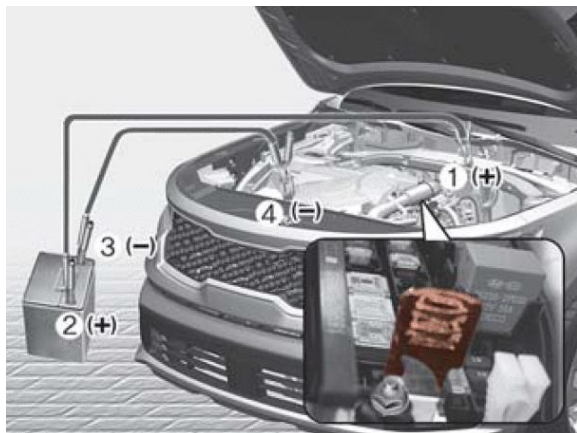

CAUTION

Do not attempt to jump start the Sorento high voltage battery.

Failure to follow these instructions will lead to serious bodily injury or death by electrical shock.

Jump Starting Procedure

1. Make sure the booster battery is 12-Volt and that its negative terminal is grounded.
2. If the booster battery is in another vehicle, do not allow the vehicles to come in contact.
3. Turn off all unnecessary electrical loads.
4. Connect the jumper cables in the exact sequence shown in the illustration.

First connect one end of a jumper cable to the positive terminal of the fuse box (1), then connect the other end to the positive terminal on the booster battery (2).

Proceed to connect one end of the other jumper cable to the negative terminal of the booster battery (3), then the other end to a solid, stationary, metallic point away from the fuse box (4).

9. Important Additional Information

9.2 Airbag System (SRS : Supplemental Restraint System)

Airbag

Seven (7) airbags are installed in the Sorento PHEV, located in the areas shown in the image below. Before performing any emergency procedure, make sure the vehicle ignition switch is turned off and disconnect the negative connector from the 12V auxiliary battery (located in the left side engine compartment) to prevent accidental deployment of undeployed airbags.

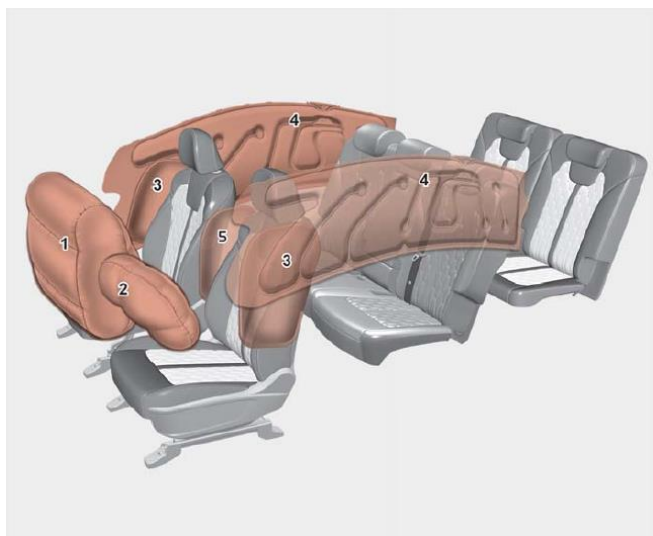

- (1) Passenger's front air bag
- (2) Driver's front air bag
- (3) Side air bags (x2)
- (4) Curtain air bags (x2)
- (5) Driver's center air bag

* The actual air bags and seats in the vehicle may differ from the illustration.

Seat Belt Pretensioner

In the Sorento PHEV, the driver's, front passenger's and rear seat belts are equipped with pretensioners. When the seat belt pretensioners are activated in a collision, a loud noise may be heard and fine dust, which may appear to be smoke, may be visible in the passenger compartment. These are normal operating conditions and are not hazardous. The seat belt pretensioner assembly mechanisms may become hot during activation, and may need several minutes to cool down after they have been activated.

9. Important Additional Information

Seat Belt System



Seat Belt Pretensioner (BPT)

CAUTION Undeployed Airbags

To avoid injuries caused by accidental deployment of undeployed airbags

- Do not cut the red colored part shown in the image above.
- Make sure the vehicle ignition switch is turned off, disconnect the negative cable from the 12V auxiliary battery (located in the left side of engine room) and wait 3 minutes or longer to allow the system to deactivate.

Failure to follow any of these instructions may result in serious injury or death from accidental deployment of the airbag system.